

Volocity User Guide



Improvision,
A PerkinElmer Company,
Viscount Centre II,
University of Warwick Science Park,
Millburn Hill Road,
Coventry, CV4 7HS
T +44 (0) 24 7669 2229
F +44 (0) 24 7669 0091
E admin@improvision.com
Internet: <http://www.improvision.com>

Printing History

Document Edition	Date	About this edition
1.0	January 2001	The first edition of the Volocity for Macintosh User's Guide.
2.0	March 2001	Updated to include information about installing and using Volocity on a Windows PC.
3.0	June 2001	Updated to include more information about library formats, creating QuickTime movies and other minor amendments.
4.0	July 2001	Updated to include information about the Volume Sequencer.
5.0	September 2001	Updated to include information about Measurements.
6.0	December 2001	First printed edition.
7.0	June 2002	Updated to include information about Classifier.
8.0	December 2002	Updated to reflect new structure of software modules: Volocity LE, Volocity Visualization, Volocity Restoration and Volocity Classifier. Major additions to Classifier and new palette, Voxel Spy.
9.0	November 2003	Updated for Volocity 2.5 and to include information about the Improvion License Server for both the client user and server system administrator.
10.0	January 2005	Updated for Volocity 3.0. Transferred information about the Improvion License Server for the server system administrator to a separate guide.
11.0	May 2005	Updated for Volocity 3.5. Added Volocity Acquisition chapter and Colocalization to Volocity Classification chapter.
12.0	August 2005	Updated for Volocity 3.6. Changes to Classifier setup dialog and palette and added FRET and ratio analysis. Changes to Navigation palette and Visualization chapter, to Acquisition chapters and to Restoration chapter.
13.0	January 2007	Updated for Volocity 4.0. New Quantitation chapter. Changes to Visualization chapter. Major reorganization of content to facilitate generation of Help files, accessed within product.
14.0	April 2007	Updated for Volocity 4.1.
15.0	October 2007	Updated for Volocity 4.2.
16.0	February 2008	Updated for Volocity 4.3.
17.0	November 2008	Updated for Volocity 5.0.
18.0	June 2009	Updated for Volocity 5.2.
19.0	December 2009	Updated for Volocity 5.3.

PerkinElmer believes the information in this manual to be correct at the date of issue.

However, it is subject to change at any time and does not represent a commitment on the part of Improvion. Improvion shall not be liable for errors contained herein or for incidental or consequential damages in connection with the furnishing, performance, or use of this manual. Improvion has a policy of continual development and reserves the right to change information within this manual without notice to reflect changes in the system's design and specification.

© 2001-2009 PerkinElmer.

All rights reserved.

CUSTOMER SOFTWARE LICENSE THE LICENSE (USA)

Image Processing and Vision Company Limited (trading as Improvision) (the "Licensor", which expression shall include its subsidiaries, agents, successors and assigns) is authorized to license the software, documentation and any fonts contained in this package (the "Software") and upon opening the sealed package containing the Software, the Licensee accepts a non-exclusive License to "Use" (as hereinafter defined) the Software on a single computer system (the "System") for single use specified below upon the terms and subject to the conditions contained herein. The Licensee owns the media on which the Software is recorded, but the Licensor retains title to the Software.

This License entitles the Licensee to:

- (a) load, install and Use the Software contained in this package on one Central Processing Unit ("CPU") of the System (a separate LICENSE fee being required for each CPU upon which the Licensee wishes to use the Software)
 - (b) Use the Software in accordance with the provisions of Section 2 of this License;
- and, where the Licensee signs and returns the warranty card enclosed with the Software, to:
- (a) receive telephone technical support relating to the Software during the Licensor's usual business hours, within the period of the software maintenance agreement;
 - (b) receive information on upgraded versions of the Software at such cost (if any) as may be notified to the Licensee.

1. Acceptance of this LICENSE

The terms and conditions of this License are deemed to be accepted:

- (a) by the Licensor upon dispatch/delivery by the Licensor of this package to the Licensee; and
- (b) by the Licensee by breaking the seal of this sealed package containing the Software; or
- (c) by the Licensee signing and returning the enclosed warranty card.

2. Use of the Software

- (a) For the purposes of this License "Use" shall mean and include:
 - (i) utilization of the Software by copying, transmitting or loading the same into the temporary memory (RAM) or installing into the permanent memory (e.g. hard disk, CD ROM or other storage device) of the System for the processing of the System instructions or statements contained in such Software;
 - (ii) copying the Software which is in machine-readable form for Use by the Licensee on the System for the purposes only of understanding the contents of such machine-readable material and for back-up provided that (A) no more than one (1) non-transient copy will be in existence under this License at any one time without prior written consent from the Licensor or as otherwise permitted by the applicable law, and (B) such backup copy includes all copyright information contained on the original;

- (iii) storing the whole or any part of the Software on the System or other storage unit or disk; and
- (iv) utilizing (but not copying) the instructional and/or operational manuals relating to the Software.

- (b) The Licensee acknowledges and accepts that the Software is protected against unauthorized use by means of a serial number.
- (c) The Licensee shall also be permitted to Use the Software on a portable, lap-top or home computer where the Software is permanently installed on the hard disk or other storage device of the System (but not a file server) and the Licensee or its relevant employee as the case may be is the predominant user of the Software and such Use will not breach the concurrent user limit where applicable.
- (d) THE SOFTWARE IS NOT INTENDED FOR USE IN THE OPERATION OF NUCLEAR FACILITIES, AIRCRAFT NAVIGATION OR COMMUNICATION SYSTEMS, OR AIR TRAFFIC CONTROL MACHINES IN WHICH CASE THE FAILURE OF THE SOFTWARE COULD LEAD TO DEATH, PERSONAL INJURY, OR SEVERE PHYSICAL OR ENVIRONMENTAL DAMAGE.
- (e) The Licensee's rights under this License will terminate automatically without notice from the Licensor if the Licensee fails to comply with any term(s) of this License.

3. License Fee

- (a) Where the License Fee has not been paid by the Licensee at the time the Software is obtained from the Licensor or its agent the License Fee will be payable

4. Improvision

within the number of days specified in the Licensor's invoice unless otherwise agreed to in writing by the Licensor.

- (b) An additional License Fee is payable for each CPU of the System upon which the Licensee wishes to Use the Software. In the event that the Licensee's System is inoperable, the Licensee shall be permitted to Use the Software on a back-up system at no extra charge, until the System is operational.

4. Licensee's Undertakings

- (a) The Licensee undertakes not to perform any of the acts referred to in this sub-clause (a) except to the extent and only to the extent required by the applicable law as applied to the Licensee as a lawful user (i.e. a party with a right to use) of the Software and only then for the specific limited purpose stated in such applicable law or hereunder.

The Licensee undertakes:

- (i) not to copy the Software (other than for normal System operation and as specified in Section 2 above) nor otherwise reproduce the same provided that the Licensee may copy the Software for back-up or archival purposes or incidentally, in the course of converting the Software in accordance with Section 4(a)(iii) below;
- (ii) not to translate, adapt, vary, or modify the Software or its source or object code;
- (iii) subject to subsection (iv) below, without the Licensor's prior written consent, not to disassemble, decompile, reverse engineer, modify, or create

derivative works based on the Software in whole or in part or transmit the Software over a network, provided however that in the case of decompilation, the Licensee may incidentally decompile the Software only if it is essential to do so in order to achieve interoperability of the Software with another software program ("Permitted Purpose") and provided the information obtained by the Licensee during such decompilation is only used for the Permitted Purpose and is not disclosed or communicated to any third party to whom it is not necessary to disclose or communicate such information and it is not used to create any software which is substantially similar to the Software or the expression of the Software nor used in any manner which would be restricted by copyright.

- (iv) It shall be a condition precedent to the decompilation of the Software permitted in accordance with the terms referred to in subsection (iii) above, that the Licensee shall have notified the Licensor in writing (a) that it wishes to perform the decompilation; (b) the purposes for which it wishes to perform the decompilation; and (c) the information which it requires for such purposes. Only when the Licensor has either (a) not responded within a reasonable time or (b) has not offered to provide the Licensee with information required under (c) above (for which the Licensor may require payment) shall the Licensee be permitted to continue with the decompilation.

The Licensee undertakes:

- (b) to maintain accurate and up-to-date records of the number and location of all copies of the Software.
- (c) to supervise and control Use of the Software in accordance with the terms of this License.
- (d) to ensure that its employees, agents and other duly authorized parties who will use the Software (including any transferee of the Software) are notified of this License and the terms hereof prior to such use.
- (e) to reproduce and include the copyright notice of the Licensor or such other party as may be specified in or on the Software (the "Owner") on all and any copies, whether in whole or in part, in any form, including partial copies or modifications of the Software made herein.
- (f) not to provide or otherwise make available the Software in whole or in part (including where applicable, but not limited to program listings, object code and source program listings, object code and source code), in any form to any person other than the Licensee's employees or as specified in (d) above without prior written consent from the Licensor.
- (g) within 14 days after the date of termination or discontinuance of this License for whatever reason, to destroy the Software and all updates, upgrades or copies, in whole and in part, in any form including partial copies or modifications of the Software received from the Licensor or made in connection with this License, and all documentation relating thereto and certify in writing that the Licensee has complied with this subsection.

5. Disclaimer of Warranty

The Licensee acknowledges and agrees that use of the Software is at the Licensee's sole risk. The Software is provided "AS IS" and without warranty of any kind and the Licensor and Licensor's licensor(s) (for the purposes of Sections 5 and 6, Licensor and Licensor's licensor(s) shall be collectively referred to as "Licensor") EXPRESSLY DISCLAIM ALL WARRANTIES AND/OR CONDITIONS, EXPRESS OR IMPLIED, INCLUDING, BUT NOT LIMITED TO, THE IMPLIED WARRANTIES AND/OR CONDITIONS OF MERCHANTABILITY OR SATISFACTORY QUALITY AND FITNESS FOR A PARTICULAR PURPOSE AND NONINFRINGEMENT OF THIRD PARTY RIGHTS. THE LICENSOR DOES NOT WARRANT THAT THE FUNCTIONS CONTAINED IN THE SOFTWARE WILL MEET THE LICENSEE'S REQUIREMENTS, OR THAT THE OPERATION OF THE SOFTWARE WILL BE UNINTERRUPTED OR ERROR-FREE, OR THAT DEFECTS IN THE SOFTWARE WILL BE CORRECTED. FURTHERMORE, LICENSOR DOES NOT WARRANT OR MAKE ANY REPRESENTATIONS REGARDING THE USE OR THE RESULTS OF THE USE OF THE SOFTWARE OR RELATED DOCUMENTATION IN TERMS OF THEIR CORRECTNESS, RELIABILITY, OR OTHERWISE. NO ORAL OR WRITTEN INFORMATION OR ADVICE GIVEN BY THE LICENSOR OR A LICENSOR AUTHORIZED REPRESENTATIVE SHALL CREATE A WARRANTY OR IN ANY WAY INCREASE THE SCOPE OF THIS WARRANTY. SHOULD THE SOFTWARE PROVE DEFECTIVE, LICENSEE (AND NOT LICENSOR OR A LICENSOR AUTHORIZED REPRESENTATIVE) SHALL ASSUME THE ENTIRE COST OF ALL NECESSARY SERVICING, REPAIR OR CORRECTION. SOME JURISDICTIONS DO NOT ALLOW THE EXCLUSION OF IMPLIED WARRANTIES, SO THE ABOVE EXCLUSION MAY NOT APPLY TO YOU. THE

TERMS OF THIS DISCLAIMER DO NOT AFFECT OR PREJUDICE THE STATUTORY RIGHTS OF A CONSUMER ACQUIRING LICENSOR PRODUCTS OTHERWISE THAN IN THE ORDINARY COURSE OF BUSINESS, NEITHER DO THEY LIMIT OR EXCLUDE ANY LIABILITY FOR DEATH OR PERSONAL INJURY CAUSED BY LICENSOR'S NEGLIGENCE.

6. Licensor's Limitation of Liability

THE LICENSOR SHALL NOT BE LIABLE TO THE LICENSEE FOR ANY LOSS OR DAMAGE, EXCEPT AS SPECIFICALLY SET FORTH IN THIS AGREEMENT, ARISING DIRECTLY OR INDIRECTLY IN CONNECTION WITH THIS LICENSE, THE SOFTWARE, ITS USE OR OTHERWISE. NOTWITHSTANDING THE GENERALITY OF THE FOREGOING, THE LICENSOR EXPRESSLY EXCLUDES LIABILITY FOR NEGLIGENCE, INDIRECT, SPECIAL, INCIDENTAL OR CONSEQUENTIAL LOSS OR DAMAGE WHICH MAY ARISE IN RESPECT OF THE SOFTWARE, ITS USE, THE SYSTEM OR IN RESPECT OF OTHER EQUIPMENT OR PROPERTY, OR FOR LOSS OF PROFIT, BUSINESS, REVENUE, GOODWILL OR ANTICIPATED SAVINGS. LIABILITY OF THE LICENSOR AND ITS SUPPLIERS TO THE LICENSEE, IF ANY, FOR BREACH OF WARRANTY ARISING OUT OF CONTRACT, NEGLIGENCE OR STRICT LIABILITY IN TORT, OR ANY OTHER CLAIM RELATING TO THIS LICENSE, OR IN THE EVENT THAT ANY EXCLUSION CONTAINED IN THIS LICENSE SHALL BE HELD TO BE INVALID FOR ANY REASON AND THE LICENSOR BECOMES LIABLE FOR LOSS OR DAMAGE, SHALL BE LIMITED TO FIFTY DOLLARS (\$50.00).

7. Copyrights Patents, Trade Marks and Other Intellectual Property Rights

The Licensee acknowledges that any and all of the copyright, trade marks, trade names, patents and other

6 Improvisation

intellectual property rights subsisting in or used in connection with the Software including all documentation and manuals relating thereto are and remain the sole property of the Licensor and the Owner. The Licensee shall not during or at any time after the expiration or termination of this License in any way question or dispute the ownership by the Licensor and/or the Owner thereof.

8. Indemnity

- (a) The Licensor agrees to indemnify and save harmless and defend at its own expense the Licensee from and against any and all claims of infringement of any patent, trade mark, industrial design, copyright or other proprietary right affecting the Software provided that (i) the Licensee shall not have done, permitted or suffered to be done anything which was not expressly authorized by this License or which may have been or become an infringement of any such rights (including but not limited to using the Software to perform the Licensee's or other party's applications or using the Software in combination or merged with other software programs or devices) and (ii) the Licensee shall have exercised a commercially reasonable standard of care in protecting the same; failing which, the Licensee shall indemnify the Licensor against all actions, proceeding costs, claims and expenses incurred in respect thereof.
- (b) In the event that any such infringement occurs or may occur, the Licensor may at its sole option and expense:
- (i) procure for the Licensee the right to continue using the Software or infringing part thereof; or
 - (ii) modify or amend the Software or infringing part thereof so that the same becomes non-infringing; or
 - (iii) replace the Software or infringing part thereof by other software of similar capability; or
 - (iv) repay to the Licensee the License Fee or balance thereof relating to the whole or the infringing part of the Software.
- (c) The Licensor's obligations under subsection (a) or (b) above are expressly conditioned upon and subject to:
- (i) the Licensor having sole control of the defense and/or settlement of any such infringement claim;
 - (ii) the Licensee promptly notifying the Licensor in writing of any claim specified in subsection (a) above that is made against the Licensee and providing the Licensor with the authority to proceed as set forth in (i) above; and
 - (iii) the Licensee providing the Licensor with all information known to the Licensee relating to such infringement claim and otherwise providing the Licensor with such assistance as the Licensor may reasonably require to settle or oppose any such claims.
- (d) The Licensor's liability under this clause shall, at the Licensor's option, be limited to the License Fee, less an equitable proportion thereof, as relates to the period prior to cessation of the use of the Software by the Licensee because of such claims of infringement.

9. Confidential Information

- (a) All information, data, drawings, specifications, documentation, software listings, source or object code which the Licensor may have imparted and may from time to time impart to the Licensee relating to the Software (other than the ideas and principles which underlie the Software) is proprietary and confidential. The Licensee hereby agrees that it shall use the same solely in accordance with the provisions of this License and that it shall not at any time during or for a period of six years after expiration or termination of this License, disclose the same, whether directly or indirectly, to any third party without the Licensor's prior written consent.
- (b) The Licensee further agrees that it shall not itself or through any subsidiary, agent or third party use such confidential information to copy, reproduce, translate, adapt, vary, modify, decompile, disassemble or reverse engineer the Software nor shall the Licensee lease, license, sub-license or otherwise deal with the Software (other than by sale as specifically referred to in sub-clause (d) below) or any part or parts or variations, modifications, copies, releases, versions or enhancements thereof or have any software or other program written or developed for itself based on any confidential information supplied to it by the Licensor.
- (c) The foregoing provisions shall not prevent the disclosure or use by the Licensee of any information which is or hereafter, through no fault of the Licensee, becomes public knowledge or to the extent required by law.

8 Improvisation

- (d) The Licensee may sell this License provided that:
- (i) all copies of the Software held by the Licensee pursuant to this License shall either be destroyed or transferred to the Transferee on completion of the sale;
 - (ii) the Licensee procures written agreement by the Transferee accepting the terms of the License; and
 - (iii) the Licensee gives prior notice to the Licensor of the transfer and the identity and address of the Transferee and receives Licensor's prior written consent.

10. Force Majeure

The Licensor shall be under no liability to the Licensee in any way whatsoever for destruction, damage, delay or any other matters of any nature whatsoever arising out of war, rebellion, civil commotion, strikes, lock-outs or industrial disputes, fire, explosion, earthquakes, acts of God, flood, drought, bad weather or power outages; the unavailability of deliveries, supplies, software disks or other media or the requisitioning or other act or order by any government department, council or other constituted body.

11. Termination

- (a) This License shall terminate and any and all rights granted to the Licensee hereunder shall revert in the Licensor:
- (i) upon thirty (30) days written notice in the event that Licensee or any of its directors, officers, employees or agents is in breach of any term, condition or provision of this License and fails to remedy such breach (if capable of remedy) within such thirty (30) days; and

(ii) should the Licensee, its successors or permitted assigns, suspend business, make an absolute assignment of the bulk of its assets for the benefit of creditors, consent to the appointment of a trustee, custodian or receiver, or be declared insolvent or bankrupt; or if a trustee or custodian or receiver is appointed for the Licensee for a substantial part of its property without its consent and is not discharged within sixty (60) days of such appointment, or if bankruptcy, reorganization, rearrangement, insolvency or liquidation proceedings are instituted by or against the Licensee and are not dismissed within sixty (60) days of the commencement thereof.

(b) Upon termination, the Licensee shall pay to the Licensor all costs and expenses, including legal and other fees incurred and all arrearages of fees, charges or other payments arising in respect of the Software, this License or otherwise and shall comply with its undertaking specified in Section 4(g) above.

(c) Termination of this License shall be in addition to and not in lieu of any rights and remedies the Licensor may have under this License or under the applicable law. Notwithstanding the termination of this License, the provisions of Sections 6, 7, 9 and 13 through 19 shall survive such termination.

12. Assignment

The Licensee shall not assign, rent, lease, loan, sublicense, distribute, or otherwise transfer all or any part of the Software or this License without the prior written consent of the Licensor, in accordance with Section 9(d) above.

13. Waiver

Failure or neglect by either party to enforce at any time any of the provisions hereof shall not be construed nor shall be deemed to be a waiver of that party's rights hereunder nor in any way affect the validity of the whole or any part of this License nor prejudice that party's rights to take subsequent action.

14. Headings

The headings of the terms and conditions herein contained are inserted for convenience of reference only and are not intended to be part of or to affect the meaning or interpretation of any of the terms and conditions of this License.

15. Severability

In the event that any of these terms and conditions or provisions shall be determined by any competent authority to be invalid, unlawful or unenforceable to any extent, such term, condition or provision shall to that extent be severed from the remaining terms, conditions and provisions which shall continue to be valid to the fullest extent permitted by law.

16. Law

The parties hereby agree that the License concluded between them and constituted on these terms and conditions shall be construed in accordance with the law of the State of Massachusetts without regard to its conflict of laws principles.

17. Jurisdiction

In any legal action related to this License, the Licensee agrees (a) to the exercise of jurisdiction over it by a state or federal court in Boston, Massachusetts and (b) that all legal actions relating to this License shall be instituted in one of the courts specified in (a) above.

18. Export Law Assurances

The Licensee may not use or otherwise export or reexport the Software except as authorized by United States law and laws of the jurisdiction in which the Software was obtained. The Licensee agrees and certifies that (i) neither the Software nor any related documentation or product thereof is intended to be shipped, transferred or reexported, directly or indirectly, into any country prohibited by the United States Export Administration Act of 1979 and the regulations thereunder, as amended, nor will be used for any purpose prohibited by the Act, and (ii) that Licensee is not located in, under control of, or a national or a resident of a country on the U.S. Treasury Department's list of Specially Designated Nationals or the U.S. Department of Commerce's Table of Denial Orders. The Licensee agrees to comply with all laws and regulations pertaining to the export of the Software.

19. Restricted Rights

If any Software or related documentation is to be used by the United States government, it shall be provided with "Restricted Rights." Use, duplication or disclosure by the government is subject to restrictions set forth in subparagraph (C)(1)(ii) of the Department of Defense Regulations Supplement ("DFARS") 252.227-7013, Rights in Technical Data and Computer Software (October 1988), Federal Acquisition Regulation ("FAR") 52.227-14, Rights in Data-General, including Alternate III (June 1987), as applicable, and FAR 52.227-19. Supplier: Image Processing and Vision Company Limited, Viscount Centre II, University of Warwick Science Park, Millburn Hill Road, Coventry, CV4 7HS, England.

20. Complete Agreement

This License constitutes the entire agreement between the parties with respect to the use of the Software and supersedes all prior or contemporaneous understandings regarding such subject matter. No amendment to or modification of this License will be binding unless in writing and signed by the Licensor.

10 Improvisation

THE LICENCE (EUROPE)

Image Processing and Vision Company Limited (trading as Improvision) (the "Licensor" which expression shall include its subsidiaries, agents, successors and assigns) is authorised to license the software (the "Software") contained in this package and upon opening the sealed package the Licensee accepts a non-exclusive Licence to "Use" (as hereinafter defined) the Software on a single computer system (the "System") for single use specified below upon the terms and subject to the conditions contained herein.

This Licence entitles the Licensee to:

- (a) load, install and Use the Software contained in this package on one Central Processing Unit ("CPU") of the System (a separate licence fee being required for each CPU upon which the Licensee wishes to use the Software);
 - (b) Use the Software in accordance with the provisions of Clause 2 of this Licence;
- and, where the Licensee signs and returns the warranty card enclosed with the Software, to:
- (a) receive telephone technical support relating to the Software within the Licensor's usual business hours, within the period of the software maintenance agreement;
 - (b) receive information on upgraded versions of the Software at such cost (if any) as may be notified to the Licensee.

1. Acceptance of this Licence

The terms and conditions of this Licence are deemed to be accepted by the parties in any one of the following circumstances:

- (a) by the Licensor upon dispatch/delivery by the Licensor of this package to the Licensee direct or to the Licensor's agent as the case may be;
- (b) by the Licensee by breaking the seal of this sealed package containing the Software;
- (c) the Licensee signing and returning the enclosed warranty card.

2. Use of the Software

- (a) For the purposes of this Licence "Use" shall mean and include:
 - (i) utilization of the Software by copying, transmitting or loading the same into the temporary memory (RAM) or installing into the permanent memory (e.g. hard disk, CD ROM or other storage device) of the System for the processing of the System instructions or statements contained in such Software;
 - (ii) copying the Software which is in machine-readable form for Use by the Licensee on the System for the purposes only of understanding the contents of such machine-readable material and for back-up provided that no more than three (3) non-transient copies will be in existence under any Licence at any one time without prior written consent from the Licensor or as otherwise permitted by the applicable law;

(iii) storing the whole or any part of the Software on the System or other storage unit or disk;

(iv) utilizing (but not copying) the instructional and/or operational manuals relating to the Software.

(b) The Licensee acknowledges and accepts that the Software may be protected against unauthorised use by means of a dongle device.

(c) The Licensee shall also be permitted to Use the Software on a portable, lap-top or home computer where the Software is permanently installed on the hard disk or other storage device of the System (but not a file server) and the Licensee or its relevant employee as the case may be is the predominant user of the Software and such Use will not breach the concurrent user limit where applicable.

3. Licence Fee

(a) Where the Licence Fee has not been paid by the Licensee at the time the Software is obtained from the Licensor or its agent the licence fee will be payable within the number of days specified in the Licensor's invoice unless otherwise agreed in writing by the Licensor.

(b) An additional Licence Fee is payable for each CPU of the System upon which the Licensee wishes to Use the Software. In the event that the Licensee's System is inoperable or requires or is under repair, the Licensee shall be permitted to Use the Software on a back-up system at no extra charge, until the System is operational.

4. Licensee's Undertakings

(a) The Licensee undertakes not to perform any of the acts referred to in this sub-clause (a) except to the extent and only to the extent permitted by the applicable law to the Licensee as a lawful user (i.e. a party with a right to use) of the Software and only then for the specific limited purpose stated in such applicable law or hereunder. The Licensee undertakes:

(i) not to copy the Software (other than for normal System operation and as specified in Clause 2 above) nor otherwise reproduce the same Provided that the Licensee may copy the Software for back-up purposes or incidentally, in the course of converting the Software in accordance with 4(a)(iii) below;

(ii) not to translate, adapt, vary, modify the Software;

(iii) subject to sub-clause (iv) below not to disassemble, decompile or reverse engineer the Software Provided however that in the case of decompilation, the Licensee may incidentally decompile the Software only if it is essential so to do in order to achieve interoperability of the Software with another software program ("Permitted Purpose") and provided the information obtained by the Licensee during such decompilation is only used for the Permitted Purpose and is not disclosed or communicated to any third party whom it is not necessary to disclose or communicate such information without the Licensor's prior written consent and is not used to create any software

which is substantially similar to the expression of the Software nor used in any manner which would be restricted by copyright.

- (iv) It shall be a condition precedent to the decompilation of the software permitted in accordance with the terms referred to in sub-clause (iii) above that the Licensee shall have notified the Licensor in writing (a) that it wishes to perform the decompilation (b) the purposes for which it wishes to perform the decompilation and (c) the information which it requires for such purposes. Only when the Licensor has either (a) not responded within a reasonable time and (b) has not offered to provide the Licensee with the information required under (c) above (for which the Licensee may require payment) shall the Licensee be permitted to continue with the decompilation.

The Licensee undertakes:

- (b) to maintain accurate and up-to-date records of the number and location of all copies of the Software.
- (c) to supervise and control Use of the Software in accordance with the terms of this Licence.
- (d) to ensure that its employees, agents and other parties who will use the Software (including any transferee of the Software) are notified of this Licence and the terms hereof prior to such employee, agent or party using the same.
- (e) to reproduce and include the copyright notice of the Licensor or such other party as may be specified in or on the Software (the "Owner") on all and any copies,

whether in whole or in part, in any form, including partial copies or modifications of the Software made herein.

- (f) not to provide or otherwise make available the Software in whole or in part (including where applicable, but not limited to program listings, object code and source program listings, object code and source code), in any form to any person other than the Licensee's employees or as specified in (d) above without prior written consent from the Licensor.
- (g) within 14 days after the date of termination or discontinuance of this Licence for whatever reason, to destroy the Software and all updates, upgrades or copies, in whole and in part, in any form including partial copies or modifications of the Software received from the Licensor or made in connection with this Licence, and all documentation relating thereto.

5. Warranty

THE LICENSEE ACKNOWLEDGES THAT SOFTWARE IN GENERAL IS NOT ERROR-FREE AND AGREES THAT THE EXISTENCE OF SUCH ERRORS SHALL NOT CONSTITUTE A BREACH OF THIS LICENCE.

IN THE EVENT THAT THE LICENSEE DISCOVERS A MATERIAL ERROR WHICH SUBSTANTIALLY AFFECTS THE LICENSEE'S USE OF THE SAME AND NOTIFIES THE LICENSOR OF THE ERROR WITHIN 90 DAYS FROM THE DATE OF PAYMENT OF THE LICENCE FEE (THE "WARRANTY PERIOD") THE LICENSOR SHALL AT ITS SOLE OPTION EITHER REFUND THE LICENCE FEE OR USE ALL REASONABLE ENDEAVOURS TO CORRECT BY PATCH OR NEW RELEASE (AT ITS

OPTION) THAT PART OF THE SOFTWARE WHICH DOES NOT SO COMPLY PROVIDED THAT SUCH NON-COMPLIANCE HAS NOT BEEN CAUSED BY ANY MODIFICATION, VARIATION OR ADDITION TO THE SOFTWARE NOT PERFORMED BY THE LICENSOR OR CAUSED BY ITS INCORRECT USE, ABUSE OR CORRUPTION OF THE SOFTWARE.

THE LICENSOR'S WARRANTY IN RELATION TO THE FUNCTIONING OF THE SOFTWARE (INCLUDING A DONGLE, IF PROVIDED) ON ANY PARTICULAR SYSTEM ONLY APPLIES WHERE THE SYSTEM COMPLIES WITH THE LICENSOR'S HARDWARE AND SOFTWARE COMPATIBILITY LIST AS ISSUED FROM TIME TO TIME

TO THE EXTENT PERMITTED BY THE APPLICABLE LAW, AND SUBJECT TO CLAUSE 6 BELOW, THE LICENSOR DISCLAIMS ALL OTHER WARRANTIES WITH RESPECT TO THE SOFTWARE, EITHER EXPRESS OR IMPLIED, INCLUDING BUT NOT LIMITED TO ANY IMPLIED WARRANTIES OF MERCHANTABILITY OR FITNESS FOR ANY PARTICULAR PURPOSE.

THE LICENSEE ACKNOWLEDGES THAT THE SOFTWARE IS NOT DESIGNED FOR USE IN MISSION-OR SAFETY-CRITICAL SITUATIONS. THE ALGORITHMS UPON WHICH IT IS BASED INVOLVE STATISTICAL AND OTHER METHODS OF INTERPOLATION AND EXTRAPOLATION AND VISUAL OR OTHER OUTPUT WHICH IT MAY PRODUCE ARE THEREFORE LIABLE TO ARTEFACTS AND ERRORS INHERENT IN THE USE OF THESE TECHNIQUES. OUTPUT FROM THE SOFTWARE SHOULD ALWAYS BE CONFIRMED AND VERIFIED IN ACCORDANCE WITH RECOGNISED SCIENTIFIC AND EXPERIMENTAL PRACTICE. THE LICENSOR MAY BE PREPARED TO CREATE A SPECIALLY MODIFIED OR RE-WRITTEN VERSION OF THE SOFTWARE AT EXTRA

COST TO COMPLY WITH ANY SAFETY OR MISSION-CRITICAL REQUIREMENTS.

ALTHOUGH THE LICENSOR DOES NOT WARRANT THAT THE SOFTWARE SUPPLIED HEREUNDER SHALL BE FREE FROM ALL KNOWN VIRUSES IT HAS USED COMMERCIALY REASONABLE EFFORTS TO CHECK FOR THE MOST COMMONLY KNOWN VIRUSES PRIOR TO PACKAGING BUT THE LICENSEE IS SOLELY RESPONSIBLE FOR VIRUS SCANNING THE SOFTWARE.

THE LICENSOR WARRANTS THAT THERE ARE NO DISABLING PROGRAMS OR DEVICES IN THE SOFTWARE OTHER THAN THAT NECESSARY TO DETECT THE PRESENCE OF AN APPROPRIATE DONGLE (IF PROVIDED).

PROVIDED THAT ANY DONGLE PROVIDED HAS NOT BEEN MAL-TREATED THE LICENSOR UNDERTAKES THAT IN THE CASE OF THE FAILURE OF THE DONGLE IT WILL, AT ITS OPTION, AND AT ANY TIME DURING THE CURRENCY OF THIS LICENCE EITHER

- (i) replace the dongle; or
- (ii) replace the Software with a version of identical or enhanced functionality but which is not protected by the dongle device or is protected by an alternative dongle.

6. Licensor's Liability

- (a) The Licensor shall not be liable to the Licensee for any loss or damage whatsoever or howsoever caused arising directly or indirectly in connection with this Licence, the Software, its use or otherwise, except to the extent that such liability may not be lawfully excluded under the applicable law.

(b) Notwithstanding the generality of (a) above, the Licensor expressly excludes liability for indirect, special, incidental or consequential loss or damage which may arise in respect of the Software, its use, the System or in respect of other equipment or property, or for loss of profit, business, revenue, goodwill or anticipated savings.

(c) In the event that any exclusion contained in this Licence shall be held to be invalid for any reason and the Licensor becomes liable for loss or damage that may lawfully be limited, such liability shall be limited to the licence fee paid by the Licensee for the Software.

The Licensor does not exclude liability for death or personal injury to the extent only that the same arises as a result of the negligence of the Licensor, its employees, agents or authorised representatives.

Where the Software is to be used in any state of Australia and it is determined by a competent authority that the law of any such Australian state law apply to this licence, notwithstanding any other provisions contained herein, where any Act of Parliament implies any term into this Licence, and that Act avoids or prohibits provisions in a contract excluding or modifying such term, that term shall be deemed to be included in this Licence, but the Licensor's liability for breach of that term shall be limited in one or more of the ways (at the Licensor's option) permitted by section 68A(1) of the Trade Practices Act 1974 (Cth).

7. Copyright, Patents, Trade Marks and Other Intellectual Property Rights

The Licensee acknowledges that any and all of the copyright, trade marks, trade names, patents and other intellectual property rights subsisting in or used or in connection with the Software including all documentation

and manuals relating thereto are and remain the sole property of the Licensor and/or the Owner. The Licensee shall not during or at any time after the expiry or termination of this Licence in any way question or dispute the ownership by the Licensor and/or the Owner thereof.

8. Indemnity

(a) The Licensor agrees to indemnify and save harmless and defend at its own expense the Licensee from and against any and all claims of infringement of any patent, trade mark, industrial design, copyright or other proprietary right affecting the Software PROVIDED THAT (i) the Licensee shall not have done, permitted or suffered to be done anything which may have been or become an infringement of any such rights (including but not limited to using the Software to perform the Licensee's or other party's applications or using the Software in combination or merged with other software programs or devices) and (ii) the Licensee shall have exercised a reasonable standard of care in protecting the same; failing which, the Licensee shall indemnify the Licensor against all actions, proceedings, costs, claims and expenses incurred in respect thereof.

(b) The Licensee undertakes that the Licensor shall be given prompt notice of any claim specified in (a) above that is made against the Licensee and the Licensor shall have the right to defend any such claims and make settlements thereof at its own discretion and the Licensee shall give such assistance as the Licensor may reasonably require to settle or oppose any such claims.

- (c) In the event that any such infringement occurs or may occur, the Licensor may at its sole option and expense:
- (i) procure for the Licensee the right to continue using the Software or infringing part thereof; or
 - (ii) modify or amend the Software or infringing part thereof so that the same becomes non-infringing; or
 - (iii) replace the Software or infringing part thereof by other software of similar capability; or
 - (iv) repay to the Licensee the Licence Fee or balance thereof relating to the whole or the infringing part of the Software.
- (d) The Licensor's liability under this clause shall, at the Licensor's option, be limited to the Licence Fee less an equitable proportion thereof as relates to the period prior to cessation owing to infringement.

9. Confidential Information

- (a) All information, data, drawings, specifications, documentation, software listings, source or object code which the Licensor may have imparted and may from time to time impart to the Licensee relating to the Software (other than the ideas and principles which underlie the Software) is proprietary and confidential. The Licensee hereby agrees that it shall use the same solely in accordance with the provisions of this Licence and that it shall not at any time during or for a period of six years after expiry or termination of this Licence, disclose the same, whether directly or indirectly, to any third party without the Licensor's prior written consent.

16 Improvisation

- (b) Subject only to the specific, limited provisions of Clause 4(a) above, the Licensee further agrees that it shall not itself or through any subsidiary, agent or third party use such confidential information to copy, reproduce, translate, adapt, vary, modify, decompile, disassemble or reverse engineer the Software nor shall the Licensee lease, licence, sub-licence or otherwise deal with the Software (other than by sale as specifically referred to in sub-clause (d) below) or any part or parts or variations, modifications, copies, releases, versions or enhancements thereof or have any software or other program written or developed for itself based on any confidential information supplied to it by the Licensor.

The foregoing provisions shall not prevent the disclosure or use by the Licensee of any information which is or hereafter, through no fault of the Licensee, becomes public knowledge or to the extent permitted by law.

The Licensee shall be permitted to sell this licence PROVIDED THAT:

- (i) all copies of the Software held by the Licensee pursuant to this Licence shall either be destroyed or transferred to the Transferee on completion of the sale;
- (ii) the Licensee procures that the Transferee accepts the terms of the Licence;
- (iii) the Licensee gives notice to the Licensor of the transfer and the identity and address of the Transferee.

10. Force Majeure

The Licensor shall be under no liability to the Licensee in respect of anything which, apart from this provision, may constitute breach of this Licence arising by reason of force majeure.

11. Termination

- (a) In addition to provisions for termination as herein provided, the Licensor may by notice in writing to the Licensee terminate this Licence if the Licensee is in breach of any term, condition or provision of this Licence or required by the applicable law and fails to remedy such breach (if capable of remedy) within 30 days of having received written notice from the Licensor specifying such breach.
- (b) Upon termination, the Licensee shall pay to the Licensor all costs and expenses, including legal and other fees incurred and all arrears of fees, charges or other payments arising in respect of the Software, this Licence or otherwise and shall comply with its undertaking specified in Clause 4(g) above.
- (c) Termination, howsoever or whenever occasioned shall be subject to any rights and remedies the Licensor may have under this Licence or under the applicable law.

12. Assignment

The Licensee shall not assign or otherwise transfer all or any part of the Software or this Licence without the prior written consent of the Licensor or in accordance with the provisions of clause 9(d) above.

13. Waiver

Failure or neglect by either party to enforce at any time any of the provisions hereof shall not be construed nor shall be deemed to be a waiver of that party's rights hereunder nor in any way affect the validity of the whole or any part of this Licence nor prejudice that party's rights to take subsequent action.

14. Headings

The headings of the terms and conditions herein contained are inserted for convenience of reference only and are not intended to be part of or to affect the meaning or interpretation of any of the terms and conditions of this Licence.

15. Severability

In the event that any of these terms and conditions or provisions shall be determined by any competent authority to be invalid, unlawful or unenforceable to any extent, such term, condition or provision shall to that extent be severed from the remaining terms, conditions and provisions which shall continue to be valid to the fullest extent permitted by law.

16. Law

The parties hereby agree that the Licence concluded between them and constituted on these terms and conditions shall be construed in accordance with English law.

Contents

WHAT IS VOLOCITY?	27
Overview	27
About this Manual.....	28
Technical Support.....	28
INSTALLATION	29
Minimum System Requirements.....	29
Installing Volocity (Single License)	29
Installation for Server Systems	29
Starting Volocity for the First Time.....	30
Preferences	31
Session Log.....	35
Quitting Volocity.....	36
Upgrades from the Website.....	36
Automatic Check for Software Updates.....	36
Upgrading Applications on Client Machines for a License Server System	38
Activating Additional Products after Installation (Single License)	38
GETTING STARTED.....	39
Overview	39
Important Concepts	40
What is a Library?.....	41
Creating Libraries	41
Closing Windows and Libraries	45
Acquiring Data	45
Adding Data.....	45
Creating an Image Sequence.....	53
Creating Volumes	54

Importing Items (File Menu).....	55
ORGANIZING DATA IN A LIBRARY.....	59
Overview	59
Library Format	60
Library View.....	60
Library Menu.....	60
Library Thumbnails and Icons.....	62
Setting Item Properties (Edit menu).....	63
Creating New Folders.....	64
Copying and Moving Folders and Items	64
Finding Items (Edit menu)	65
Delete/Remove Items from a Library	66
Locating an Item (Actions menu)	67
Compacting Libraries.....	67
VIEWS ON DATA.....	69
Overview	69
Library View.....	70
How Do I Look at Items in the Library?.....	71
Image View.....	73
Image Sequence View.....	104
Voxel Spy	111
Gallery View	113
Show in Library.....	113
Notes View	113
Capture Snapshot Command (View-Specific menu)	113
Show Data Library menu	114
Sort Items Library menu	114
MANIPULATING DATA	116
Overview	116
Undoing Commands.....	117

Batch Processing.....	117
Adopting Items (Actions menu).....	117
Applying Auto Contrast (Tools menu).....	117
Changing Color Depth (Tools menu).....	119
Changing Colors (Tools menu).....	120
Changing Size (Tools menu).....	121
Cloaking Items (Actions menu).....	122
Color Balance (Tools menu) (Not Available in Volocity LE).....	122
Contrast Enhancement (Tools menu) (Not available in Volocity LE).....	123
Background Corrections.....	125
Creating Background Corrections (Actions Menu).....	126
Inspecting Background Corrections.....	129
Correcting Background (Tools menu).....	129
Creating Registration Corrections (Actions menu).....	131
Correcting Registration (Tools menu).....	134
Correcting Photobleaching (Tools menu).....	136
Cropping Items (Actions menu).....	137
Illumination Correction (Tools menu).....	138
Merge Planes (Actions Menu).....	138
Removing Noise (Tools menu).....	139
Splitting Multi-Colored Items (Actions menu).....	140
Splitting Volumes (Tools menu).....	140
Splice Sequences (Actions menu).....	141
Tile Sequences (Actions menu).....	141
PRINTING AND EXPORTING DATA.....	142
Overview.....	142
Printing from the Application (File menu).....	142
Exporting Items (File menu).....	142
VOLOCITY ACQUISITION INSTALLATION AND REFERENCE.....	149
Overview.....	149
Installing and Configuring Devices.....	150

Setting Preferences	150
Device Controls	154
Calibrating Objective Lenses	161
Measuring Device Latencies.....	163
Light Paths.....	164
The Video Preview Window.....	168
Video Feedback Panel	172
Acquisition Setup Dialog.....	173
Capturing Image Sequences	189
Acquisition Feedback	191
Events and Logs.....	192
PerkinElmer Ultra <i>VIEW</i> [®]	194
Configuring the Ultra <i>VIEW</i> in Preferences	195
Ultra <i>VIEW</i> Controls	197
Preparing to Use the Ultra <i>VIEW</i> in Volocity.....	199
PhotoKinesis™ Accessory	200
Calibrating the PhotoKinesis Accessory	202
XY Stage, Multi-Point Acquisition Process	206
FRAP Acquisition.....	223
3D Targeted Illumination Experiments.....	230
FLIP Acquisition.....	231
Ratio Acquisition.....	233
Spectral Separation	241
Live Fast Restoration.....	253
OptiGrid [®]	255
Connecting the OptiGrid [®]	255
Calibrating the OptiGrid [®]	262
Using the OptiGrid [®]	268
Troubleshooting Grid Imaging	278
Installing and Configuring Photonics Instruments MicroPoint [®]	280
Calibrating Photonics Instruments MicroPoint [®]	281

VOLOCITY ACQUISITION WORKED EXAMPLES.....	285
Overview	285
Example Acquisition Protocols	286
VOLOCITY VISUALIZATION.....	301
Overview	301
3D in the Image View	302
3D Modes in Image View.....	303
3D Opacity.....	305
3D Ray Tracer	312
3D Slice	316
Image Menu.....	323
Image Toolbar	325
Setting the Pivotal Point of Rotation	326
Free Flight Camera Control	326
3D Image Bookmarks	328
3D Image Movie Interface	330
Creating QuickTime VR Movies.....	337
Aligning Volumes.....	339
VOLOCITY QUANTITATION WORKED EXAMPLES	340
Overview	340
Measuring a Single Timepoint	341
Measuring Multiple Timepoints.....	345
Measuring Multiple Image Sequences.....	354
Measuring and Tracking Multiple Timepoints	361
Colocalization	371
VOLOCITY QUANTITATION REFERENCE	376
Overview	376
Measurements View	377
Using the Drawing Tools	378
Kymograph	387

Object Feedback	389
Measurements Table or Histogram	394
Creating Measurement Protocols	396
Measurement Protocol Tasks	397
Clear, Save, Restore and Export Protocol	425
Batch Processing Measurements	427
Measurement Items	428
Raw Data View	429
Feedback Options Dialog	436
Change Object Colors	437
If Feedback is not Displayed	438
Measurement Definitions	439
Analysis View	445
Analysis Examples	449
Chart View	463
Colocalization	467
FRAP Analysis	479
FRAP Measurement Item	486
Ratio Analysis	489
FRET Analysis	493
Intensity Modulated Images	499
VOLOCITY RESTORATION	501
Overview	501
Calculate PSF	503
Measure PSF	505
Applying Fast Restoration	506
Applying Iterative Restoration	509
Illumination Correction	512
GLOSSARY	513
APPENDICES	517

Sampling Widefield Data for Deconvolution517
What Causes Axial Elongation of Structures in Optical Microscopy?521
OptiGrid® Structured Light Algorithm522
INDEX 524

What is Volocity?

Overview

Volocity is an innovative, high performance 3D imaging software product designed specifically for Life Science research. It allows the scientist to visualize, explore and analyze multi-channel 3D volumes over time, providing information that is difficult to obtain in any other way.

Volocity can be used for 2D imaging as well as 3D and 4D imaging and will accept image sequences from confocal and wide field microscopes. The software consists of a core product and four unique, totally integrated extension products that provide a full suite of tools for 3D image acquisition, volume visualization, restoration, publication, and object classification, tracking and charting.

The Volocity products can be purchased individually or in combination, according to requirements. In addition, a reduced version of the core, Volocity LE, is available to download free of charge from the Improvise website.

Volocity Acquisition

Volocity Acquisition is designed specifically for high performance acquisition of time-resolved, multi-channel 3D sequences. It supports a range of hardware suitable for 3D imaging, including wide field microscopes, scientific grade digital cameras, fast focus drives and wavelength changers.

Volocity Quantitation

Volocity Quantitation is designed to identify, measure and track biological structures in 2D, 3D and 4D. This unique module incorporates innovative classification technology for rapid identification and quantitation of populations of objects in 2D, 3D and 4D.

Volocity Restoration

Volocity Restoration includes restoration algorithms and measured or calculated PSF generation options for confocal and wide field microscopes. The Volocity restoration algorithms are designed for rapid, high-quality restoration of 4D and 3D volumes and for accurate comparison and quantitation of time-resolved changes.

Volocity Visualization

Volocity Visualization provides an extensive range of visualization and publication features. The Volocity 3D View enables the user to interactively explore a 3D rendered object. The user can, in real time, rotate, zoom and animate the 3D object whilst simultaneously varying the contribution and rendering mode for each channel. The user can also position the viewing point either outside or inside the 3D object, and then watch as structures change and develop over time. Bookmarks may

About this Manual

be used to store the position and appearance of the 3D volume and the movie interface may be used to animate transitions between bookmarks.

About this Manual

This manual describes all the features of Volocity. The initial chapters describe the features that are available to all users. Each product then has its own chapter, so that the reader can easily locate relevant information. The manual is designed for users of both Mac and WINDOWS versions of Volocity. The screenshot examples show the Mac interface. The screenshots often assume that all features are enabled. If you do not have access to a command, it may belong to a product not licensed on your system.

Technical Support

If you have any queries about installing and using Volocity, contact Improvion Support:

USA:

E-mail: support@improvision.com

Telephone: +1 (866) 310 0932

Europe and Rest of World:

E-mail: support@improvision.com

Telephone: +44 (0) 24 7669 8121

Web Page

You can also get additional information about Improvion and its products from the web page:

<http://www.improvision.com/support>

Information to Provide

When contacting Technical Support please be prepared to provide information about your system including the dongle or serial number.

You may be asked to provide information about your computer hardware and from the Volocity system Session Log, see page 35.

Installation

Minimum System Requirements

The computer hardware market changes rapidly and, as a result, information about minimum and recommended system requirements also changes. Please refer to the technical notes published on the Support area of the Improvion web site, <http://www.improvion.com>, for the up-to-date specifications.

Volocity is available for Windows and Mac. The exact specification for your computer depends on the type of Volocity configuration that you intend to run. If you are running Volocity extension products you will require a much higher specification than if you are using Volocity LE. Similarly, if you are working with large volumes you will require a fast, powerful processor and the maximum possible capacity of RAM for the machine.

Please note: Volocity 2.5 was the last version of the software to include support for the following operating systems: Mac OS 9, Windows 98, Windows NT4 and Windows ME.

Note: A Volocity dongle will work with both Volocity for Macintosh and Volocity for Windows.

Installing Volocity (Single License)

To install Volocity LE you require an unlock code and a serial number. You obtain these when you download Volocity LE from the website. This is all you need to install the software.

To use any of the chargeable products you must purchase a dongle, which is a security device that will be registered for your required package. It must be plugged into an unused USB port. Software for the full version of Volocity with chargeable products is also available on CD-ROM. Additional functionality can be added later using a serial number provided when you purchase the product. Please ensure that you read the accompanying license before installing the product.

Follow the instructions supplied with the web download or CD-ROM to install Volocity.

Installation for Server Systems

If you are using the Improvion License Server (ILS), you will first need to install and configure the license server application on a machine with a static IP address that all client machines will be able to access. See the "*License Server User Guide*" for complete instructions on how to do this.

Install Volocity on machines that will access the License Server as described in "Installing Volocity (Single License)". These client machines will not need their own dongle, they will obtain Volocity licenses by connecting to the license server.

Starting Volocity for the First Time

- n Volocity LE requires a serial number and unlock code which you may obtain by registering on the Improvion website.
- n If your license is on a dongle, ensure that the dongle is plugged in and the light inside the dongle is illuminated. This indicates that the dongle drivers are correctly installed.
- n If your license will be obtained from the license server, make sure that you know the license server IP address and port number. You will also need a user ID and, possibly, a password for the license server. This is normally set up by the person who installs and manages the license server.

1. Start Volocity.

On the Mac: Volocity is installed in the Applications folder. Start by double clicking on the icon.

On Windows: Volocity can be found by navigating through **All Programs** in the start menu.

2. If you have a dongle installed you should see no further messages, Volocity will run. If a licensing message does appear, make sure the dongle is plugged in and click **Retry**.

To use a license server click **Server...** at the dialog shown and enter the details of the Improvion License Server for which you have a user ID and password.

To use Volocity LE click **Unlock...** at the dialog shown and enter the serial number and unlock code.

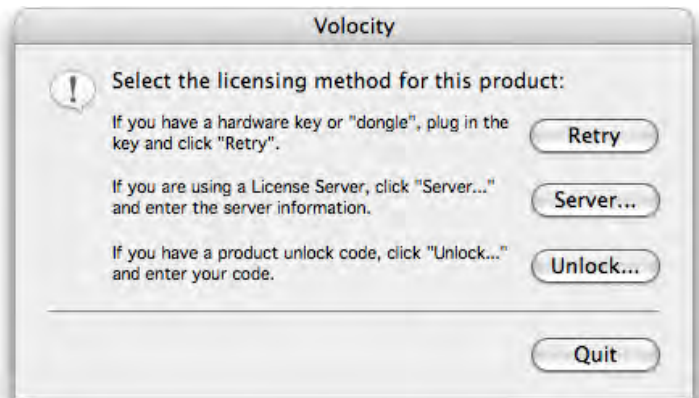

Changing Your License Server Password

1. When the **Connect To Server** dialog is shown click on the **Change Password...** button.



2. Enter the new password twice to confirm it and click **OK**.

You may also be required to change passwords, when a dialog to that effect is shown. This may be to change a default password or at the request of the Improvisation License Server administrator.

Switching from a License Server to Individual Licenses

Volocity LE: Start up Volocity whilst holding down the 'Apple' key (Mac OS) or the 'R' key (Windows) to bring up the License dialog. Click **Unlock...** to enter the serial number and registration code for your individual license.

Volocity: Plug a Volocity dongle (not an Improvisation License Server dongle) into a free USB port on the machine. Start Volocity. Volocity will recognize the presence of the dongle.

Switching from Individual Licenses to a License Server

Volocity LE: Start up Volocity whilst holding down the 'Apple' key (Mac OS) or the 'R' key (Windows) to bring up the License dialog. Click **Server...** and enter the server IP address and port number.

Volocity: Remove the Volocity dongle from the USB port that it is connected to. Start up Volocity. You will be shown the license dialog. Click **Server...** and enter the server IP address and port number.

Preferences

The Preferences dialog allows you to customize various settings.

1. Mac OS X users select **Preferences...** from the Volocity menu. All other users select **Preferences...** from the Edit menu.
2. Select the required preference by clicking on the icon in the left-hand pane.

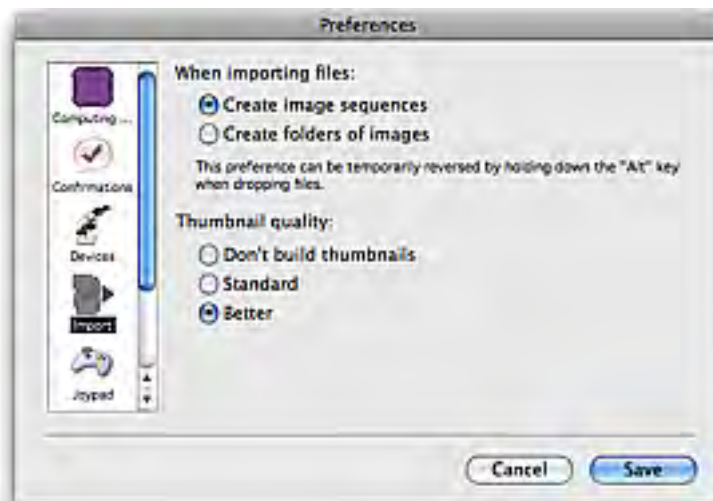

3. Make the required changes and click on **Save** (Mac) or **OK** (WINDOWS).

The **Import** preferences allow you to define how images will be imported and to either switch thumbnails off or select the quality (Standard or Better).

The **Confirmations** preferences include settings for displaying hints and checking for software updates. Click on **Reset Hints** if you want the hints to be displayed. Click on **Automatically check for software updates** to ensure that you are informed when new software is available from Improvion.

Other preferences are only applicable if you are running particular products and are described in those chapters.

Imaging Computing Server

The Imaging Computing Server (ICS) is a software utility that distributes parts of a task between multiple, similar processing units to accelerate processor intensive operations.

The ICS currently accelerates the following Volocity tasks:

- n Restoration
- n Ray tracing
- n Noise removal
- n 4D measurements (excluding tracking)

See the separate ICS guide for more details about specifying and configuring hardware for the ICS.

To configure Volocity to use the ICS:

4. Start Volocity. Select **Preferences...** from the Edit menu (Windows) or the Volocity menu (Mac OS). In the Preferences dialog select Servers.



5. Click + to add a server. In the Add Server Dialog select Imaging Computing Server as the type.



6. Enter the details of the server and an appropriate user name and password for that server. You may need to ask the administrator of the ICS for this information.
7. Click **Options...** to configure behavior of this computer with the ICS.



Use the Imaging Computing Server will mean all operations that can be accelerated by the ICS will be sent to the ICS. This computer will not share the processing.

Use the Imaging Computing Server and this computer will mean this computer is recruited as an additional node for processing operations that can be accelerated by the ICS. Select this option only if this computer is of comparable or higher specification to the node computers. A lower specification computer will act as a bottleneck in the processing and slow the overall process down. A comparable specification computer will increase the speed of processing. If there are already jobs queued on the ICS progress will still be made on the local computer. This computer will only be used as a node for processes started on this computer.

Process all operations on this computer will mean the ICS is not used.

Every process that can be accelerated by the ICS will require the data to be broken down into jobs. The way the data is broken down i.e. the definition of a job varies depending on the supported operation.

Iterative Restoration

1 job = 1 volume (1 channel, 1 timepoint)

Or

1 job = 1 block if **Break image into blocks** is enabled in the restoration dialog.

Block size is calculated using RAM /processor, determined using the total amount of RAM in all nodes divided by the total number of processors in all nodes.

Remove Noise

Data is divided up by timepoints, channels and volumes calculated to utilize all processors equally. Exact division will vary with data set.

Measurements

1 job = 1 timepoint

If tracking is included in a measurements protocol detecting and measuring objects in individual timepoints will be distributed between the nodes but the tracking step, measuring over all timepoints, will be sent to just one of the nodes.

Ray Trace

At the start of ray tracing a copy of the entire data set is sent to each node, the client copy of Volocity requests each tile of the scene as it builds it.

Session Log

The Session Log records information from when Volocity is started up until it is quit. Session logs always display:

- n The version of Volocity that is being run
- n The build date of that version which will be on or before the SMA expiry date for the license
- n The serial number for that product
- n Information about the computer hardware on which Volocity is running
- n Any products that are loaded
- n Any error messages

Session logs provide valuable information to Improvisation Technical Support engineers when diagnosing hardware or software problems.

Show the Session Log by selecting **Show Session Log** from the Window menu.

Session logs may be saved by clicking on the save button or emailed directly from the Session Log window.

Quitting Volocity

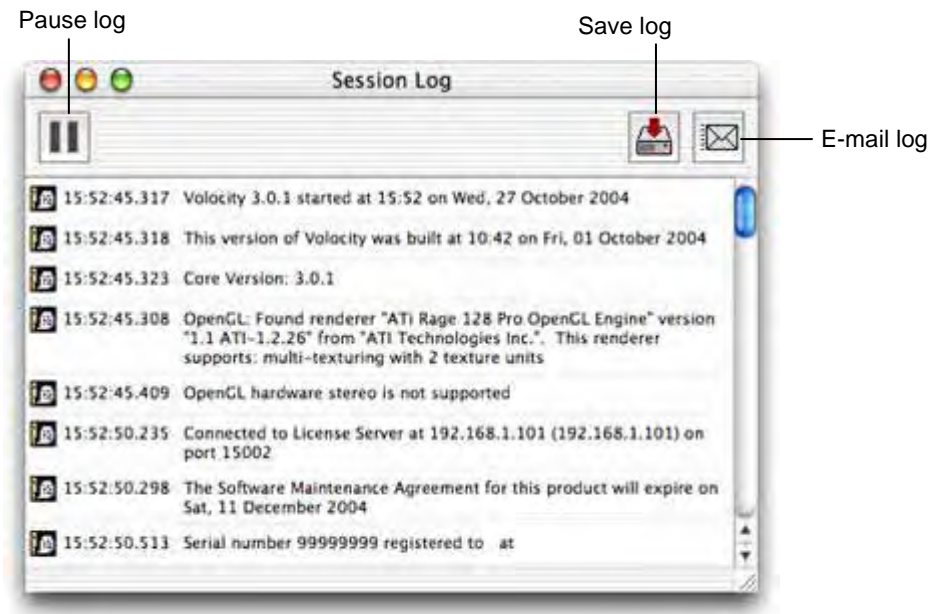

Quitting Volocity

Select **Quit Volocity** from the Volocity menu (Mac) or **Exit** from the File menu (WINDOWS). Volocity automatically saves all changes to a library before it quits.

Upgrades from the Website

For Mac OS or Windows simply download the latest installer from the Improviation website and double click to start the installation process. To perform installations you will need an administrator user name and password for the computer. Follow the instructions on screen and restart your computer when requested.

Automatic Check for Software Updates

Alternatively, use the Preferences dialog to enable automatic checking for software updates. Select **Confirmations** and check the box next to **Automatically check for software updates**.

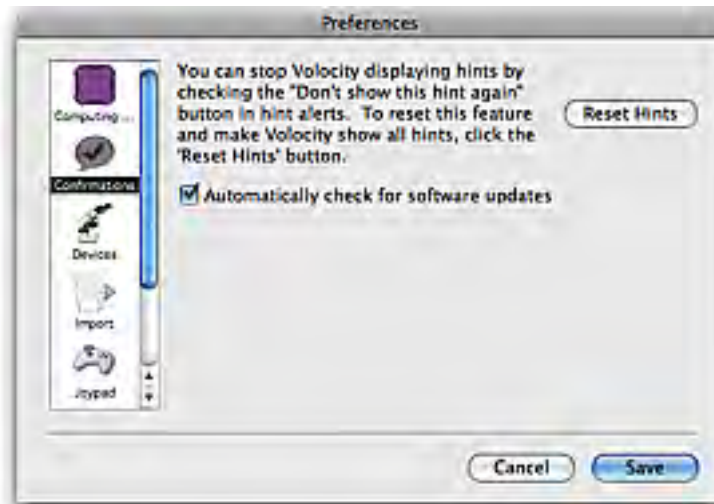

The Improvion server is checked for a newer version on start up. In order to query the Improvion server, the machine running the software must be connected to the Internet. When a later version is detected a message similar to the following is displayed:



Click **Download** and download the installer for the application you wish to upgrade. Run the installer and follow the instructions on screen.

Note: During the upgrade process, the installer will check that you have a valid Software Maintenance Agreement. No information is sent to Improvion during this check, but the upgrade will fail if you do not have one.

Upgrading Applications on Client Machines for a License Server System

Upgrading an application served by the Improvisation License Server is simple. All the information relating to users, groups and configurations is stored on the server so there is no special process for installation. See the instructions for Upgrades from the Website on page 36.

Activating Additional Products after Installation (Single License)

Note: This section is not relevant if your organization has a network license. Refer to the separate "Improvisation License Server User Guide" for instructions on adding licenses to a server.

If you purchase additional products to add to your original installation, you will receive an unlock code which you must enter in the Unlock Codes dialog. You can do this at any time after installing the software, as long as you have a valid dongle attached to your computer.

Note: If you are upgrading from Volocity LE, you will need to purchase a dongle. When you attach the dongle and run Volocity, the purchased extension modules are automatically enabled.

1. Mac OS X users: Select **Unlock Codes...** from the Volocity menu.
Windows users: Select **Unlock Codes...** from the Help menu.
2. You now need to enter a **Code** for each additional product that you have purchased.



3. Enter the **Code** for the first product and click on **Unlock**. There is no need to specify which product is being added and you can enter codes for products in any order.
4. Repeat step 3 for each product that you have purchased.
5. Quit and restart the software so that the unlock code can take effect.

Getting Started

Overview

This chapter describes:

- n important concepts
- n what a library is
- n how to create libraries
- n how to open existing libraries
- n how to close libraries and windows
- n how to acquire and add images to a library
- n how to create an image sequence
- n how to create volumes
- n how to import items
- n supported file formats

Important Concepts

- n Data is kept and organized in libraries. A library may contain many experiments and associated information. See page 41.
- n Libraries are files which are created using the **New** option in the file menu. Existing libraries are opened using **Open** from the File menu.
- n Libraries are databases, changes to databases are saved as they are made, there is no Save command.
- n Image sequences organize images that represent channels, time and/or z slices. See page 53.
- n Data imported into Volocity have properties. Properties record information about the experiment that acquired the information and affect how items are visualized or processed elsewhere in the software. Properties may be searched for.
- n Image data is explored in different ways using views. When an item is opened in the library the views are shown in tabs along the top of the window. See page 69.
- n Toolbars update when views change to show the appropriate tools. Tooltips, shown when the cursor is moved over a tool, indicate the purpose of that tool.
- n View-specific menus with the same name as the view configure the appearance of the view and access processing specific to that view. For example, when working with the Image View the menu bar will show an Image menu.
- n Many menu commands have shortcut keys. If you look at the command in the menu, you will see any shortcut keys to the right of the command name. WINDOWS users can use the standard Windows shortcut; right click on the mouse, to display a list of valid menu commands.
- n Menu items open dialogs allowing data processing and image enhancement. Dialogs support batch processing of many data sets with one command. See page 117.
- n Choose to apply a process to items from a group by selecting them, this highlights them in the interface.

What is a Library?

A library is the term given to the data storage format used by Volocity. A library must be created and images added to it before they can be viewed in Volocity. A library must be opened for Volocity to acquire data.

Libraries are based on a database structure and will store changes as they are made.

Creating Libraries

1. You can select **Create a new library** from the prompt shown when Volocity starts (unless you have disabled it).

Or, once you are running the application, select **New Library...** from the File menu. (You can only have one library open at a time. If you already have a library open, you will be prompted to close it first.)

2. Use the dialog to name the library and choose a location to store it.

Creating Libraries

On the Mac, a dialog similar to the following is displayed. Enter a **Name** for the library. The library format is called **Multi-file (version 2)** with the extension **.mvd2**. Click on **Save**.

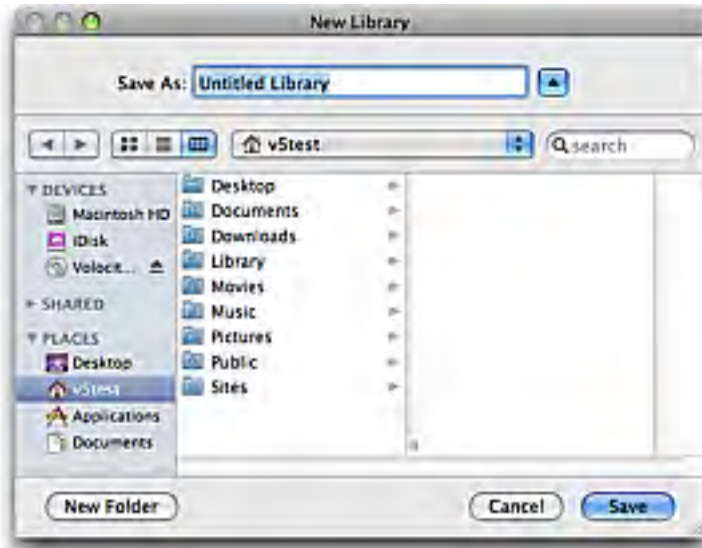

On Windows, a dialog similar to the following is displayed. Enter a **File name** for the library.

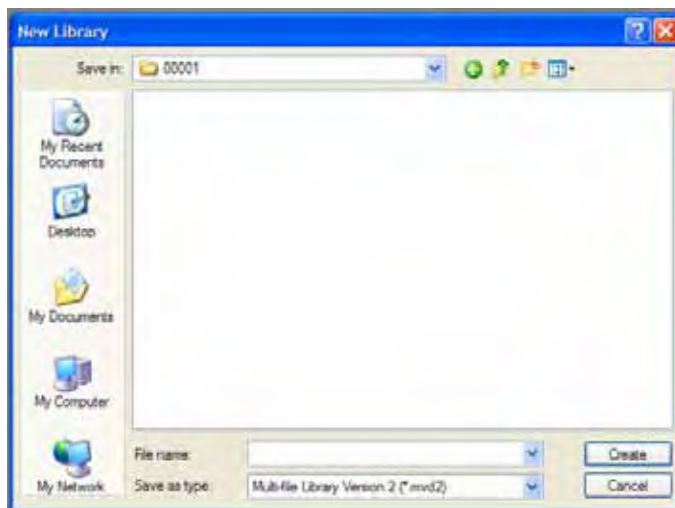

3. A library window is displayed. You are now ready to add items to the library.

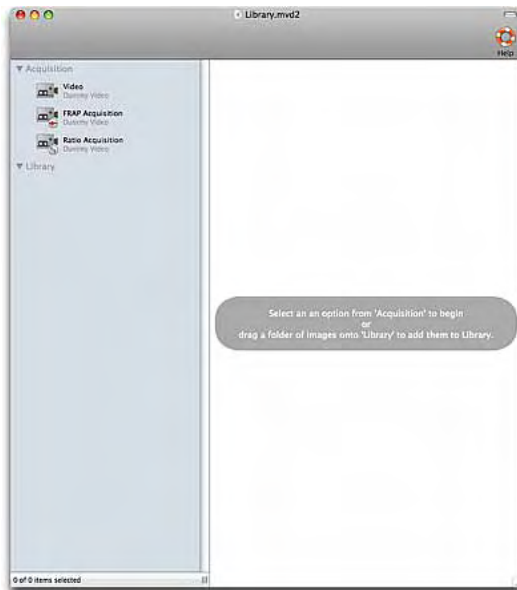

Library Format

The application creates libraries in a multi-file format, which handles large data sets well and gives fast data access. When you create a multi-file library, it is created within a folder. This folder is labeled with an icon and the name of the library.

Inside the folder are the library file and a data folder, which contains all the data required to view the images and volumes kept in that library. Multi-file library files have the suffix `.mvd2`.

Mac OS X

A Volocity library appears in the Finder like this, with its name below it.



Opening this folder will reveal the `.mvd2` file and the data folder.

Creating Libraries



Windows

A Volocity library appears in Explorer like this



Opening this folder reveals the .mvd2 file and the data folder.

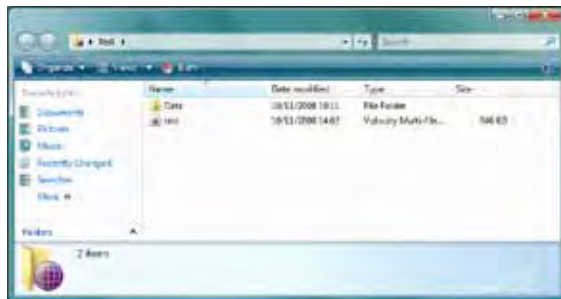

It is essential that the library file and data folder are kept together, which is why the application creates them together in a separate folder.

The .mvd2 file describes how the data is to be read by Volocity. The data folder contains many files none of which can be read by any application.

To open the library, you must first open this folder and locate the library file. If you want to move a multi-file library to another location you must move the whole folder. If you only move the library file, the application will not be able to display any of its contents.

Opening Libraries

Once you have created a library, you can either double click on the library icon to open it, or select **Open Library...** from the File menu and choose the required library in the dialog. All libraries must have a .mvd2 extension or they will not be visible in the file list.

Only one library may be open at a time. If you already have a library open, the application will prompt you to close it. Once the Library window is displayed, you can add new files to it, as described on page 45.

Closing Windows and Libraries

The application conforms to the standard Mac and Windows conventions for closing windows.

On a Mac, close the current window by selecting **Close** from the File menu. If the current window is the Library window, this command closes the library. You can also close any window by clicking on the top left-hand corner of the window.

On Windows, close the library by selecting **Close Library...** from the File menu. Close the current window(s) by selecting **Close** (or **Close All**) from the Window menu. You can also close any window by clicking on the top right-hand corner of the window.

Acquiring Data

Data may be acquired during experiments using hardware for acquisition, that is, cameras and devices for microscope automation. All hardware must be installed and configured before use. This is described in full detail in “Volocity Acquisition Installation and Reference” starting on page 149. This chapter describes how to:

- n Install and configure devices
- n Use the Video preview to work with devices
- n In the Video Preview use light paths to coordinate changes to devices to meet the requirements of imaging modes

Once light paths have been configured they may be used in acquisition protocols. Acquisition protocols allow different combinations of channels, focus movement and XY control to be used in experiments that capture data.

Example Acquisition Protocols for a variety of different experiments are described in the section starting on page 173.

Adding Data

Libraries can contain 2D and 3D images, which may be viewed in a number of different ways. The way that you add items to the library depends upon the type of images and how you want to view and work with them.

- n Acquisition from a camera adds images directly to image sequences. Image sequences are used to work with time and/or channels
- n You can also drag and drop folders of images into an open Library window to add them to the library

- n If you are adding a series of slices from one object at one timepoint on one channel, import the data as a folder of images and then create a volume as described in "Creating volumes." on page 54. For example, you may be creating a volume of data from which to measure a PSF (Volocity Restoration only)

Note: You can also use the **Import** command from the File menu to add single, unrelated items.

Adding Images Using Drag and Drop

The easiest way of adding items to the library is to drag an item from the desktop and drop it onto the Library window.

For ease of use when image sequences are required set the **Import** preference to create image sequences rather than create folders of images. To do this, select **Preferences...** from the Edit menu (Windows) or the Volocity menu (Mac OS).

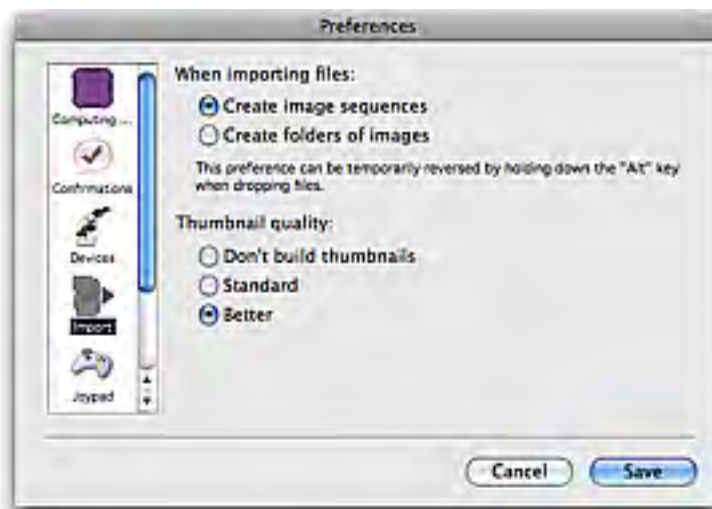

In the following drag and drop example, an image sequence is created.

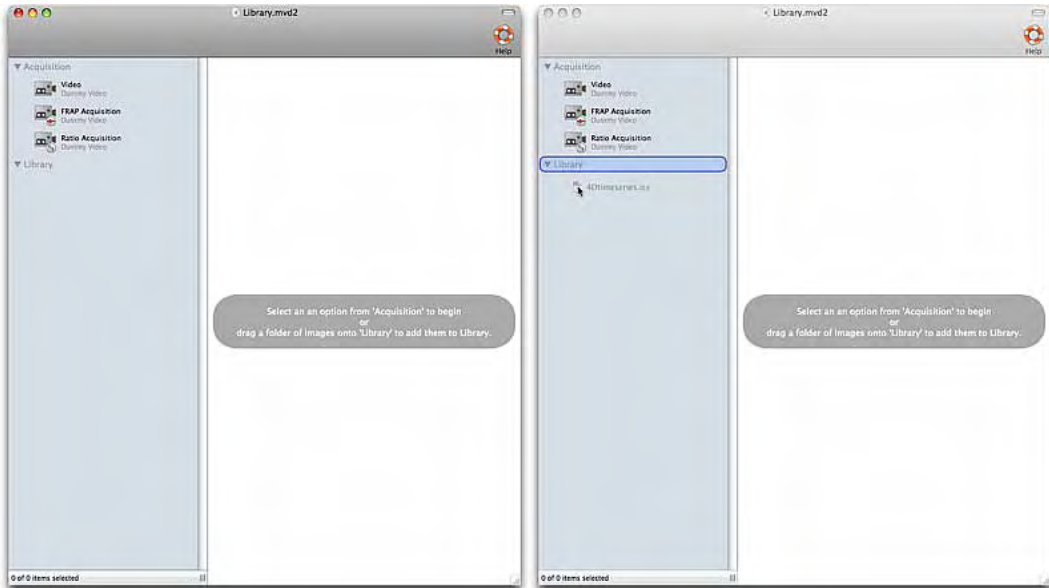

Click once on the item to select it in the library. Available views on that data will be shown on the right hand side. Double click to open the item in its own window. For more information about views on data see page 69.

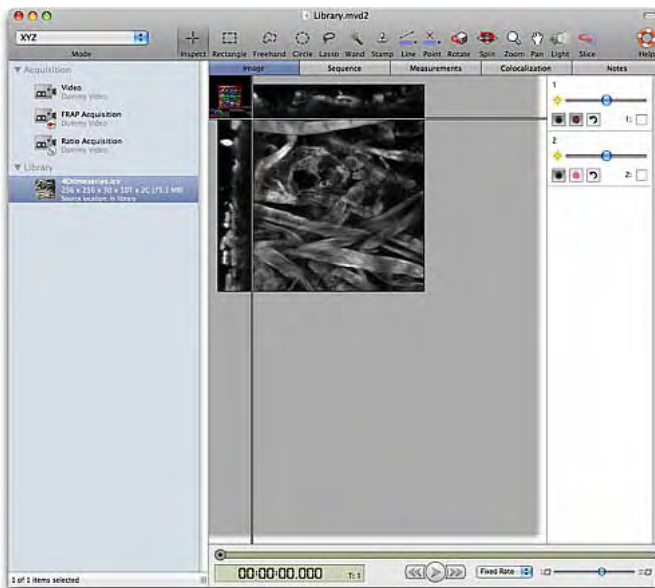

Drag and drop multiple folders or files to create multiple image sequences.

If the item dragged is a folder, such as a series of slices for a volume, the application will scan the contents of the folder and add all the files it recognizes to the library. Any hierarchy within the item that you drag and drop onto the Library window is retained.

You can continue to drag as many folders or files as required onto the library, and you can add items to any level of folder structure. The insertion is indicated by the creation of a space in the library or the highlighting of the folder to which the item will be added. The amount of indentation indicates the level at which an item is located within the library hierarchy.

If image data is recognized but metadata about timepoints, channels and slices per stack is absent or not supported Volocity will add the images in a folder. These images may not have transferred spatial calibration information, channel names or timestamps. You will need to create an image sequence and add these files to it, specifying the image organization and entering calibration information in the image sequence properties dialog.

Note: The only limit on library size is the hard disk space. However, it is usually more practical to separate work into more manageable sets and create separate libraries for each one.

If you are adding a series of slices from one object at one time point in one channel, import the data as a folder of images and then create a volume. For example creating a volume of data from which to measure a PSF (Volocity restoration only).

Note: You can also use the Import command from the File menu to add single, unrelated items.

Working with a Columbus™ Server

Columbus™ is a convenient and easy-to-use solution for high volume data management, storage, retrieval, visualization and protection of images and analyzed results. Columbus can import, export and manage image formats from a wide variety of sources, providing a central repository and solution for all your microscope imaging requirements.

For more information on the Columbus range of products from PerkinElmer see:

<http://las.perkinelmer.com/Imaging/Products/HCS/Columbus.htm>

Volocity interfaces with a Columbus server allowing download of files from the server and uploading of files from Volocity to the server. Currently only 16 bit files up to a maximum of 150 MB may be added to a Columbus server from Volocity. Additional annotation information is not transferred from Columbus to Volocity when downloading files.

Connecting to a Columbus Server

Start Volocity. Select **Preferences...** from the Edit menu (Windows) or the Volocity menu (Mac OS). In the Preferences dialog select Servers.



Click + to define a server. In the Add Server dialog select Columbus Server as the type.



Enter the details of the server and an appropriate user name and password for that server. You may need to ask the administrator of the Columbus Server or your network for this information.

Click **OK** to save these settings.

Adding Data

Multiple Columbus servers may be connect to from one Volocity client. Add additional servers as required.

When these preferences are saved the Columbus server will be available as an option in the library view.

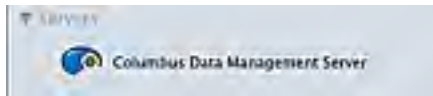

Click once on the server to open a view of the server data on the right hand side of the Library view.

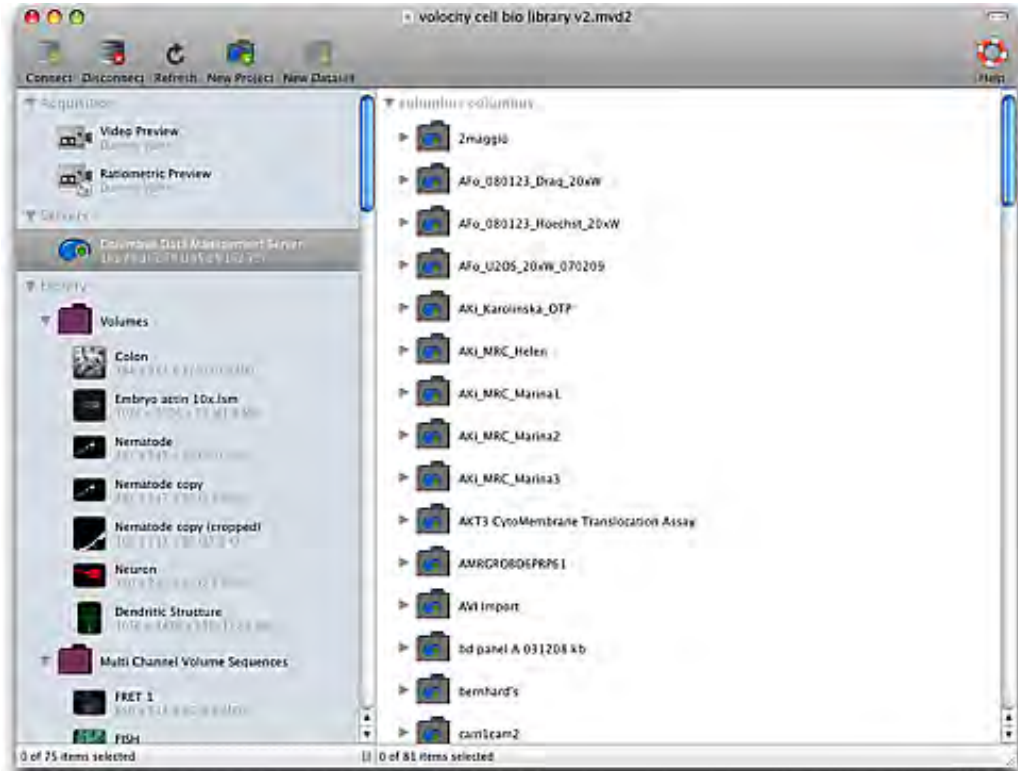

Double click the server name to open the Columbus view in a separate window.

Data are added to a Volocity library from the Columbus server by dragging from the Columbus view and dropping into the Library view.



A space is created to show where the item will be added.

Data may also be dragged from the Columbus server to the desktop of the machine.

Data are added to the Columbus server from the Volocity library by dragging from the Library view into the Columbus view. Files can only be added to the Columbus server if they follow the convention of Projects and Datasets imposed by the Columbus server.

Adding Data

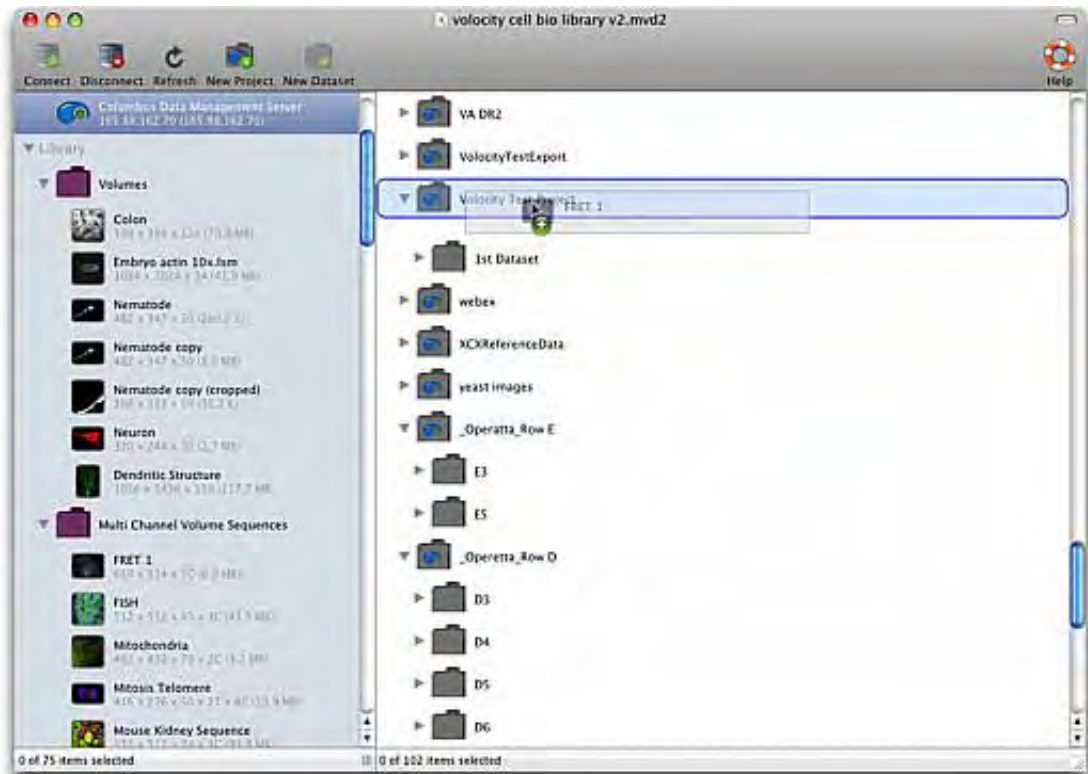

An image or image sequence can only be added to a Dataset. A new Dataset may be created within an existing Project by selecting the Project and clicking New Dataset in the tool bar. A new Project may be created using the New Project button. Drag the image(s) over the Dataset folder until it is highlighted

A folder of images or image sequences may be added to a Project by dragging the folder from the library onto the Project.

Creating an Image Sequence

An image sequence is a collection of images arranged by channel and timepoint. Multi-channel and/or time-resolved data with one or more planes in z is best viewed using an image sequence.

Set the **Import** preference to **Create image sequences** to automatically make image sequences when importing related data.

The Image Sequencer is a powerful tool for working with data related by time and/or channel. Once you have created an image sequence, you will be able to interact with the data in a number of different ways. See page 104.

There are rules about the type of data that may be made into an image sequence:

- n All images in a channel must have the same depth and color look-up table
- n The images must make up volumes that have identical X, Y and Z dimensions

To Create an Image Sequence Item:

1. Select **Create New** from the Actions menu.
2. Select **Image Sequence** to create a new image sequence item in the library.
3. The Image Sequence is selected in the library automatically.

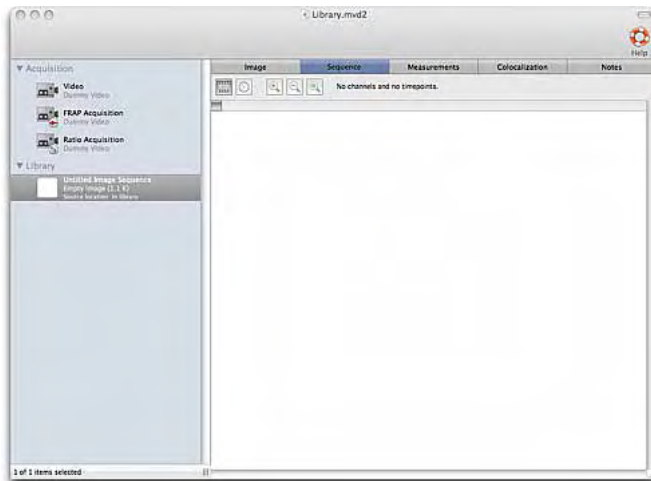

4. Drag and drop all the data for an experiment into the open Image Sequence view. The dialog allows you to specify the order that the images are in and therefore how they should be arranged in the final sequence.

Creating Volumes

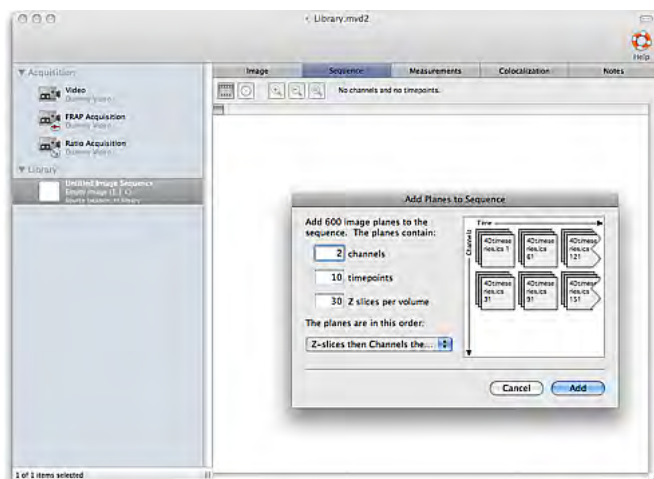

Tabs in this window allow you to display different views of the data. You use the Image Sequence tab to add items to the sequence; it provides an overview of each channel and timepoint.

Hold the cursor over an item in the Image Sequence view to show a tip that gives the timestamp, channel and type.

Creating Volumes

A volume is the name for a 3-dimensional object within Volocity, it is made up of a stack of images.

If you are working with images from a single object at one timepoint or one channel, use the **Make Volumes** command to create a volume. For example, once you have added an image sequence that contains 2D images related in the Z-dimension, such as confocal microscope, wide field microscope or magnetic resonance image stacks, you can use this command to create a volume within Volocity.

Note: If you are working with multi-channel or time-resolved data, the easiest way of doing this is to use the Image Sequencer see page 53.

1. Select the item(s) in the library. From any folder or file containing many images you can select individual images; for example, all the images belonging to a channel.
2. Select **Make Volumes** from the Tools menu.
3. The Windows version of the software always gives you the option of scaling down the source images in the volume.

Mac users should hold down the Alt key when selecting **Make Volumes**, if they want to apply scaling.



4. Enter scaling values as a percentage and click on **Create**. Volocity creates the volume and the Library view now contains an image item for the 3D data.

Importing Items (File Menu)

To add single files to a library you can use the Import command.

1. Select **Import...** from the File menu to display a dialog similar to the following.

The import dialog in Mac OS X:

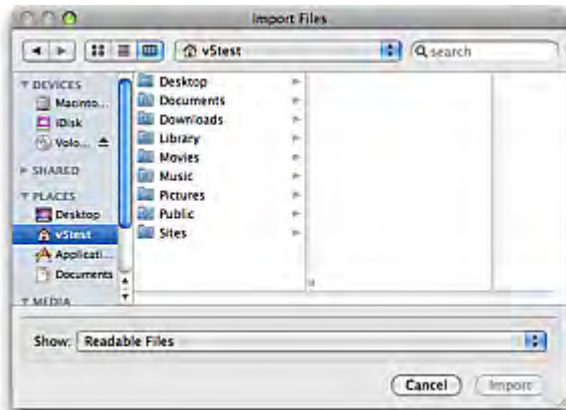

Importing Items (File Menu)

The import dialog in Windows Vista:

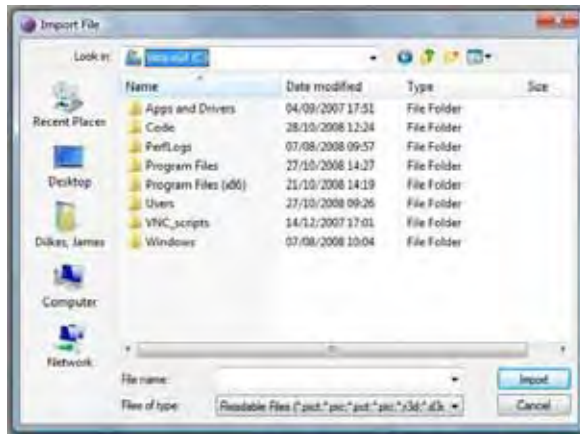

2. Locate the required image. If it is in a folder, select the folder and click on **Open** to open it. Once you have located and selected the image, click on **Import** to add it to the library.

Supported File Formats

For reading, Volocity currently supports the following formats:

- n BioRad PIC
- n Windows BMP
- n Volocity Library Clipping
- n DeltaVision
- n ICS/IDS (Image Cytometry Format)
- n JPEG
- n Leica LIF (generated by Leica confocals)
- n NeuroLucida Tracing XML format
- n Openlab LIFF
- n PerkinElmer AIC
- n Apple PICT
- n QuickTime Images (this includes formats such as Photoshop PSD and any other still image format supported by QuickTime)
- n TIFF
 - n Improvion TIFF extensions (metadata included in the ImageDescription tag)
 - n Leica TIFF (generated by Leica confocals)
 - n Olympus TIFF (generated by Olympus confocals)
 - n PerkinElmer TIFF (generated by PerkinElmer Ultra *View* systems)
 - n GE TIFF (generated by GE Healthcare INCell 1000 systems)
 - n OME TIFF (as described by the Open Microscopy Environment <http://openmicroscopy.org>)
- n Zeiss LSM (this is a TIFF variant)
- n MetaMorph STK (this is a TIFF variant)
- n Olympus OIF (this is a TIFF variant)
- n TILLVision

For writing, Volocity supports the following formats:

- n Windows BMP
- n Volocity Library Clipping
- n ICS/IDS (Image Cytometry Format)

Importing Items (File Menu)

- n JPEG
- n Openlab LIFF
- n TIFF (with Improvion extensions)
- n OME-TIFF (2007 schema, as described by the Open Microscopy Environment <http://openmicroscopy.org>)
- n TIFF for Publication
- n QuickTime Movies
- n AVI Movies

Volocity supports writing views as QuickTime movies and as AVI movies.

Organizing Data in a Library

Overview

This chapter describes:

- n the library format
- n the library menu and toolbar
- n library thumbnails and icons
- n how to set item properties
- n how to create new folders
- n how to copy and move folders and items
- n how to find items
- n how to compact libraries

Library Format

The application creates libraries in a multi-file format, which handles large data sets well and gives fast data access. When you create a multi-file library, it is created within a folder. This folder is labeled with an icon and the name of the library.

Inside the folder are the library file and a data folder, which contains all the data required to view the images and volumes kept in that library. Multi-file library files have the suffix .mvd2.

It is essential that the library file and data folder are kept together, which is why the application creates them together in a separate folder. To open the library, you must first open this folder and locate the library file. If you want to move a multi-file library to another location you must move the whole folder. If you only move the library file, the application will not be able to display any of its contents.

Library View

The Library view shows you a list of all the items in your library. If there are sub-folders or single files containing multiple images within your library, click on the arrow next to the folder/file thumbnail to expand and contract the folder and view/hide the contents. See also page 70.

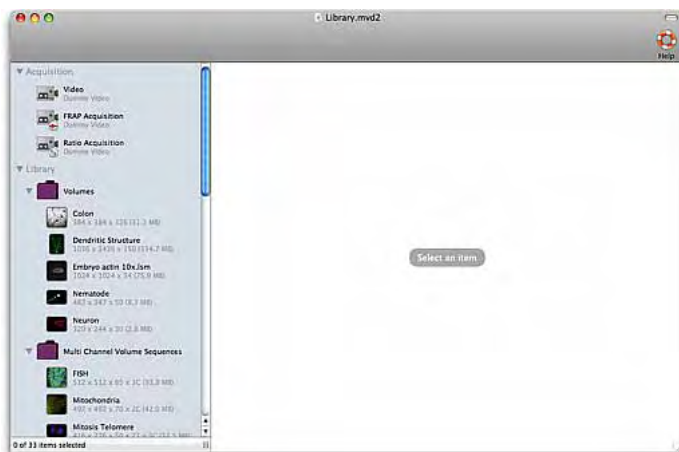

Each item has a name in bold text. This name may be changed to assist organization of data. Click once on an item name to select the item then click again to open the text in a editable field to change the name.

Library Menu

Whenever a Library view is active, the Library menu will be available.

Small Thumbnails, **Medium Thumbnails** and **Large Thumbnails** set the size of image used to represent an item in the library. **Sort by** allows library data to be organised by properties of the data.

Each item is listed with information to assist finding and organizing items. In the case of image sequences this text describes the X, Y and Z dimensions in pixels followed by number of channels and number of timepoints.

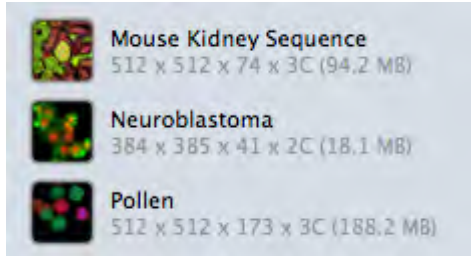

Show Data in the Library menu to display additional information such as the time the item was added to the library or the item type.

Library Thumbnails and Icons

The item's thumbnail tells you what kind of item it is.



This is a folder or multi-layered file.



This is an Openlab LIFF file containing multiple images.



This is a thumbnail of the image, volume or image sequence. Data shown below the name of the item, to the right of this icon indicates XY and Z pixel dimensions, channels and timepoints.



This is a PSF (used with Volocity Restoration, see page 502, also the glossary).



This is a background correction, see page 126.



This is a registration correction, see page 131.



This is a spectral signature (only available with Acquisition), see page 241.



This is a Measurement item (only available with Quantitation), see page 428.

Setting Item Properties (Edit menu)

Every item has a number of properties associated with it.

Some properties are fixed and are assigned by the system, such as the kind, time modified and date modified. Others are user-defined, which provides you with a useful method of recording additional data against an item by which you can also search for items. You can set properties on both 2D and 3D items.

The correct XYZ properties (in micrometers per pixel) are essential for generating correct scale bars, calibrated measurements in Quantitation and the correct application of PSFs in Restoration. These properties effectively set the calibration of the data.

The Volocity file filters read XYZ calibration information from supported file formats when they are imported. Acquisition directly into the application will set the relevant properties automatically.

In the following example, we have set up properties for a single item. To change common properties for several items at the same time, select the required items before selecting **Properties...** from the Edit menu.

1. Select an item and then select **Properties...** from the Edit menu. We have selected an item called "Neuron".
2. Enter properties as appropriate. Use commas to separate multiple entries, for example keywords.

Creating New Folders

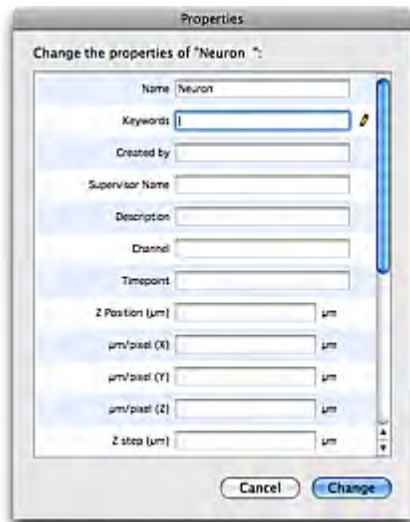

3. Click on **Change**.

Creating New Folders

Create folders to organise data within a library.

1. Select **Create New** from the Actions menu and then select **Folder**. This will create a new, untitled folder as the last item in the library.
2. Drag and drop items into the new folder as required.

Copying and Moving Folders and Items

Copy Items Between Libraries

The most convenient way to move items between libraries is to use the Library Clipping export format. Select the item in the open library, use the **Export...** command and select the Library Clipping format. The Export command allows you to specify a unique name for the clipping file; it will have an .acff suffix. See also page 142.

To copy the clipping file to a new library, open the library and drag and drop the clipping into the library view. You can also use the **Import...** command to import the .acff file into the library. See page 55.

Move Folders into Other Folders

Click on the folder and drag it to the required position in the library hierarchy.

Move Items from One Folder into Another

You can move sub-folders and individual, unrelated image files, such as TIFF files. You cannot move items from multi-layered files, such as Openlab LIFF files or multi-layered TIFF files, because the relationship is set by the source data. Moving the item would change the way the original entry in the library is linked to the source data. If you try to do this, you will be prompted to create a copy of the item.

Copy Items from One Folder into Another

- n If you have tried to move an item from a multi-layered file, click **Copy** at the prompt.
- n Or select the item and use the **Duplicate** command in the Edit menu. This duplicates the item in the same folder and you can drag and drop it into another folder.
- n On a Mac, hold down the Alt key as you drag the item into a different folder. A progress message is displayed telling you that the application is copying the item into the folder.
- n On a WINDOWS, hold down the Ctrl key as you drag the item into a different folder. A progress message is displayed telling you that the application is copying the item into the folder.

The copied item is automatically adopted into the library so you will be able to make changes to it without changing the source data.

Finding Items (Edit menu)

The Find command allows you to quickly locate images within a library.

1. Select **Find** from the Edit menu.
2. Enter the search criteria, as appropriate. You will be able to select from a number of search criteria.

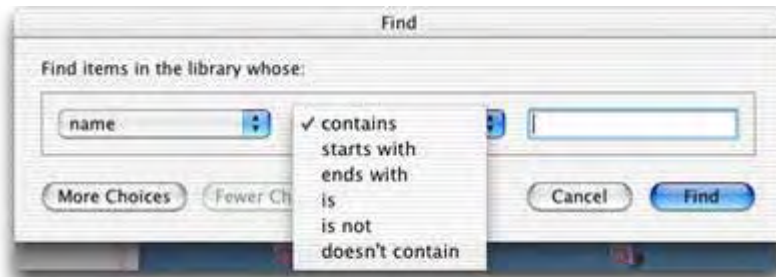

3. Click **Find** to display the Search Results window, which is displayed as a gallery of items. The Results menu contains the same commands as the Gallery menu described on page 113.
4. Double click on the required item in the Search Results window to open it in a new window.

5. If you want to enter multiple search criteria, select **Find** again and click on the **More Choices** button.

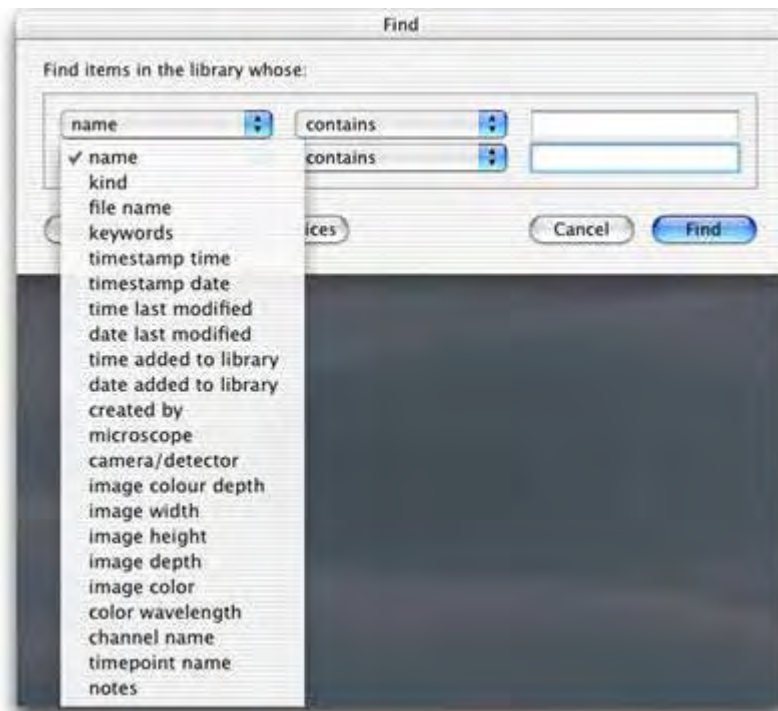

6. Enter as many search criteria as required and click on **Find** to display the search results.

Note: Find remembers the search criteria, so use the **Fewer Choices** button if you want to remove search criteria that you have already set up.

Delete/Remove Items from a Library

Highlight the item(s) to be removed and select **Remove Items** from the Actions menu. Edit menu, **Undo** command will reverse the last action including Remove Items. Items cannot be removed if they are part of a linked file that is not adopted into the library.

To remove part of an item, for example a selected channel, an ROI (region of interest), a measurement item row, select the part that is to be removed and use delete (Windows) or backspace (Mac OS).

Locating an Item (Actions menu)

The **Show in Library** (see page 113) and **Reveal in Finder/Explorer** commands in the Actions menu allow you to quickly locate an image link in the library or the source data in the Finder (Mac) or Explorer (WINDOWS).

Reveal in Finder/Explorer

This command works from a Library, Single Image or Gallery View and highlights the location of the source data for the selected item in the Macintosh Finder or Windows Explorer. If the source data has been removed from the hard disk, the application just displays the Finder or Explorer. If the source data was on a removable medium, it prompts you to insert the relevant disk or medium.

Compacting Libraries

Even though libraries will increase in size under normal use, Volocity will always make best use of available disk space. However, when moving or backing up libraries you may like to use the Compact Library command. This optimizes the library size. Cached data includes stored rendering settings, therefore, it may take longer to view data once the library has been compacted.

1. Select **Compact Library...** from the File menu.
2. Leave the checkbox selected to **remove cached data and preferences**. Then click on **Compact**.

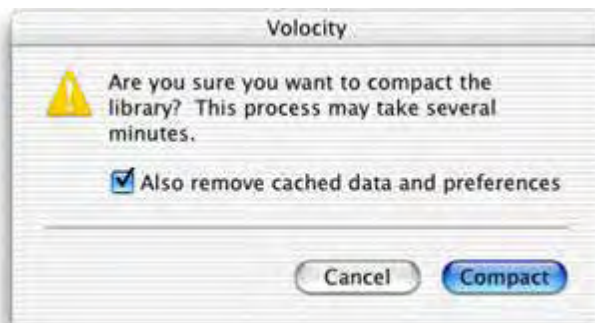

Views on Data

Overview

Once you have added data, you can view library items and items within an image sequence in a number of different ways. Each type of view has its own window, menu and toolbar. View-specific menus and toolbars contain commands that are particularly relevant to that view. The menu title and/or contents will update according to the active view.

This chapter describes:

- n the Library View
- n item selection
- n the Image View
- n the Image Sequence view
- n the Voxel Spy tool
- n the Gallery View, menu and toolbar
- n the Notes tab
- n snapshots
- n how to show data
- n how to sort items

Library View

The Library is your base for working in Volocity. Files imported or acquired are added to the database and access to them is via the Library view.

You cannot capture an experiment using Volocity Acquisition without first opening a library.

Volocity opens first to an empty library view containing shortcuts to the common actions.

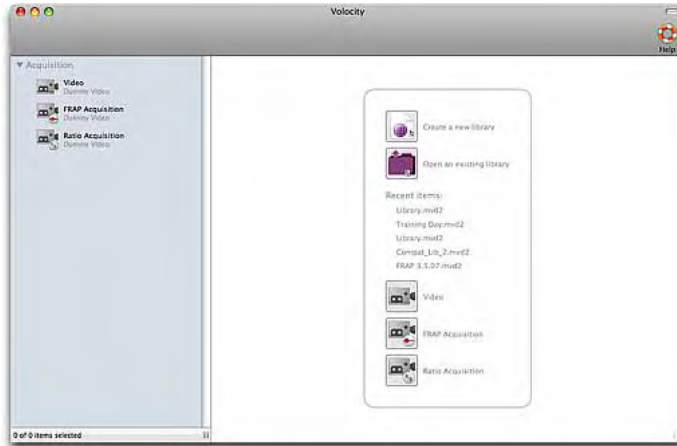

Video shortcuts are only available if the system is licensed for Volocity Acquisition, FRAP and Ratio.

Existing libraries and recent items can also be opened using the options in the File menu.

The Library View shows you a list of all the items in your library. If there are sub-folders or single files containing multiple images within your library, click on the arrow next to the folder/file thumbnail to expand and contract the folder and view/hide the contents.

Click on arrow to expand/contract an item

Click on a thumbnail or item name to select it. If you click on the name whilst it is highlighted you can edit the text.

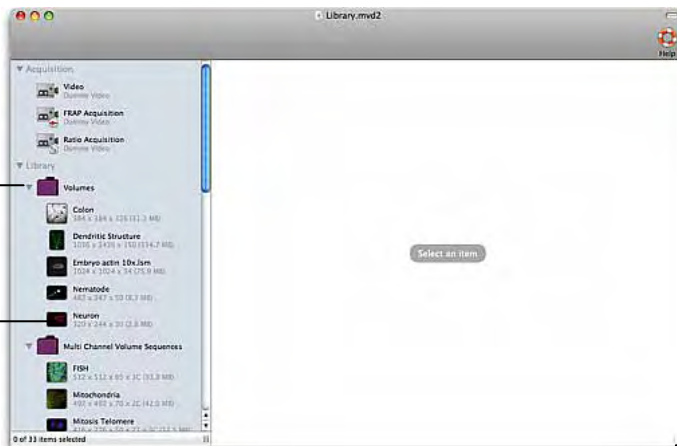

Click and drag to expand/contract the window

A single click on an item listed in the library on the left will show a view or views on that item in the area on the right.

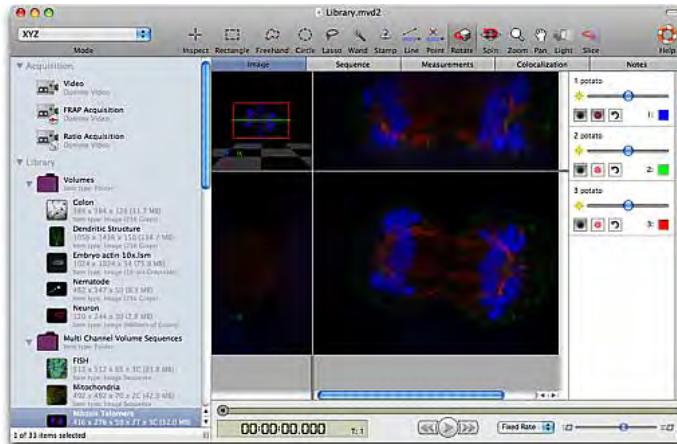

The views and options that are available will depend on the nature of the data, particularly whether it is 2D or 3D, and the Volocity products licensed on your system. See the sections on the Image view (page 73) and the Visualization (page 301) and Quantitation (page 376) products for more details.

Double click on an item in the library to see it in its own window. Multiple views of the same item may be shown.

How Do I Look at Items in the Library?

Click once on an item in the library list to view it in the single window layout.

Double click on an item to open the item in a separate window. Use the Window menu as necessary to move between multiple open windows.

The window will have a toolbar and a number of tabs that allow you to display different views of the image data. The type of item determines what tabs and tools are available.

- n If you click once on a single image or an image sequence, the item will be displayed in an Image view (see below).
- n If you click once on a folder or multi-image file, you will display the contents in the Gallery view (see page 113). If there are sub-folders, you can double click on those to view the contents in a separate gallery window.
- n If you click once on a PSF, background correction, registration correction or spectral signature you will display a view which contains the parameters used in creating that item which will confirm its application to image data.

Note: It is possible to open the same data in multiple separate windows. Double click on the item in the library list and repeat until the required number of instances are open. This extremely useful feature allows you to compare different views of the same data.

Selecting Items in the Library

You select items in the library in the same way that you select items in Macintosh Finder or Windows Explorer.

- n Click on an item thumbnail or item name in the library list to select the item. A view of the item will be shown to the right of the list.
- n To select a group of consecutive items, hold down the shift key and click on the first and last item in the group. No view is shown for multiple items.
- n To select multiple items not in sequence, hold down the Apple key on the Mac or the Ctrl key on Windows and click on the required items.

See “Organizing Data in a Library” on page 59 for more information about working with the Library View.

Status Bar on Windows

The status bar is a standard Windows feature that appears in all views on the PC at the bottom right-hand corner of the application window. This is also the first place that progress information is displayed, even before a progress bar is posted to the screen. Error messages may also appear in the status bar.

Image View

When you single click on an image item in the library list or click on the Image tab within an item that is already open, the data is displayed in an Image view. Whenever an Image view is displayed, the Image menu is enabled and the toolbar updates to show tools that are appropriate for the image data.

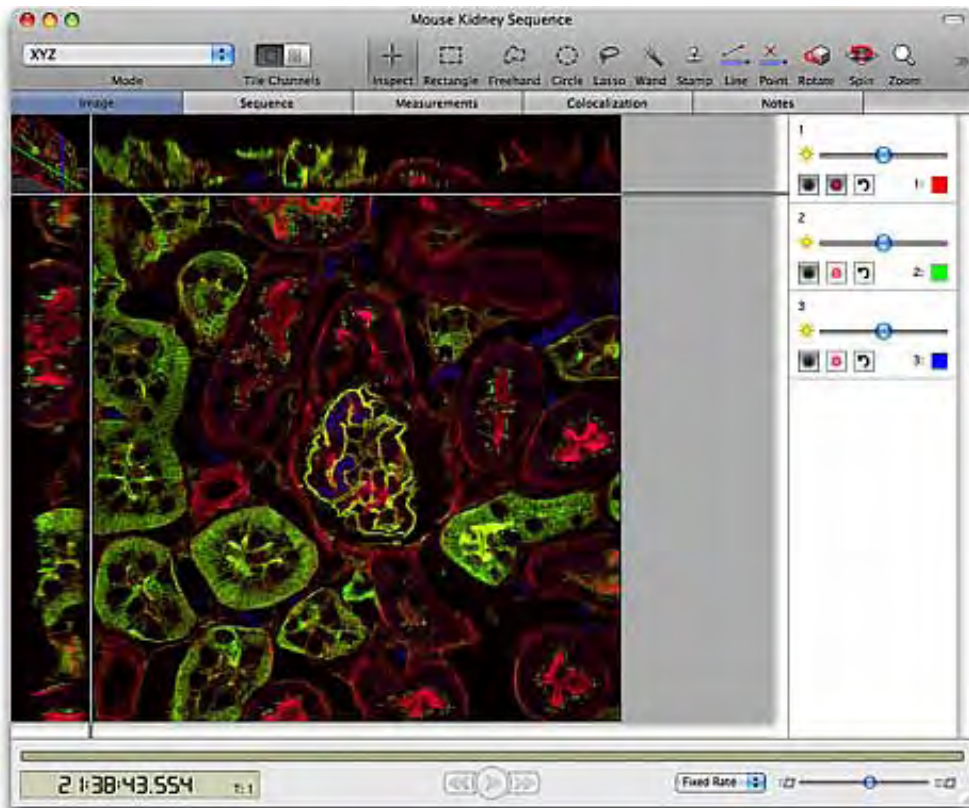

In an image sequence, the view can display a brightest point merge of all the channels or tiles of the individual channels and a merge. Tiled channels are not available for all Image view modes..



The tiled channel button will be greyed out when using a mode that does not support tiled channels. If channels are tiled and a mode which does not support tiling is selected the view will revert to overlaid channels.

By default channels are overlaid as brightest point merge. This may be changed using the **Overlay Channels Using** options in the Image menu.

Change the contribution of individual channels and show or hide channels using the channel controls on the right hand side of the view. If the channel controls are not visible go to the **Image** menu and select **Show Channels**.

Reference Images

Volocity supports a mixture of 2D and 3D images in a sequence when the 2D images are designated as reference images. Reference images are used for showing overall morphology or orientation information where the detail of 3D is not required. For example a Differential Interference Contrast (DIC) or other brightfield reference image is used to show cell membranes to confirm total number of cells in a field. Similarly a labeling of the nucleus could be imaged as a fluorescent reference channel. Visualization of reference images varies with Image View mode and will have different channel controls.

Reference images are ignored by measurements made by Volocity Quantitation.

Volocity Acquisition supports the creation of image sequences with reference channels using the Reference tab in the Acquisition Setup dialog. Some file formats supported by Volocity may contain reference images and Volocity will import these with the 3D data. Create reference images from 3D channels using the option in the Sequence menu.

Mode

Change the Mode to present the data in different ways. Modes available depend on the products licensed and the nature of the data. For example 3D data may be viewed in XYZ, XY, XZ, YZ, Extended Focus or 3D Planes. 2D data may only be viewed in XY.

Use tools from the toolbar to explore the Image view. Toolbar items will be enabled or disabled according to the mode displayed. Change the tile size of tiled channels using the slider in the bottom of the image.

2D reference images included in 3D data are shown in many modes of the Image view.

Bookmarks and movies created in one mode may be applicable to other modes if the changes stored in the bookmark can be shown in the view.

The following options are available with all Volocity products. If Volocity Visualization is enabled additional modes will be available. See the Volocity Visualization section.

2D Items

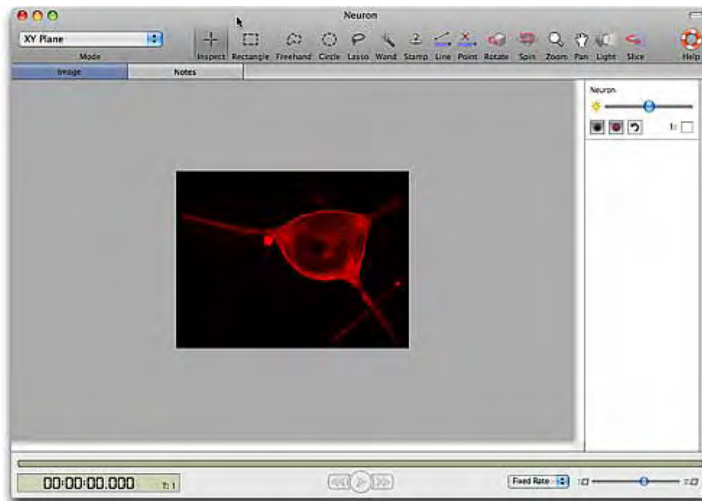

3D Items

XYZ

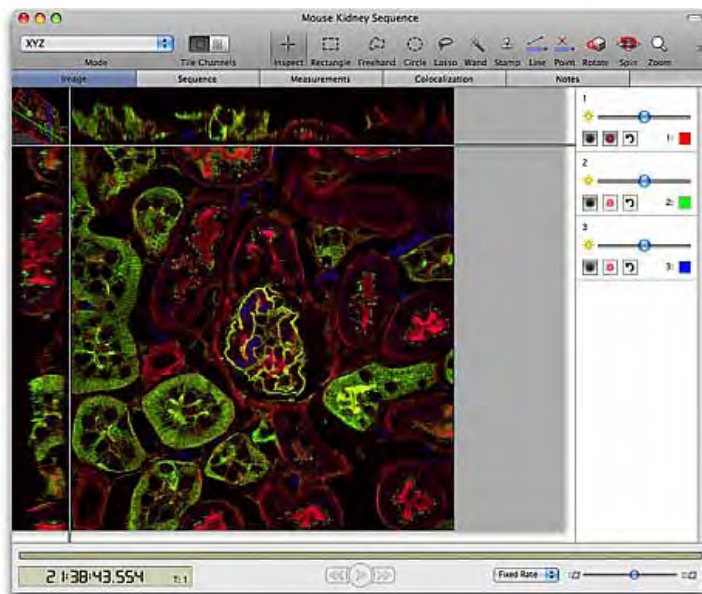

In this mode reference channels will be shown at the appropriate z position in the XZ, YZ and 3D planes part of this view but will always be overlaid on the XY plane.

Image View

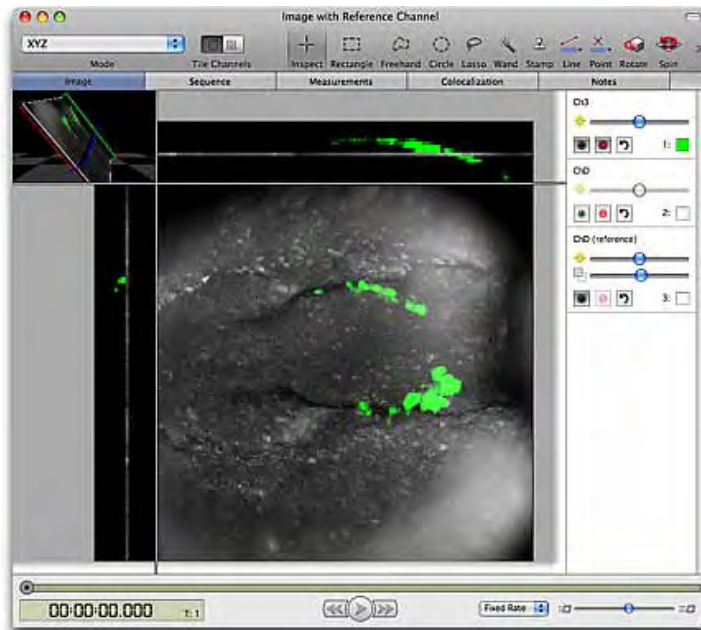

The XYZ mode is made up of four components which may be displayed individually by choosing the mode in the popup.

The XYZ mode does not support tiled channels.

XY Plane

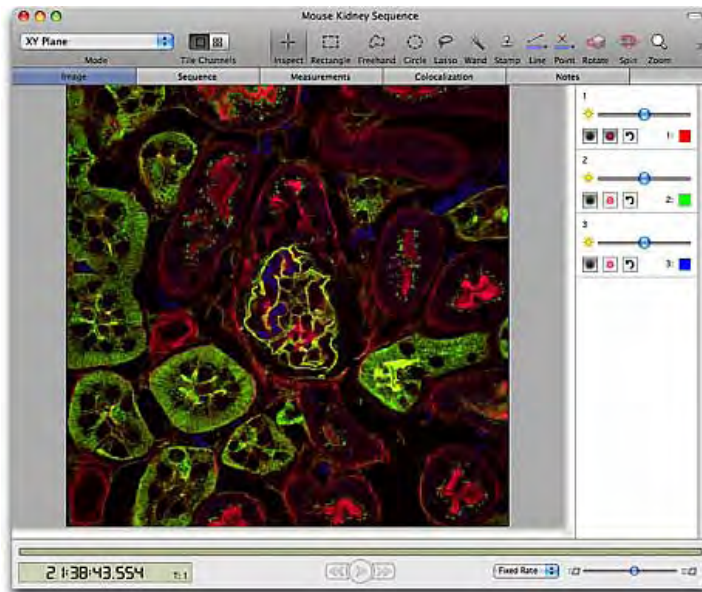

Overlaid channels.

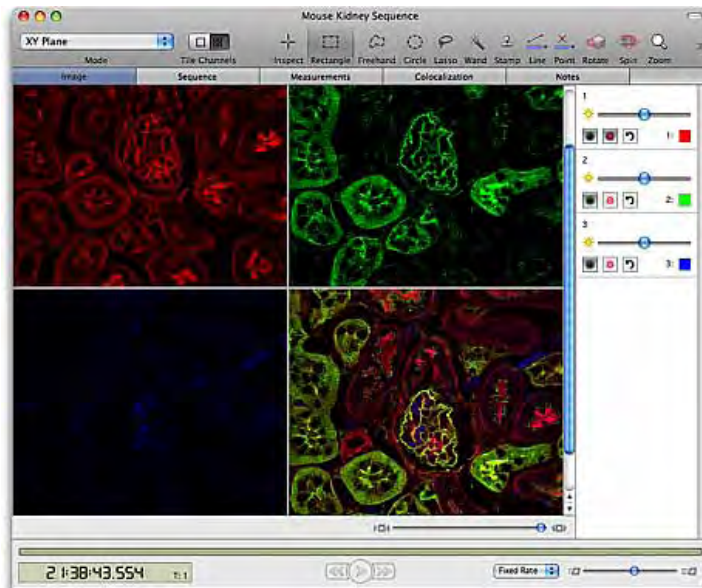

Tiled channels.

XZ Plane

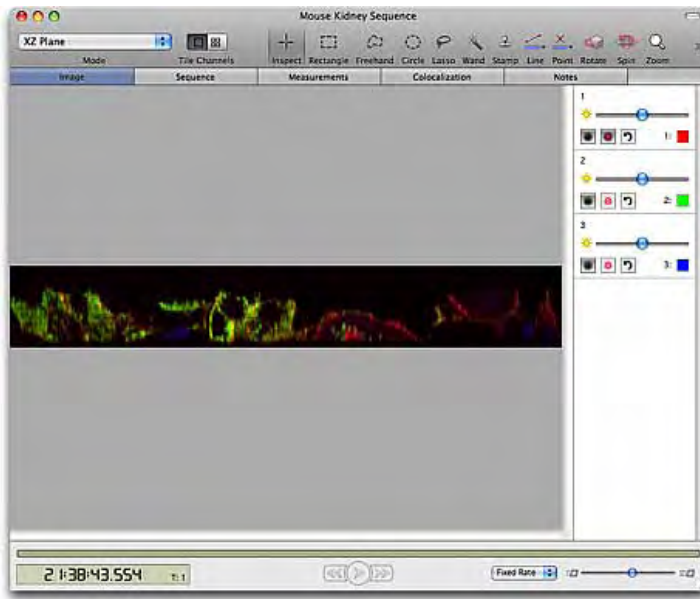

YZ Plane

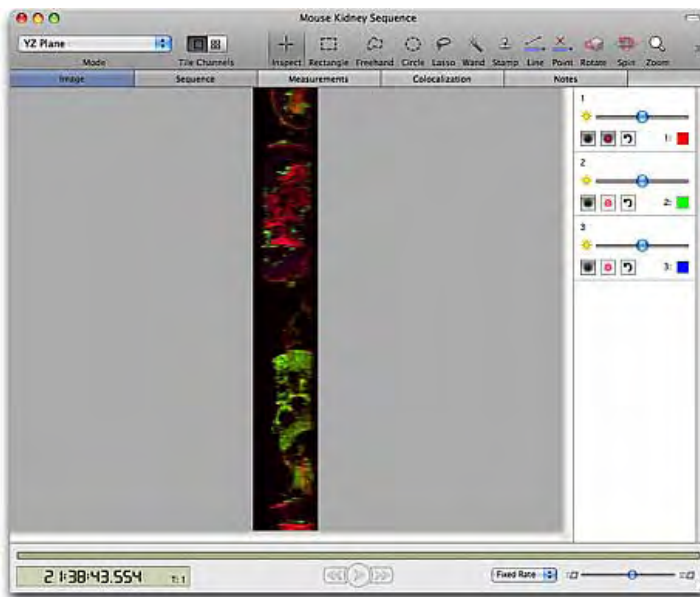

The XZ and YZ Plane modes support tiled channels.

3D Planes

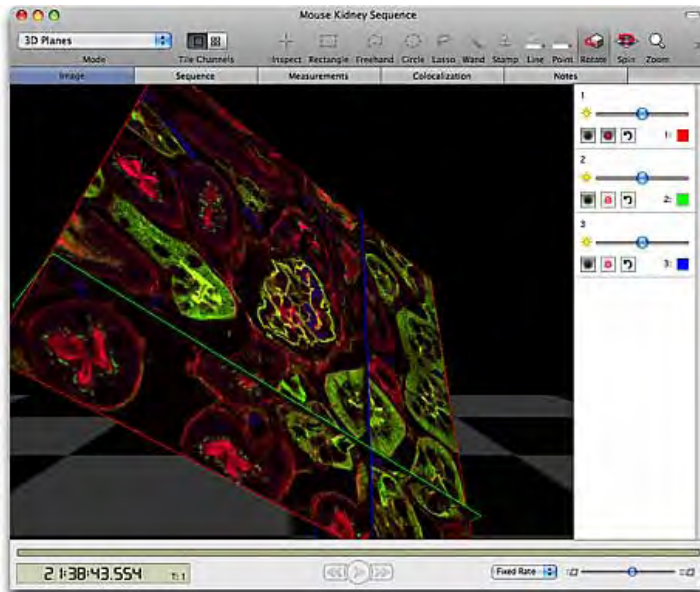

The 3D Planes mode supports tiled channels.

Extended Focus

The Extended Focus mode displays a brightest point merge of all planes in the image.

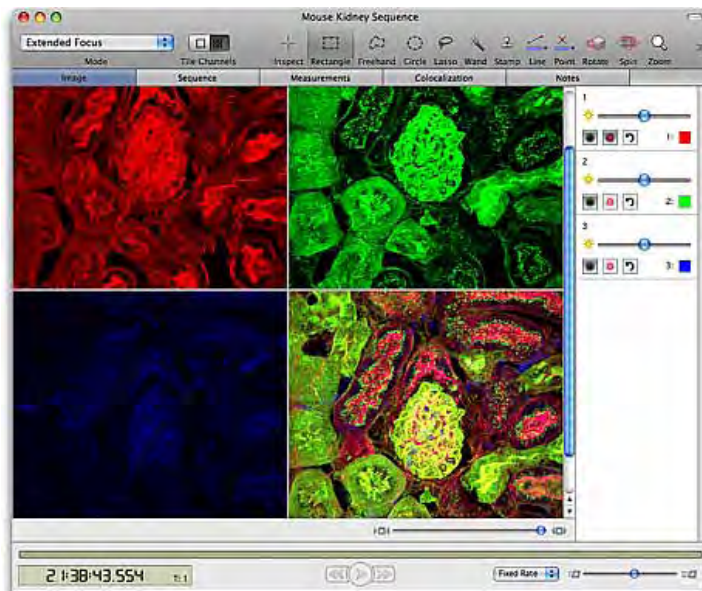
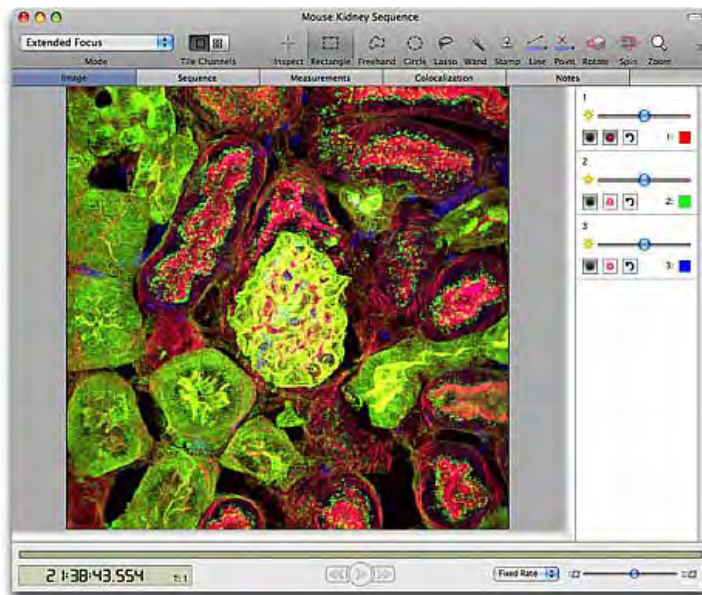

Selections can be made within the volume, using the tools in the Image View toolbar, and measurements can be made from these selections. Note that the volume and all selections made are three-dimensional and have depth and volume.

Z Planes

The 3D image viewed as individual z planes. Channels are overlaid. The Z Planes does not support tiled channels.

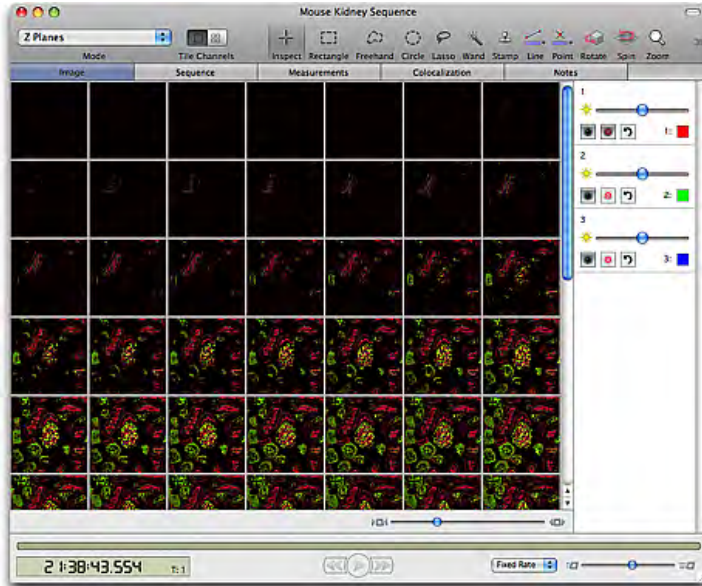

Channel Controls

In an image view the controls for working with the individual channels in a dataset are shown to the right. If these are not visible select Image menu, **Show Channels**.

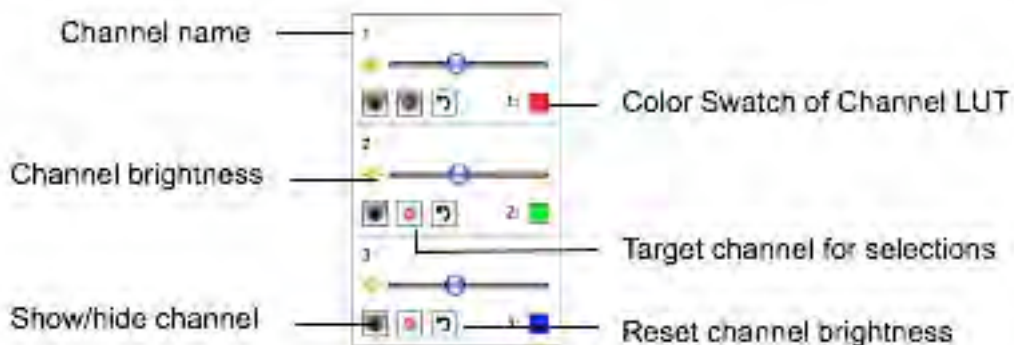

- n Turn channels on and off by clicking on the show/hide channel button
- n Target channels using the “Target” button. Some tools make different selections depending on which channel is used as the basis for selection. For example, the magic wand tool (see page 87) works on voxel intensity so the size and shape of the selection made by the tool can be very different according to which channel is targeted when the selection is drawn. For more information see page 383.
- n Increase or decrease the contribution of individual channels to the final image, using the slider bar for the channel. This will make the channel appear brighter or darker in relation to the others.

Channel Controls for Reference Channels

When a single-plane reference channel is present in a 3D image the different nature of the channel is indicated by the text (reference) in the channel name. In addition to the controls for the channels above the reference channel has an opacity slider to control the opacity of the reference image in the **3D planes** part of the Image view only.

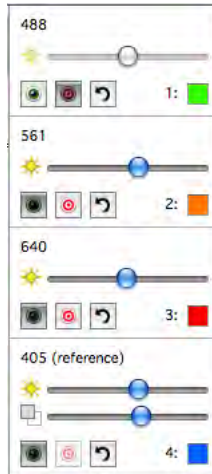

Time Navigation

If the image sequence contains more than one timepoint the time navigation controls will be enabled. Move through time resolved data in an image view using the time navigation controls across the bottom of the view. If these controls are not visible select **Show Time Navigation** from the Image view.

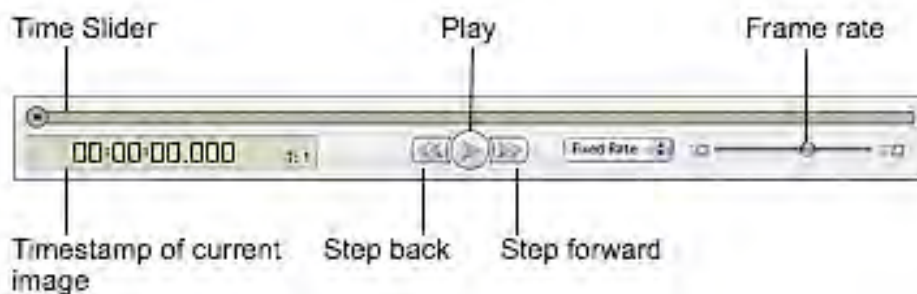

Play the sequence back at a fixed rate (number of frames per second set by the slider) or real time (for example 10x acquisition rate, again set by the slider).

Set the mode of playback by selecting **Loop Sequence** or **Shuttle Sequence** from the Image menu. If, because of the size of the data or capabilities of the hardware each timepoint cannot be loaded at

Image View

the rate specified by the slider **Skip Timepoints** will miss out timepoints as necessary to maintain the frame rate.

Image Toolbar**Mode**

Select the display mode for the image data. Modes available will depend on the dimensions available in the data. 2D data can only be shown as an XY Plane. 3D data may be shown as XYZ Planes, and any part of the XYZ Planes view independently. Other modes may be available with additional products such as Volocity Visualization.

Tile Channels

Select the display of channels within the image. Channels are overlaid or tiled as individual channels plus the overlay. Not all modes of the Image view support tiled channels. In these modes the tiled option is grayed out.

Inspection Tool**Shortcut key I**

Use the cross-hair tool to position the pointer on any of the planes and drag to explore the Image view moving through the different parts of the slices. The cross-hairs will be labelled with the current X,Y,Z coordinates. The Inspection tool also operates in XY, YZ and XZ modes, moving in two axes simultaneously to explore the data.

Note on the screen how the cross-hair colors are different for each plane and are also shown on the 3D preview in the top left-hand corner.

Image View

YZ, blue

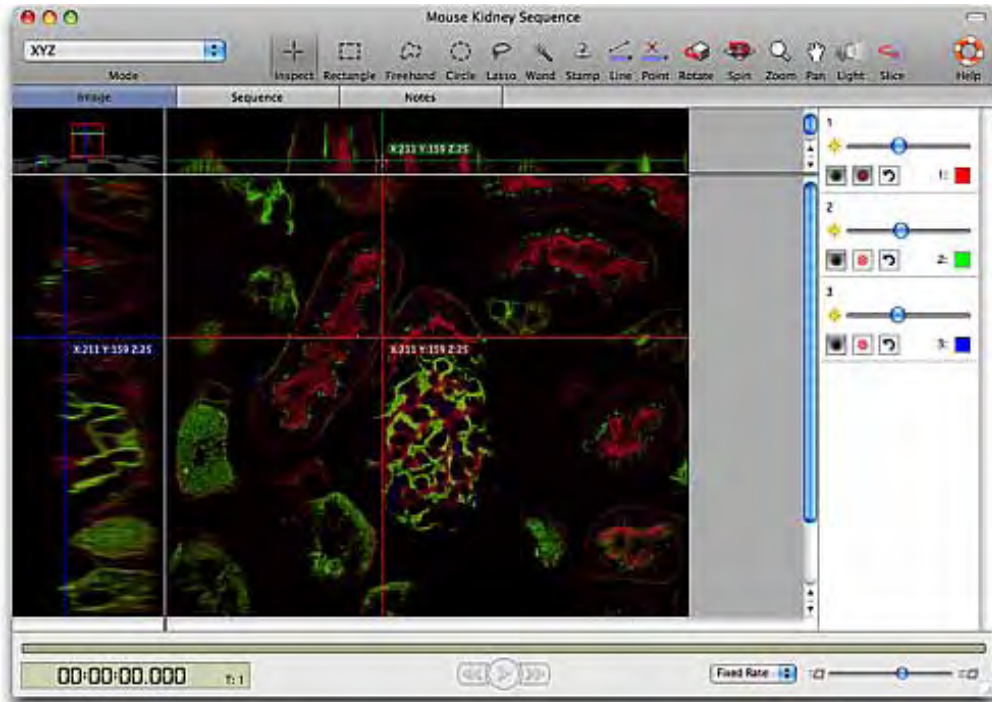

XZ, green

XY, red

Zoom and Pan Tools



Shortcut key Z

Image views show zoom to fit behaviour. When the window containing the view is made larger or smaller the image will be scaled accordingly. Use the zoom tool to zoom in by multiples of the original size. Click with the tool to zoom in. On a Mac, Alt-click zooms out again. On a PC, use Ctrl-click. When the zoom tool is active an overlay on the image shows the percentage zoom. Double click on the zoom tool icon to restore zoom to fit behaviour.



Shortcut key H

On 2D Image and Movie Views, use the Hand tool to pan through a magnified image. On 3D Image Views, use the Hand tool to pan the XYZ planes. Over the 3D cross-section the cursor will always appear as a hand. Click and hold, then spin and release to make the preview tumble. Use Alt-click (Mac) or Ctrl-click (WINDOWS) and drag to zoom the 3D cross-section.

Selection Tools

Use the Selection tools to draw regions of interest (ROIs) and lines on the image. Although the tools are available with all versions of Volocity, they are mainly used for measuring with Volocity Quantitation. Refer also to the chapter on "Volocity Quantitation" for worked examples using these tools for measurements.



Shortcut key R

The Rectangular ROI selection tool is available for all image data. It allows you to draw rectangles or squares.



Shortcut key S

The Lasso tool allows you to trace the outline of a selection. The Lasso tool selects regions based upon the color similarities of adjacent pixels. The initial point clicked sets the color to compare and the tool has the effect of shrinking around the pixels that fall outside of the tolerance value.



Shortcut key C

The Elliptical ROI selection tool allows you to draw ovals or circles.



Shortcut key F

The Freehand tool is available for all image data. It allows you to make a freehand selection of an area on the image.



Shortcut key W

The Magic Wand tool is available for all image data. It allows you to select regions based upon the color similarities of adjacent pixels. The initial point clicked sets the color to compare. This tool has the effect of expanding outwards from the original color.



The Line tool is available for all image data, but is of limited use without the Volocity Quantitation functionality. Use it to add lines in the Image View. The tool draws a straight line between points that you specify by holding down the Shift key and clicking with the cursor. Line length and an intensity profile overlay are shown on the image if set in the view options. You can have any number of points in a single draw action, as long as you hold down the Shift key. When you release the Shift key, Volocity assumes that the last click was the end point. Click on the points within a line to move or delete.



Use the Point tool to count objects or features visible in the image.

Tips on Using the Selection Tools

Once you have selected an area, you can also use the **Copy** command from the Edit menu. **Cut**, **Paste** and **Clear** commands are only active if the item is adopted (see page 117).

As long as the selection is still active, you can use the pointer to click in the selected area and drag it to another part of the image.

The following key combinations also apply:

Macintosh

- n Control-drag on a selection centers the selection on the image.
- n Command-drag locks the dimensions, to make a square or circular selection rather than oblong or oval.
- n Shift allows you to add to the ROI or draw multiple ROIs.
- n Shift + alt (option) allows you to subtract from the ROI or subtract the whole of the existing ROI by drawing around it.
- n Alt (option) carries out an AND operation leaving only the intersection of the two ROIs.

Windows

- n Shift allows you to add to the ROI or draw multiple ROIs.
- n Shift + ctrl allows you to subtract from the ROI or subtract the whole of the existing ROI by drawing around it.
- n Ctrl carries out an AND operation leaving only the intersection of the two ROIs.

ROI Options

The ROI is shown as marching ants on the Image View with color projected onto the image to highlight the area of interest. You can define the color and transparency used for the ROI.

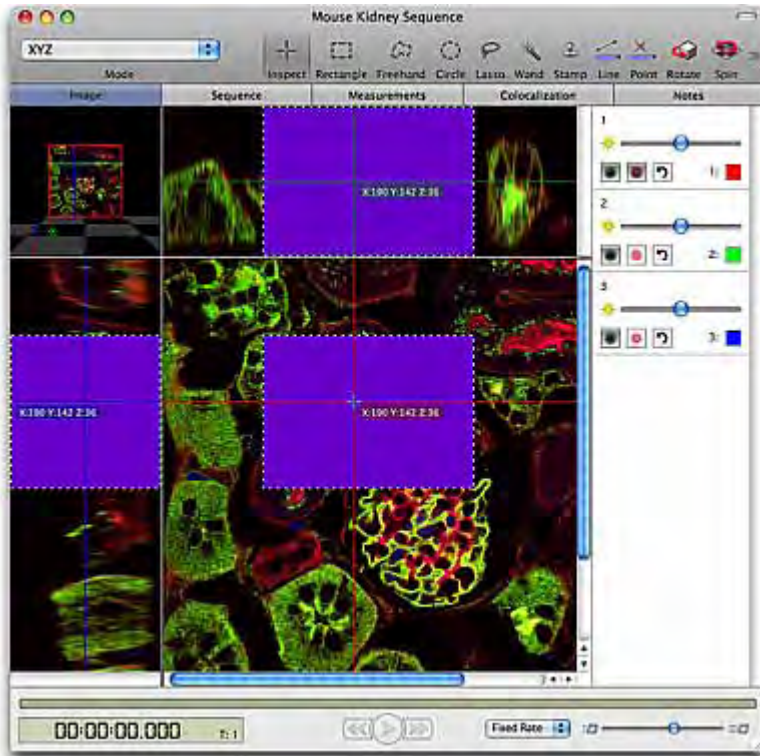

Marching ants outline the ROI

Color block shows projection of ROI on each plane

1. Select **View Options...** from the Image menu. Click the ROI tab.

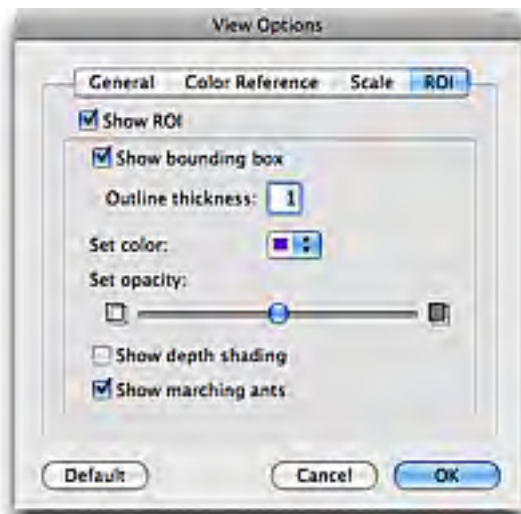

2. Use the ROI color drop-down menu to select the required color and use the slider control to set the ROI opacity.
3. Click on **OK**.

Image Menu

Whenever an Image View is active, there is an Image menu available in the menu bar. The menu commands are appropriate to the type of image data. For example, some options are only shown for 3D images.

Mode sets the visualization for the view. The same options are available in a pop-up on the tool bar and change the way that the image is displayed. For example a 3D image can be visualized as planes in XZ, YZ and XY or just one of these at a time. Volocity Visualization adds options to this list.

Stereo is only applicable for an image being viewed in 3D rendering and therefore discussed in the section on Volocity Visualization.

Show/Hide Channels, Bookmarks, Movie and Time Navigation will change the panels of the Image view that are visible.

Display sub menu selects items that can be shown as part of the image; scale, color reference, timestamps etc. Use the **Smooth Zoom** command to apply interpolation to the view to give better quality when viewing zoomed images and automatically set the best quality for printing.

Capture Snapshot is described on page 113, **Create QTVR** is available with Volocity Visualization only and is described on page 323. These are both for creating output from the Image View that may be shared with other people.

Loop Sequence, Shuttle Sequence and **Skip Timepoints** select the playback mode for time resolved data. Use the Time Navigation controls to start and stop playback (see page 83).

Next in the menu come a series of options which will apply overlays to the image or change elements of the view. These are not permanent changes and the menu item will change to the opposite to allow any change to be reversed.

Reset View will return the view to its default appearance.

If an image timestamp has been displayed using **Show Time Absolute Times** or **Relative Times** will affect the format the timestamp is shown in.

When viewing the image view of an image sequence consisting of two or more channels, the user can choose the method that is used to merge the two channels for display from the **Overlay channels using** sub menu.

- n Brightest point: The brightest intensity in the source images is displayed.
- n Accumulate: The total intensity of the voxels in the source images is displayed.
- n Average: The average intensity of the source images is displayed.

Show Time

The timestamp of an image in an image sequence can be shown when viewing the Image View.

- n Select **Image** menu, **Display, Show Time** or **Hide Time** to toggle the timestamp on or off.
- n Select **Absolute Times** or **Relative Times** to choose the style of timestamp to be displayed.
- n Select **Image** menu, **View Options...** On the General tab use **Frame time color** to change the color of the timestamp.

Showing Color Reference

On all Image Views, apart from millions of colors images, you can display a legend that shows the colors in the image and the values they represent.

Image View

To display this legend, select **Display Show Color Reference** from the Image menu.

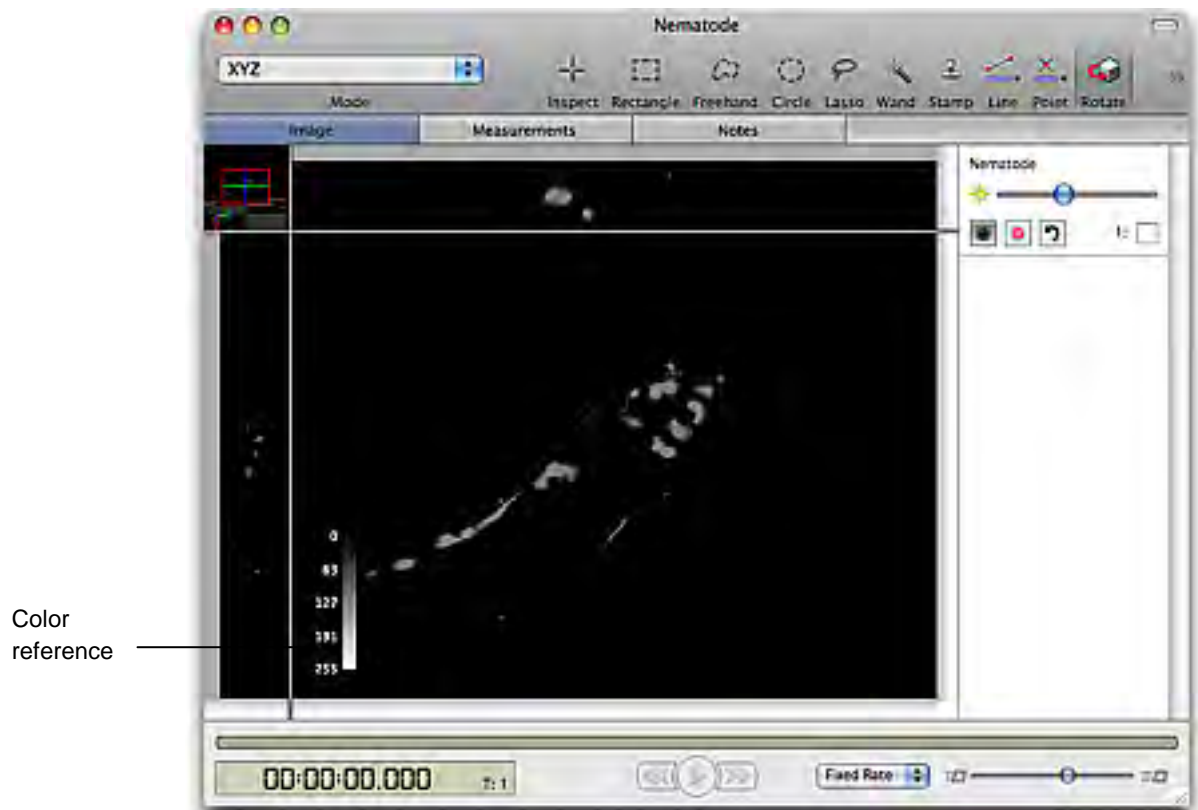

The color reference may be moved to any corner of the XY area of the image view.

Note: There is a separate color reference for each visible channel. Therefore, if multiple channels are shown in the channel controls, multiple legends will be displayed. Hide unwanted color references by hiding the channels from which they are derived on the channel controls

Select Image menu, **View Options...** and the Color Reference tab choose how the color reference is displayed.

Showing Scale on Images

Whenever an Image View is active, you will also be able to display scaling information. Select **Image** menu, **Display>Show Scale**.

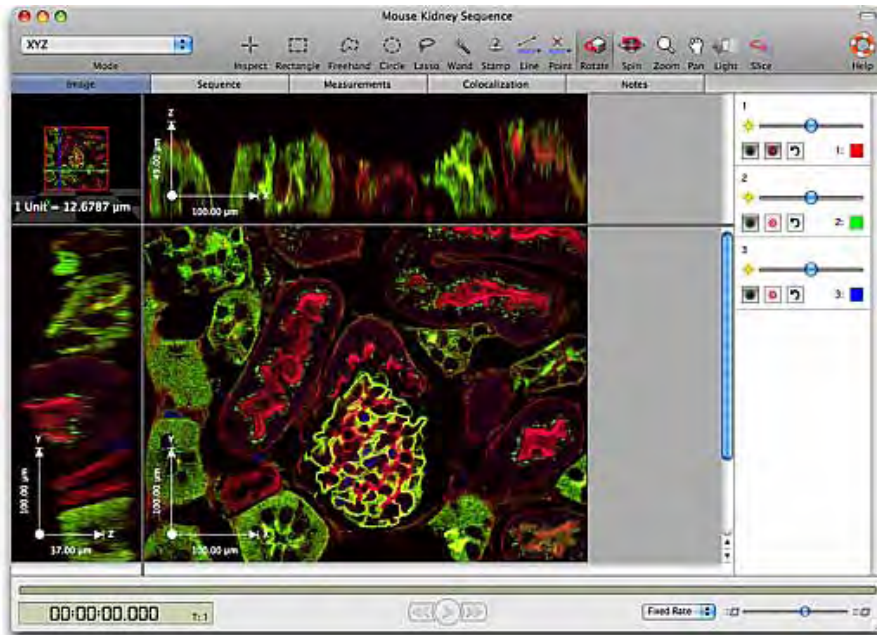

Use **View Options...** Scale tab to show/hide labels

- n The scale displayed will depend on the properties set for the size of voxels in the X,Y and Z dimensions. Choose **Properties...** from the Edit menu to check these values and ensure the correct scale is displayed.
- n Use **View Options...** and the Scale tab from the Image menu to change how scale is displayed.
- n Move the scale to any of the four corners of the image by dragging it.
- n Extend or shorten the scale bar by clicking and dragging one end of it.

Showing Line Profile on Images

Draw a line across the image to show an overlay displaying the intensities along that line. A different overlay is added for each line drawn and the intensities for different channels are shown in the respective colors of the channels.

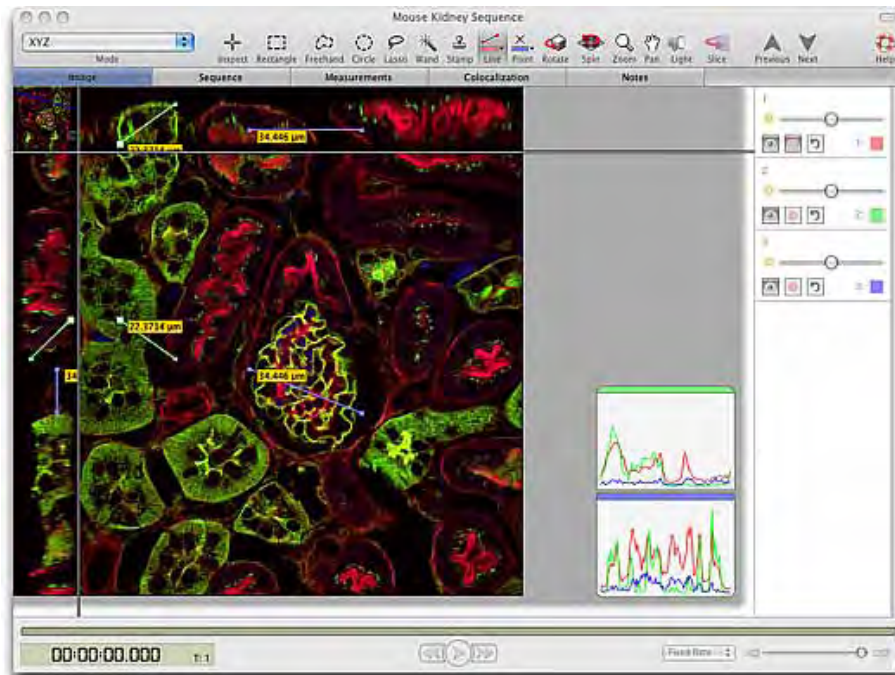

The colored band at the top of each profile reflects the color of the line. Note that the line may be positioned anywhere in 3D space using the XYZ mode of the Image view.

If the line profile is not visible turn it on in the General tab of the View Options dialog.

Capture snapshot (see page 113) will create a snapshot with the currently active line profiles captured to the right of the image.

Reference channels are ignored by the line profile tool. Intensity profiles will only be available for the 3D channel(s) in a dataset containing reference channel(s)/

View Options

The **View Options...** dialog is available in the Image menu. This is a tabbed dialog with options for:

- n **General:** showing the length of lines drawn using the line tool, showing the line profile and the color of image timestamps shown on the Image view
- n **Color Reference:** to change the nature of the color reference overlay, its orientation, color and caption
- n **Scale:** to change the style, color and labeling of the scale bar overlay
- n **ROI:** to change the appearance of ROIs in the image view

Bookmarks

Bookmarks record information about the position and appearance of the data in the Image view allowing a way of viewing image data to be reproduced and compared.

Bookmarks do not store zoom level of the image, the status of overlays on the image such as time or scale, nor will they store and therefore turn on or off any measurement feedback that maybe shown in a view when the bookmark is made.

Bookmarks are stored in a panel to the left of the image data. If this panel is not already visible select Image menu, **Show Bookmarks**. When the view appears as required select Image menu, **Add Bookmark**. Settings controlled by the channel controls or the tools for positioning items will be stored in the bookmark. Overlays turned on or off by items in the Image menu e.g. scale and time are not stored by bookmarks.

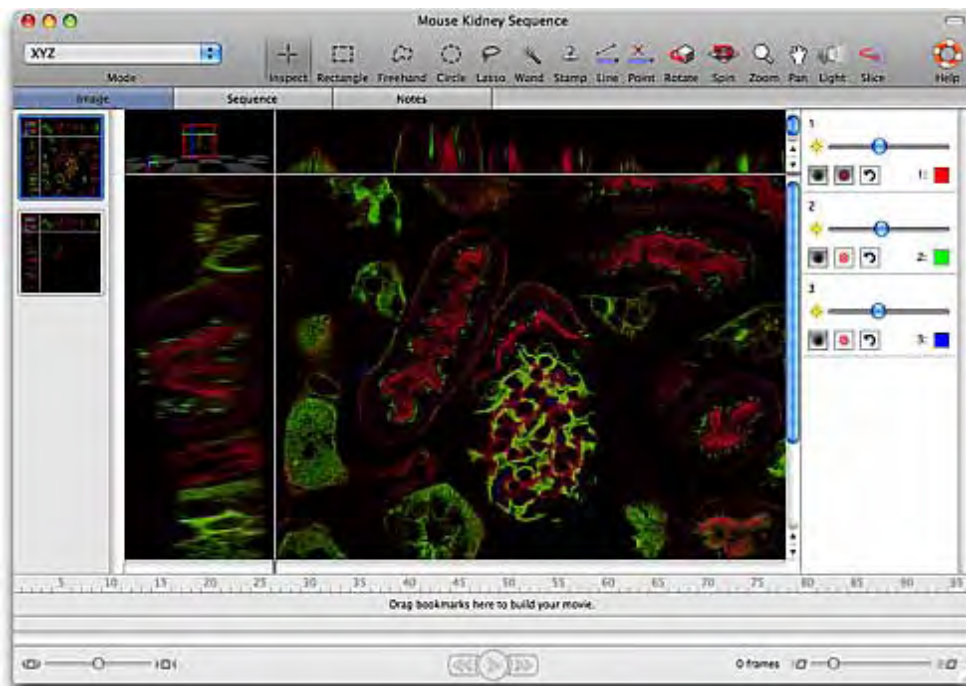

To Use a Bookmark

Double click on the thumbnail of a bookmark in the bookmark pane to use the settings of that bookmark to change the position and appearance of the Image view to those stored by the bookmark. Alternatively use **Next Bookmark** or **Previous Bookmark** in the Image menu to step through bookmarks in the order in which they were created.

To Edit a Bookmark

Select the bookmark in the bookmark pane, the borders of the bookmark will become highlighted. Select Image menu, **Edit Bookmark**.

A dialog is opened showing the states of the view that are being stored.

Uncheck a state and that part of the bookmark setting will not be applied to the Image View when the bookmark is used.

Check the state again and the setting(s) stored when the bookmark was created will be applied when the bookmark is used.

To Move a Bookmark

To use the settings of one Image view with another data sets so that the two data sets may be compared, move the bookmark from the first Image view to the second.

With both data sets open in the image view with the bookmark pane visible drag the bookmark from one to the other.

The bookmark thumbnail will update the first time it is used with the new dataset.

To Delete a Bookmark

Select the bookmark in the bookmark pane, the borders of the bookmark will become highlighted.

Use the Delete (Windows) or Backspace (Mac OS) keys to delete the bookmark.

Movies

You can animate an Image View using bookmarks and the movie interface in the Image View.

Bookmarks are the starting point for making movies in this way. The movie will be an animation of the transition between the appearance of the volume in one bookmark and its appearance in the next bookmark. Each transition takes place over a number of frames determined by you. Select **Show Bookmarks** from the Image menu to view the bookmarks pane.

1. Choose **Show Movie** from the Image menu. The movie pane will appear at the bottom of the screen.
2. Drag a bookmark thumbnail from the bookmark pane to the movie pane. The movie pane will be highlighted when the bookmark is in position. Drop the bookmark at this point to create a keyframe in the movie. By default this keyframe will be 10 frames long. Keyframe length may be changed by clicking and dragging the end of the keyframe.

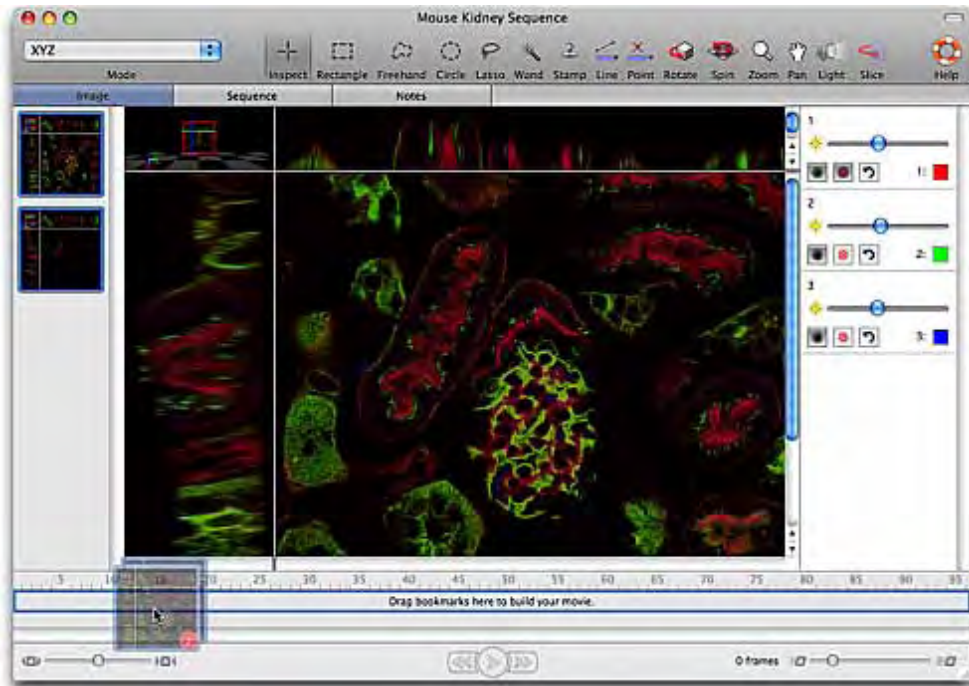

3. Drag a second bookmark into the movie pane. When the movie plays, the volume will be gradually changed in appearance from the first bookmark to the second, this transition taking as long as the number of frames over which the first keyframe extends.
4. Continue dragging bookmarks in to the movie pane to make a series of keyframes/transitions.
5. To include switching between timepoints in a movie made for a time resolved sequence select **Add Timepoint Sequence...** from the Movie menu. Configure the dialog so that the timepoints are changed in the way and at the rate required.

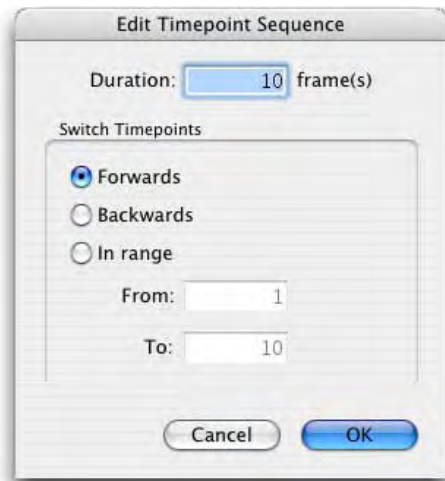

This will add a time bar to the movie which can be configured to last any number of frames, switching between timepoints backwards or forwards and even switching between a subset of timepoints. More than one timepoint sequence may be added to a movie to achieve the behavior desired.

2. Delete a keyframe or timepoint sequence from the movie by clicking on it once to select it then using the Delete key (Windows) or the Backspace key (MacOS). Change the length of keyframes by clicking on and dragging one end of the bar.
3. Preview the movie on the current Image View using the controls at the bottom of the movie pane.
4. Generate the frames of the movie as an image sequence in preparation for export. Select Movie menu and **Make Movie**.

Controls related to the Movie under creation will be in the Movie menu.

Edit Keyframe

Double click on a keyframe or select **Edit Keyframe...** from the Movie menu to access the Edit Keyframe dialog.

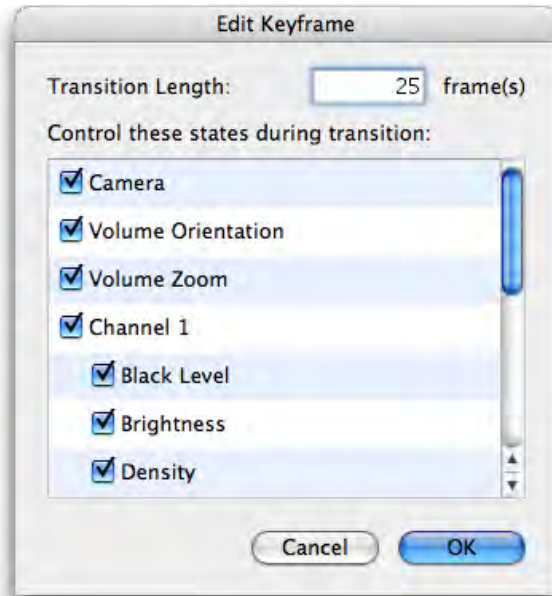

This dialog allows configuration of the length of the keyframe or transition and also selection of the bookmark properties which are used in that transition. It is, therefore, possible to use only the positional information and not the rendering settings stored with a keyframe.

Edit Timepoint Sequence

Double click on a timepoint sequence or select **Edit Timepoint Sequence...** from the Movie menu to access the Edit Timepoint Sequence dialog.

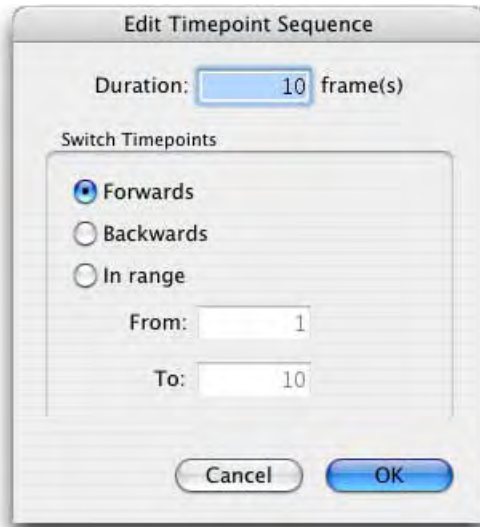

Adjust the number of frames over which the timepoints will be played through, switch between timepoints backwards or forwards.

You can also use this dialog to configure a timepoint sequence to switch between a subset (or range) of timepoints. Additional timepoint sequences may be added to the movie to switch through remaining timepoints.

Resize Movie

Select **Resize Movie...** from the Movie menu to easily change the length of the movie. Movie length may be changed to a percentage of its original length, to a fixed number of frames or to last a known length of time when played at a known frame rate.



Clear Movie

Select **Clear Movie** from the Movie menu to delete all the keyframes and timepoint sequences of a movie.

Save and Restore Movie

Save the movie keyframes by selecting **Save Movie...** from the Movie menu. Give the movie a name and click **Save**. This will store the movie as a preference within the system.

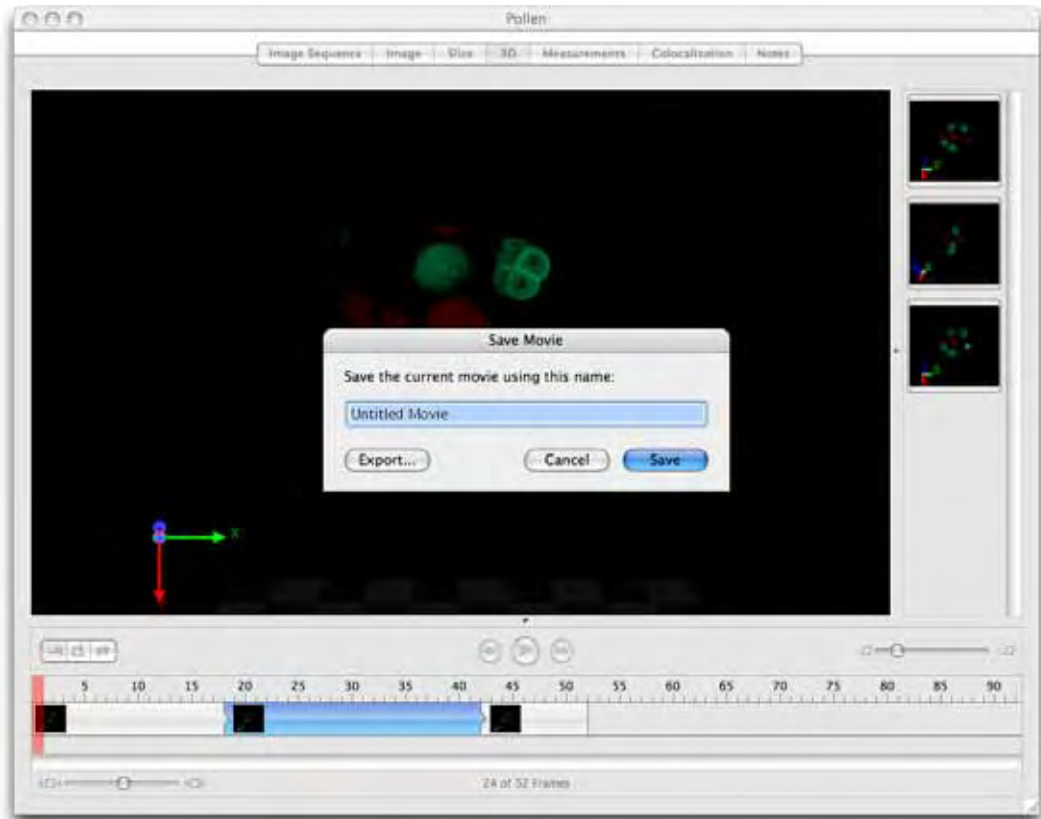

Once saved movies may be used with a data set by viewing the Image View and selecting **Restore Movie...** from the Movie menu.

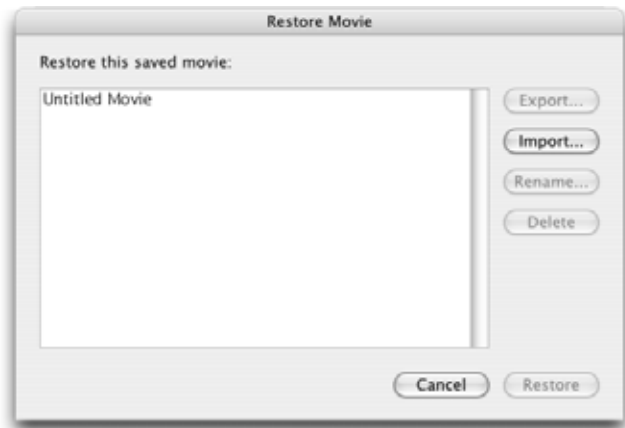

Exporting a Movie

Once a movie is created you may wish to generate the frames of the movie for the current Image View to then be able to export them. Also, it may be relevant to save this movie for future use and for use with different data sets.

Make Movie

Select **Make Movie...** from the Movie menu to create the movie frames and add them to the library.

The Make Movie dialog allows the X and Y pixel dimensions of the movie frames to be set. Choose dimension and click **Make Movie** or accept the last used dimensions by pressing the Return key. A new image sequence will be added to the library. The name is the same as the source data with "Movie" appended.

This image sequence may be exported as a movie file (QuickTime or AVI) by selecting it and choosing **Export...** from the File menu.

Image Sequence View

Image sequences are collections of images arranged by channel and time point. Multi-channel and/or time-resolved data with one or more planes in z is best viewed using an image sequence. Image sequences are created when the data is added to a library or by dragging all the related images onto a new Image Sequence view.

The Image Sequence View shows the brightest point merge of data for each channel and time point as thumbnails. Use the Image Sequence to review the experiment.

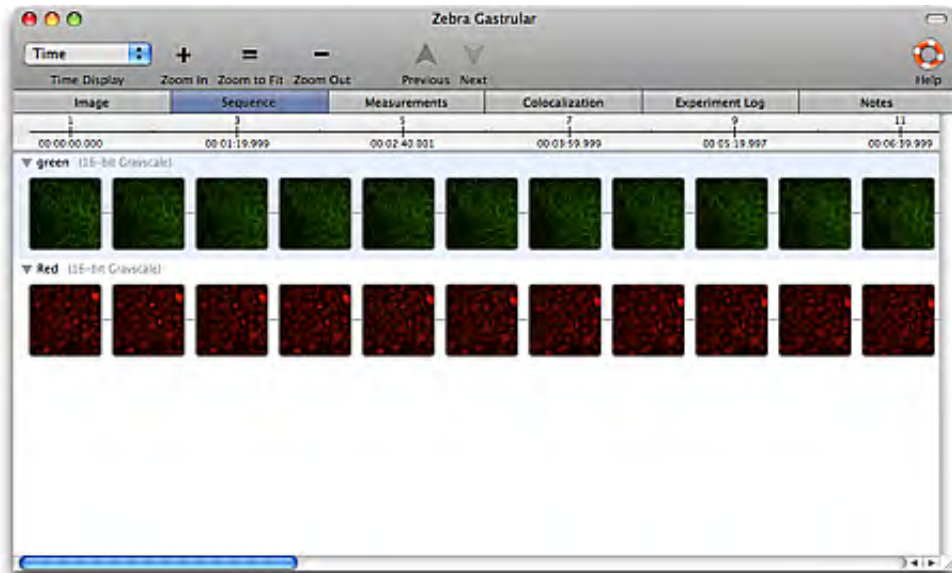

The Image Sequence View may be displayed as Time or Timepoint. In the Time display data images will be shown along the time line according to their spacing in time. In Timepoint mode thumbnails will always be evenly spaced.

Zoom in and out of the view to show detail. When zoomed out more than one timepoint may be represented by a thumbnail. Passing the cursor over the view will 'play' the timepoints represented by that thumbnail.

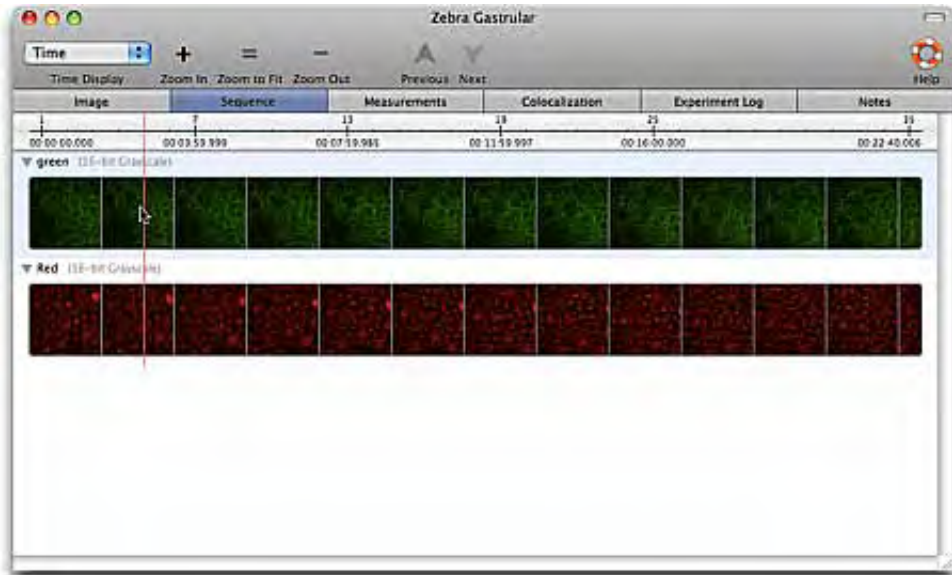

When previewing timepoints in this way double-click will set the timepoint at the cursor to the current timepoint in all other views.

Click anywhere around the thumbnails of a channel to select the channel. Hold down shift to select multiple channels. Selected channels may be processed in the same way in one step by many of the tools available in the Tools menu.

Image Sequence View

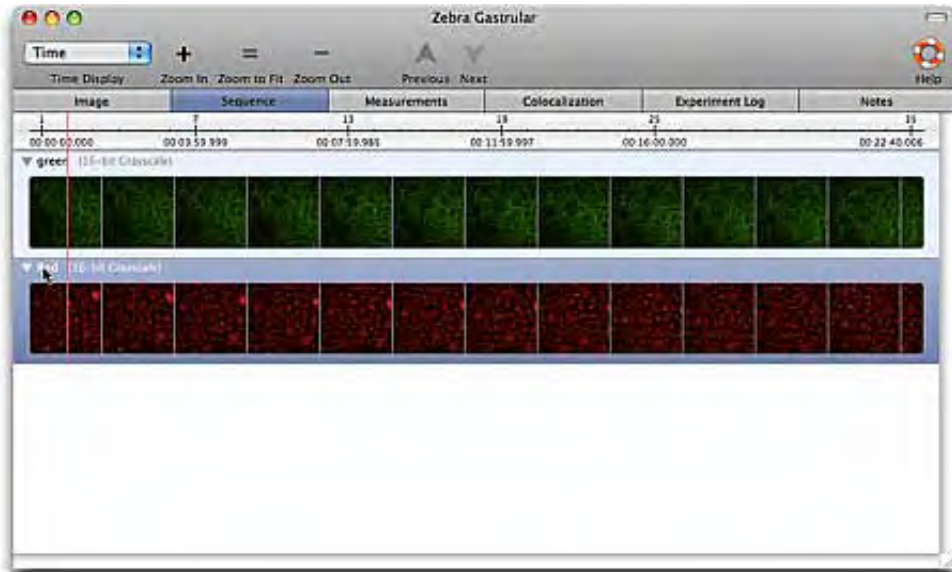

Click and drag horizontally to select timepoints. Adjust the length of the selection using the drag bars. When a subset of timepoints are selected, other views will only show those that are selected. Measurements can be made on just selected timepoints. Selected timepoints may be copied to a new sequence.

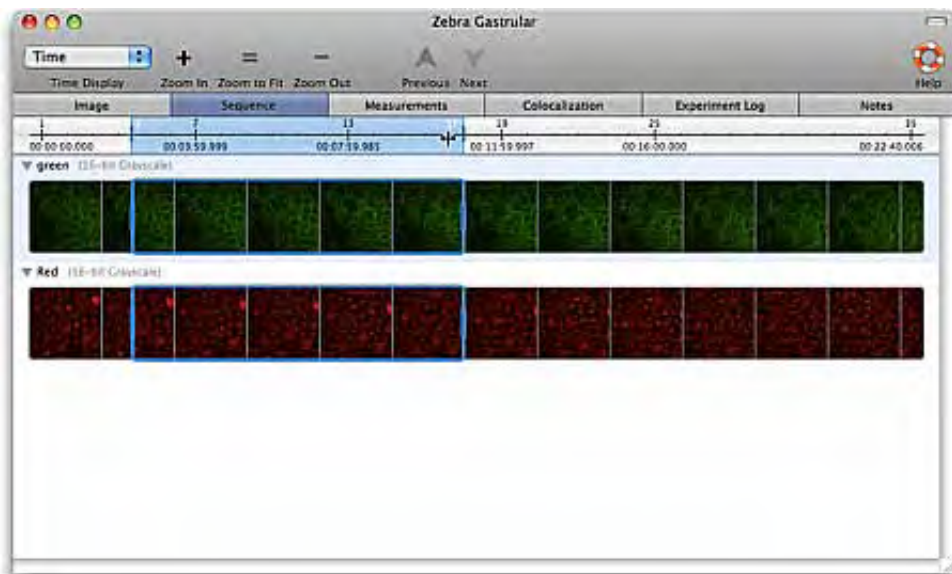

To remove a channel or time point select it and either choose Clear from the Edit menu or use the backspace or delete keys.

Double click on the channel name to rename the channel. Type the new name in place and click away to close the edit field.

Relative and Absolute Times

Thumbnails in the Image Sequence View are labeled with a timepoint number and timestamp. The display of these timestamps can be altered to show:

- n **Absolute Times:** the timestamp given to the volume or the image, or
- n **Relative Times:** when timepoint one is designated as time zero and all other times are displayed relative to that.

Use the appropriate option in the Sequence menu to choose which time is shown.

Merge Channels

This command creates merges the selected channels in an Image Sequence to generate a new merged channel with the same X,Y and Z dimensions as the original. Three different types of merge are available:

- n **Brightest point** – the brightest voxel at each location is taken to make up the merged channel
 - n **Accumulate** – the sum of the intensities of all the voxels at each location is taken to make up the merged channel
 - n **Average** – the average of the intensities at each location makes up the merged channel
1. Select two or more channels in an image sequence and select **Merge Channels** from the Sequence menu.
 2. A new channel will be created in the sequence. The new channel will have the same dimensions as all other channels in the sequence, and the previously selected channels remain unaltered. The new channel will be named "Merged Channel".

Make Reference Channel

This command will generate a single plane reference image from a 3D channel in the data set. The planes in the 3D image are combined using a brightest point merge and displayed at the same z position as one of the planes in the data. The plane of the reference image is selected in the dialog.

1. Select a channel in an image sequence and select **Make Reference Channel...** from the Sequence menu.

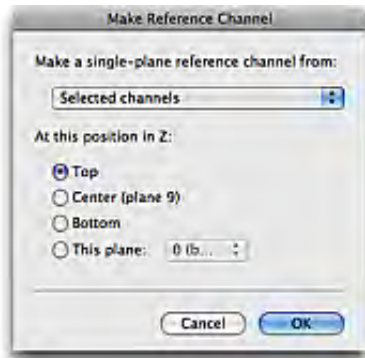

Select the position in z for the reference channel. Available positions are those of the planes of the 3D data. Click OK.

2. A new channel will be created in the sequence. The new channel will be 2D but will have the same XY dimensions as the other channels in the sequence. The new channel will have the text (reference) in the name.

A reference channel can be displayed with 3D data in any of the Image view modes. When making measurements on data reference channels are ignored.

Copy Timepoints to a New Sequence

Create a copy of part of an image sequence by dragging the portion required into the library.

1. Select the timepoints that you wish to copy, using the Timeline View, as described above.
2. Click and hold the mouse button on the column header of one of the selected columns.
3. Drag the selected timepoints out of the sequence and into the library.
4. A new image sequence will be created containing the selected timepoints. The new image sequence is named appropriately to indicate which timepoints were selected.

Resample Timepoints

This command allows the image sequence to be resampled according to a desired frequency of timepoints. This will reduce the number of timepoints in the sequence and therefore its size. A reduced number of timepoints may assist analysis of a time-resolved sequence.

1. Select **Resample Timepoints...** from the Sequence menu.

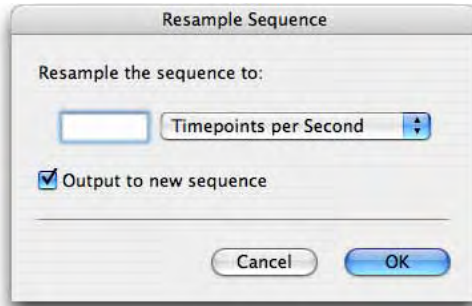

2. Set the new frequency for the sequence.
3. Check **Output to a new sequence** if the results are to be used to create a new image sequence; it will have "(resampled)" appended to the name.
4. Click **OK**.

Note: If timepoints in the image sequence are already at or below the selected frame rate, **Resample Timepoints...** will make no change.

Set Timepoints

It is possible to manually change timestamps for the timepoints of an image sequence to achieve a new, constant rate.

1. Select the Sequence menu, **Set Timepoints**.

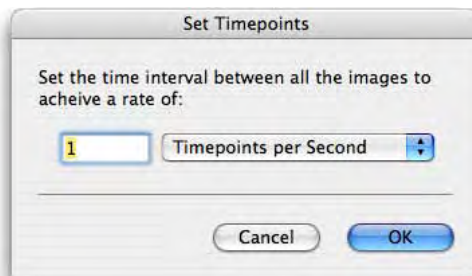

2. Set the new time interval to be used for the entire image sequence.
3. Click **OK**.

Compress Channels

This option allows you to compress channels within image sequences, which will reduce the file size of libraries containing large image sequences.

Note: Only image sequences created in version 2.5 or higher may be compressed.

1. View an image sequence and select the channels to be compressed.
2. Select **Compress Channels** from the Sequence menu.
3. Select the **compression type**, and the **codec** (the encoding to use) for that compression type from the drop-down menus. When using the compression type, QuickTime, the codec drop-down will offer all installed QuickTime codecs.

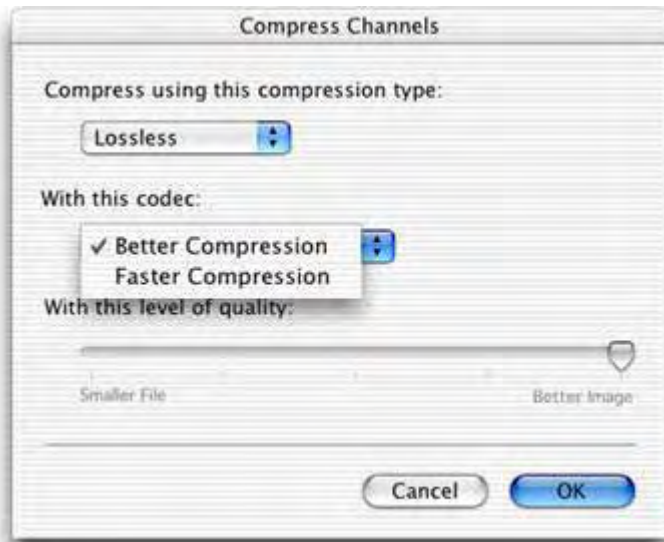

Lossless compression means that no data is lost from the image. The data compressed in this way will remain effectively unaltered. The **Better Compression** codec will result in smaller file sizes, while the **Faster Compression** codec will result in less delay when opening image sequences.

When compressing 8-bit channels, **QuickTime** compression is available. Not all QuickTime codecs are lossless, which means that data may be slightly altered after compression; however, it will usually result in an efficient and fast data compression of large sequences. When using QuickTime compression, use the slider bar on the dialog to choose a compromise between **Smaller File** size or a **Better Image** with less data loss. Using lossy compression on a data set will affect the results of measurements, deconvolution, and other processing, therefore it is not recommended for data that is to be processed further.

4. Click **OK**.

Voxel Spy

The Voxel Spy tool may be used on the XYZ, XY, XZ, YZ, and Extended Focus modes of views which support them. For the voxel under the cursor and for each channel, it shows:

- n The X, Y and Z co-ordinates.
- n The color according to the active look up table.
- n Value(s).



Choose the voxel spy tool from the tool bar. An overlay is shown on the image. This overlay shows the information for the voxel currently under the cursor. Move the cursor over the view to show different voxels in the voxel spy.

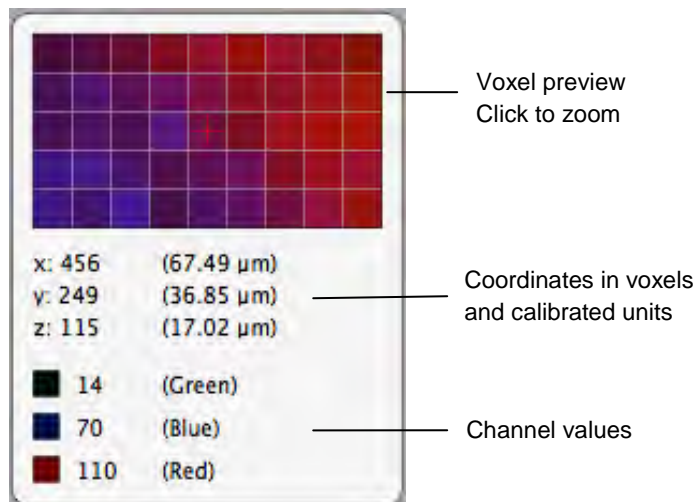

The overlay will show information for the visible channels in the dataset, up to 9 in total. Show or hide channels using the button in the channel controls. Information is not shown for hidden channels. Color images have red, green and blue components and each color channel in a dataset will therefore be shown as 3 lines of information. On an extended focus image the voxel spy shows the brightest intensity through z in that xy location for the channel. Click on the preview area in the overlay to step through different resolutions of the display of the voxel under the cursor and its neighbours. Values shown for voxels are typically intensity values but may represent other properties depending on the source of the channel.

Coordinates are shown in calibrated units according to the properties of the data set, see page 63.

When the voxel spy tool is selected mark locations and display values for up to 3 channels by clicking on the image. The click leaves behind a label for that location. Shift and click to mark

multiple locations for comparison.

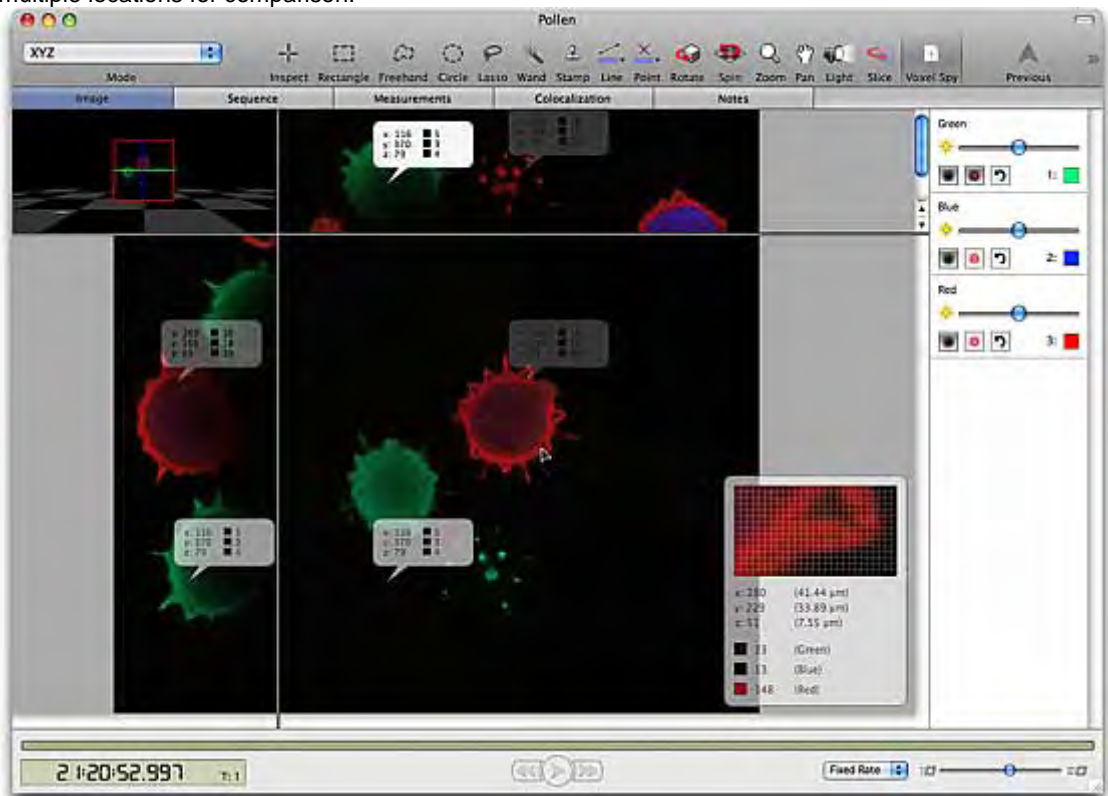

Labels remain in place even when the voxel spy tool is not active and are stored in snapshots made of the image. Select labels by choosing the Voxel Spy tool and clicking on the label. Move labels by clicking and dragging. Select multiple labels with Ctrl-click (Windows) or Apple-click (Mac OS). Selected labels may be moved as a group. Clear all the labels on an image by selecting Edit menu, Clear. Edit menu options only apply to voxel labels when the Voxel Spy tool is selected.

Gallery View

The contents of folders are shown in Gallery views.

Use the Gallery view to see the contents of a folder and select an individual item.



Click once on a folder to show the Gallery view.

Double click on an item to open it in a separate window.

Change the size of the thumbnail displayed here using the options in the Gallery menu.

Show in Library

If you have a single image displayed in the active window or a single image selected in a Gallery View, this command highlights the image in the library structure. From a Gallery View (with no images selected), it highlights the folder or multi-layered file in the library structure.

Notes View

For all items in a library, there is a Notes View. You can add notes to any library item and view or edit the notes at any time. To add or edit notes, just select the Notes View and type in the text. You can use the **Copy** and **Paste** commands from the Edit menu and you can also print the notes, using the **Print** command from the File menu.

Capture Snapshot Command (View-Specific menu)

A view-specific menu is one which activates only when the view is shown. So the image menu is visible in the menu bar when the Image view is active.

Show Data Library menu

Capture Snapshot in the allows you to capture 2D snapshots of even 3D data that you can then print.

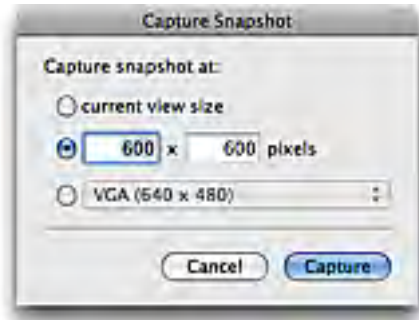

Use the options to create the snapshot suitable for the use in mind.

When used with the Image View, **Capture Snapshot** captures a 2D snapshot of the data.

The **Capture Snapshot** command also captures any scale information, lines or ROIs that are displayed on the active view.

The snapshot will be added to the library and may be opened in the same way as any other image in Volocity. Select the image and File menu, **Export...** to export the snapshot from Volocity.

Volocity Visualization users only

When used with the 3D rendering modes of the Image view, **Capture Snapshot** creates a single 2D image and adds it as a new image to the library. If you want to publish a volume and preserve the 3D effect, use the **Create QTVR Movie...** command from the Tools menu.

Show Data Library menu

You can select an additional item of information, to be shown as a third line of text below the item name.

1. Select **Show Data** from the view-specific menu.
2. Select a property from the drop-down menu.
3. The additional data is displayed.

Sort Items Library menu

You can sort items in a number of different ways.

1. Select **Sort By** from the view-specific menu.
2. Select a property or image brightness or color as the sort criterion.
3. A progress meter is displayed briefly as the application sorts the images and rearranges them.

On Windows use the options **Sort Ascending**, **Sort Descending** and **Sort Recursively** to change the sort behavior. On Mac OS change the sort behavior by using keys to change the menu. Default sort is ascending; hold the Alt key to reverse (descending) sort; hold the Shift key for recursive sort and hold Alt + Shift for reverse recursive sort.

Manipulating Data

Overview

The actions described in this chapter are applicable to both 2D and 3D image data. The commands are ordered alphabetically.

- n Undoing Commands
- n Batch Processing
- n Adopting Items (Actions menu)
- n Applying and Uses of Auto Contrast (Tools menu)
- n Changing Color Depth (Tools menu)
- n Changing Colors (Tools menu)
- n Changing Size (Tools menu)
- n Cloaking Items (Actions menu)
- n Color Balance (Tools menu) (Not available in Volocity LE)
- n Contrast Enhancement (Tools menu) (Not available in Volocity LE)
- n Creating Background Corrections (Actions Menu)
- n Correcting Background (Tools menu)
- n Creating Registration Corrections (Actions menu)
- n Correcting Registration (Tools menu)
- n Cropping Items (Actions menu)
- n Merge Planes (Actions Menu)
- n Removing Noise (Tools menu)
- n Splitting Multi-Colored Items (Actions menu)
- n Splitting Volumes (Tools menu)

Undoing Commands

The Edit menu has an Undo command that allows you to undo the most recent actions. It supports multiple undo actions, starting with the most recent and working backwards in sequence.

Batch Processing

Most image processing and enhancement tasks may be applied to batches of image sequences. Typically, the user will select a series of image sequences in the Library view and the dialog for the process concerned will present a list of unique channel names against which the user selects a process. If channels or items are selected, the option to change selected items will be presented.

Adopting Items (Actions menu)

Permanent changes to data may only be made if that data is saved in the library rather than linked to a source file which remains outside the library. Permanent changes include changing data size, cropping data and many image processing tools. Changing a file so that it is part of the library is called adopting. Adopting increases the library file size.

1. Select the required item(s) in the Library or Gallery window.
2. Select **Adopt Items** from the Actions menu. The application searches for the source item(s). If they are not on the hard disk, it will prompt for the removable medium. It will be unable to adopt an item that was once on the hard disk but has since been deleted or moved.

Applying Auto Contrast (Tools menu)

Auto Contrast automatically sets the black and white points of the display image.

Auto Contrast finds the brightest and darkest pixels or voxels in an item and modifies the lookup table (LUT) so that the brightest point is at the maximum display value, the darkest point is at the minimum display value and all others are adjusted according to a linear best fit. The underlying intensity values within the data are not changed.

1. Select the required item(s). Multiple image sequences can be processed at once.
2. Select **Auto Contrast** from the Tools menu.

Applying Auto Contrast (Tools menu)

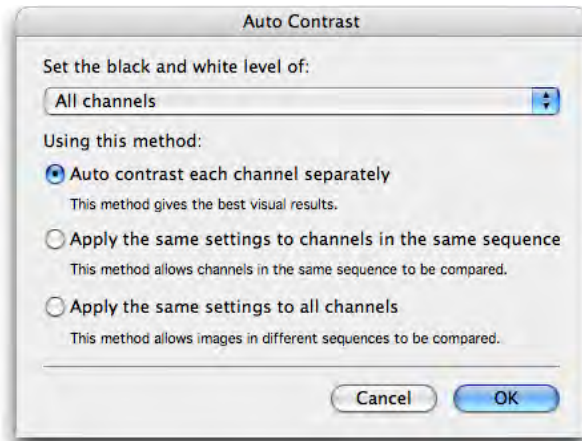

3. The Auto Contrast dialog will offer a list of available channels. Selected channels, if applicable, or all channels may be adjusted.

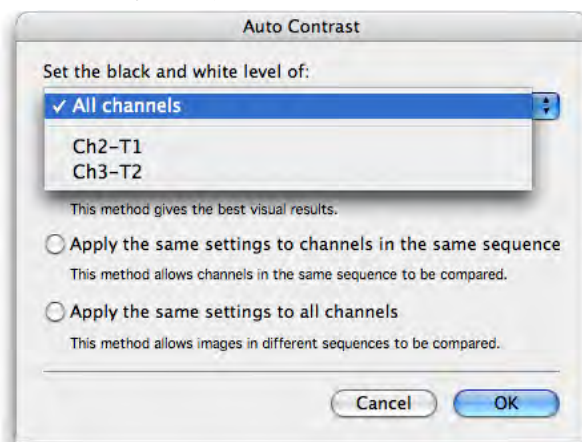

4. Choose the appropriate option depending on how data will be compared. The dialog explains the options.

To manually adjust:

- n Black and white points: use **Contrast Enhancement**, see page 123.
- n Gamma: use **Contrast Enhancement**, see page 123.
- n Red, green and blue contributions in color images: use **Color Balance**, see page 122.

Uses for Auto Contrast

Auto Contrast provides a tool to adjust the LUT on imported data that appears extremely dark or completely black due to a mismatch between LUTs from different software applications.

Auto Contrast can be applied to any item. However, as the contrast achieved depends on the brightest point in each item, the result of applying Auto Contrast to a series of 2D sections (many separate items) will be very different from the result of applying it to a volume (one single item) made from them. In most cases you will want to reapply Auto Contrast after making a volume or image sequence so that the whole data set is treated in the same way.

When working with Auto Contrast, it is important to note that a single voxel that is very much brighter than any other will be enough to set the brightest level. This can lead to Auto Contrast causing no apparent change to data.

Changing Color Depth (Tools menu)

Changing color depth changes the nature of the data and information will be lost. It is not a common image processing operation.

1. Select the required item(s.) Multiple image sequences may be processed at once, simply select them in the library. Select **Change Color Depth...** from the Tools menu.
2. Click on the drop-down menu and select the required color depth.



3. Click on **Change**.

Changing Colors (Tools menu)

This command allows you to apply a different color lookup table to images, it does not change any underlying data. Multiple items may be changed in a batch by selecting them all in the library view.

1. Select the required item(s) and select **Change Colors...** from the Tools menu.

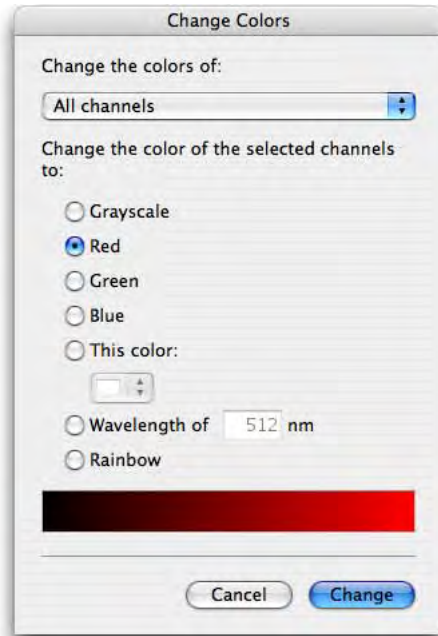

2. Select the channel or channels to change
3. Click on the appropriate grayscale or RGB color. You can also click on **This color** and select a color from the drop-down menu, enter a wavelength value or apply a Rainbow LUT.
4. Click on **Change**.

Changing Size (Tools menu)

Use **Change Size** to scale data, changing the spatial resolution of the data and preserving the field of view.

With 3D image data you can change the size of a volume in all axes, which uses less memory and saves time for some processes.

Where resolution of data is important, for example when performing measurements or restoration it is preferable to preserve resolution and crop data instead, using the **Crop to Selection** command in the Actions menu.

To scale data when making single volumes see page 54.

The following example illustrates how to change the size of 3D items (the process is the same for 2D items, but step 3 is not required).

1. Select the required item(s) and select **Change Size...** from the Tools menu.

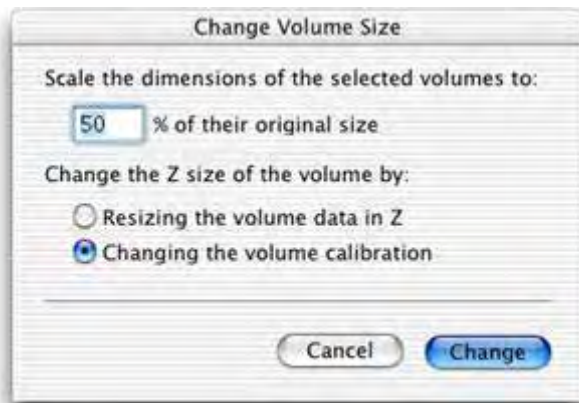

2. Enter a scaling factor.
3. For 3D images only, enter a scaling value as a percentage. The X and Y dimensions are scaled automatically, but you can choose how you want to change the Z size of the volume.
4. Select **Resizing the volume in Z** to change the amount of data in the volume by discarding some of the z slice data. This command changes the number of frames in z.
5. If the volume is short of z data, select **Changing the Z calibration** to retain all of the data but recalibrate the volume in z. This command does not change the data. It maintains calibration, which is taken into account in other processes.
6. Click on **Change**.

Cloaking Items (Actions menu)

Temporarily hide an image to prevent inclusion in an image sequence by cloaking it.

1. Select the item(s) that you wish to hide in the Library.
2. Select **Cloak** from the Actions menu.
3. To Uncloak the item select it again and choose **UnCloak** from the Actions menu.

Color Balance (Tools menu) (Not Available in Volocity LE)

Color Balance is a dialog that allows the user to adjust the contributions of red, green and blue in a color image.

1. Select the item(s) to be adjusted in the library.
2. Select **Color Balance...** from the Tools menu.

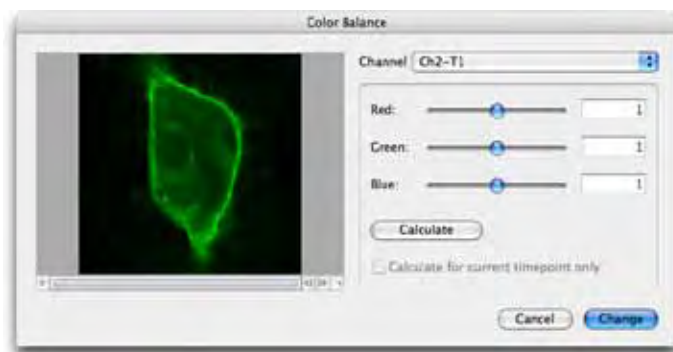

- n If multiple 2D images are selected, the preview shows the first in the list; the same contrast enhancement settings are applied to all images.
 - n If multiple 3D volumes are selected, the preview shows a brightest point merge of the first in the list; the same contrast enhancement settings are applied to all images.
 - n If multiple image sequences are selected, the preview shows the first of the selected sequences. Only one channel at a time is previewed as a brightest point merge. The drop-down at the top of the screen shows a list of the unique channel names detected in the selected sequences. Controls under the preview allow navigation to different timepoints.
4. Use the sliders to increase or decrease the contribution of the colors to the final image.
 5. Adjust one channel at a time; clicking **Apply** will change the selected channel but keep the dialog open allowing more changes to be made. Only one channel at a time may be enhanced but channels with the same name in multiple sequences may be enhanced in a batch.
 6. Click **Change** to apply the last change and close the dialog

Contrast Enhancement (Tools menu) (Not available in Volocity LE)

Contrast Enhancement is a dialog that allows the user to manually set the black and white points of the display lookup table for an image, thus changing the contrast. It also allows gamma adjustment which will set a non-linear distribution of that lookup table between the black and white points.

1. Select the required item(s) in the library. If working with an image sequence, select the channel to be enhanced.
2. Select **Contrast Enhancement...** from the Tools menu.

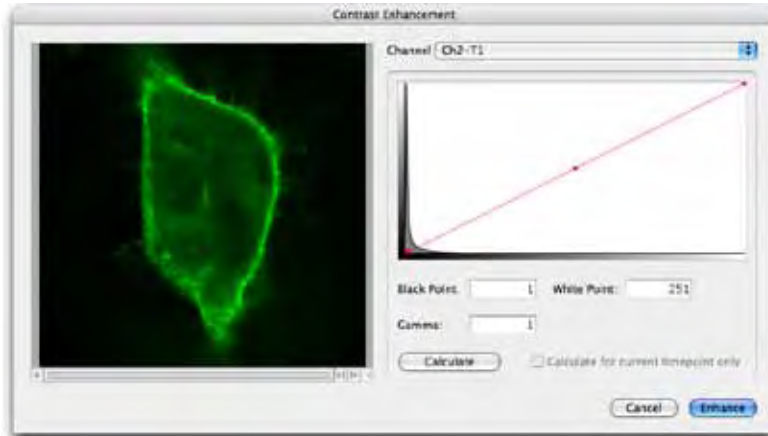

- n If multiple 2D images are selected, the preview shows the first in the list; the same contrast enhancement settings are applied to all images.
- n If multiple 3D volumes are selected, the preview shows a brightest point merge of the first in the list; the same contrast enhancement settings are applied to all images.
- n If multiple image sequences are selected, the preview shows a brightest point merge of the first channel in the first sequence. A drop-down at the top of the screen shows a list of unique channel names detected in the selected sequences. Controls under the preview allow navigation to different timepoints, if applicable.

Contrast Enhancement (Tools menu) (Not available in Volocity LE)

The red line across the histogram shows the current relationship between the input intensity values (X-axis) and the output LUT (Y-axis).

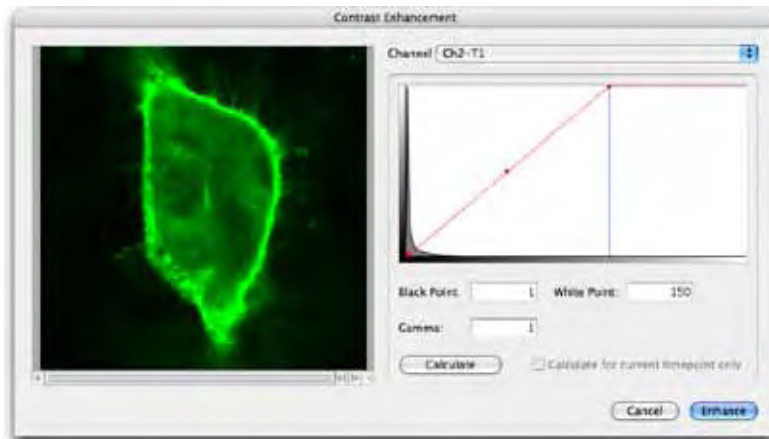

Use the control points (red squares on the red line) to move the black, white and gamma points.

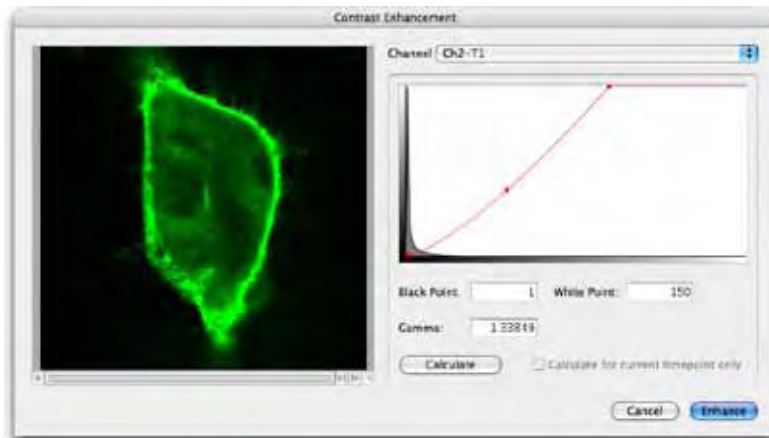

- n Change the Y-axis of the histogram to see detail more clearly, cycling through four possible resolutions; linear, log, base 10 and base 100. To do this:

WINDOWS: Ctrl-click in the histogram area

Mac: Alt-click in the histogram area

3. Click **Apply** to enhance all the channels with the selected name and leave the dialog open so that other channels may be enhanced.

Calculate black and white points based on the darkest and brightest intensities in the data set by clicking on the **Calculate** button. For time series data choose to set these using just the current timepoint.

Note: The controls on the Contrast Enhancement dialog cannot be used on data sets that have been colored with rainbow colors, see page 120.

4. Once you are satisfied with the adjustments in the preview area, click on **Enhance**.

To adjust contribution of red, green and blue in a color image use Color Balance, see page 122.

Background Corrections

In order to perform accurate analysis of your images or to improve their appearance, you may need to perform **Background correction**. Background corrections include dark current correction, background subtraction, shading correction or offset application. Bright or dark reference images may be required for your correction.

Shading

Shading defects can be introduced into images by poorly aligned light sources, stray light and dirt in the light path.

Shading artefacts are corrected by including division of a bright reference image in your background correction. A suitable bright reference image for fluorescence images can be acquired from an illuminated, uniformly fluorescent sample. A bright reference image for bright field images can be acquired from a blank field (with no specimen present), which has been slightly defocused.

Dark Current, DC Offset.

Ideally, acquiring images from a digital camera in complete darkness would result in images with gray levels close to zero. However, this is not the case. A combination of factors including dark current and DC offset will result in gray levels 10s or 100s of levels from zero. These offset values are present in all images acquired with digital cameras.

This is of no consequence for purely observational experiments when only the appearance, position or size of structures is of interest. However, when the intensity of objects is of interest these factors introduce error to all measurements made. The margin of error is small compared to the intensity of very bright objects, however, it becomes increasingly significant the fainter objects of interest become.

A background correction that subtracts a “dark reference” image from all images corrects this problem, increasing the accuracy of all intensity measurements made. “Dark reference” images are acquired by blocking all light from the camera and acquiring an image. Ideally, the exposure time of

Creating Background Corrections (Actions Menu)

the “dark reference” should be the same as the exposure time of the experimental images to be corrected.

A background correction that subtracts a fixed value from all images could also be used to correct this problem, but this is likely to be less accurate than using a dark reference image.

Background (fluorescence)

Further error can be introduced into intensity measurements by the presence of background fluorescence in a sample. This can be corrected by building a background correction that subtracts a “dark reference” image from all images. In this case the dark reference should be acquired from an illuminated area of your sample in an area in which no cells (or debris) are present. Again, the exposure time of the “dark reference” should match the exposure time of the experimental images to be corrected. A “dark reference” image acquired under these circumstances would correct background fluorescence in addition to dark current and DC offset.

Defects that can be corrected are summarized in the table below:

Defect	Correction	Image Required for correction
Shading (fluorescence)	Division with a bright reference	Illuminated uniformly fluorescent slide
Shading (bright field)	Division with a bright reference	Slightly-defocused bright field image (with no specimen present)
Dark current, DC offset	Subtraction of dark reference	Image acquired with light to camera blocked
Dark current, DC offset	Subtraction of a fixed value from every pixel	None, set a negative offset in the correction (this correction is less accurate than subtraction of a dark reference image)
Background (fluorescence)	Subtraction of a background image as a dark reference	Illuminated sample with no cells in the field of view

Creating Background Corrections (Actions Menu)

You should acquire or add bright and/or dark reference images to your library before you build background corrections. Bright and dark reference images should be the same dimensions in X and Y, and the same depth as your images to be corrected.

1. Select **Create New** from the **Actions** menu.
2. Select **Background Correction...** to create a new background correction item in the library.

7. The Create Background Correction dialog opens.

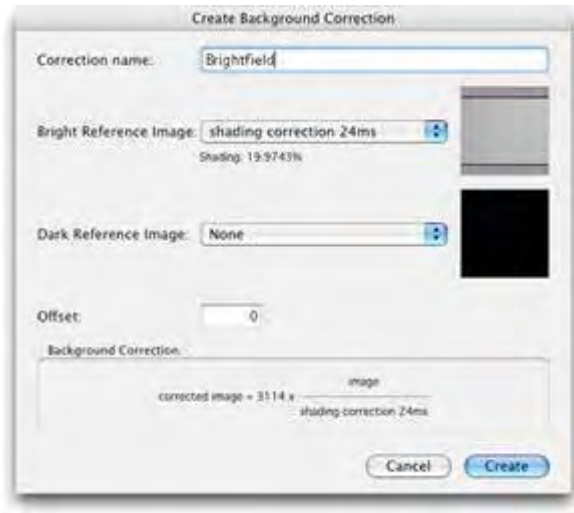

You can use the dialog to create a variety of corrections. As you build your correction, it is summarized at the bottom of the dialog. When you first open the dialog the summary reads “corrected image=image” to reflect that you have yet to specify any corrections.

You may apply as many or as few elements of the equation as you wish in your corrections, depending on what you wish to correct for and how accurately you wish to do so.

Volocity uses the following equation when building background corrections:-

$$\text{Corrected Image} = \text{Scaling Factor} \times ((\text{Raw Image} - \text{Dark Reference} + \text{Offset}) / (\text{Bright Reference} - \text{Dark Reference}))$$

Bright Reference Images

If you wish to divide your raw images by a bright reference image, select a bright reference image from the drop-down menu. All of the images in the library will be displayed in the list. The degree of shading in the bright reference is displayed in the dialog using the formula:

$$\text{Shading} = (\text{Intensity}_{\text{max}} - \text{Intensity}_{\text{min}} / \text{Intensity}_{\text{max}}) \times 100\%$$

Creating Background Corrections (Actions Menu)

If you select a bright reference image, your corrected image will be multiplied by a scaling factor to bring its gray levels into a convenient range. The scaling factor is the brightest pixel value in the bright reference image (after subtraction of the dark reference image, if selected).

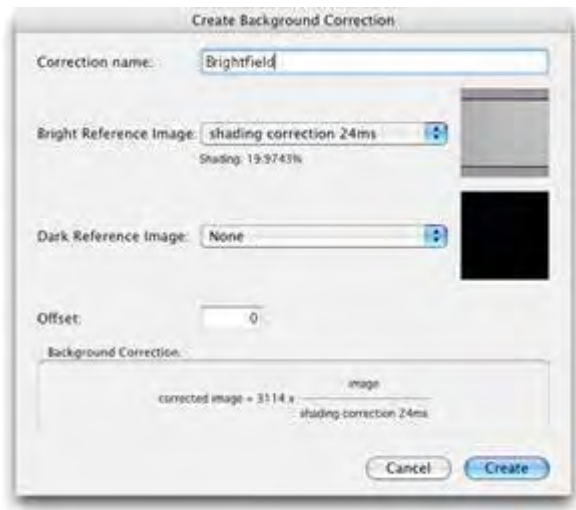

Dark Reference Images

To subtract a dark reference image from your raw images, and bright reference images if you have selected one, select an image from the dark reference drop-down menu. All of the images in the library are listed in the drop-down menu.

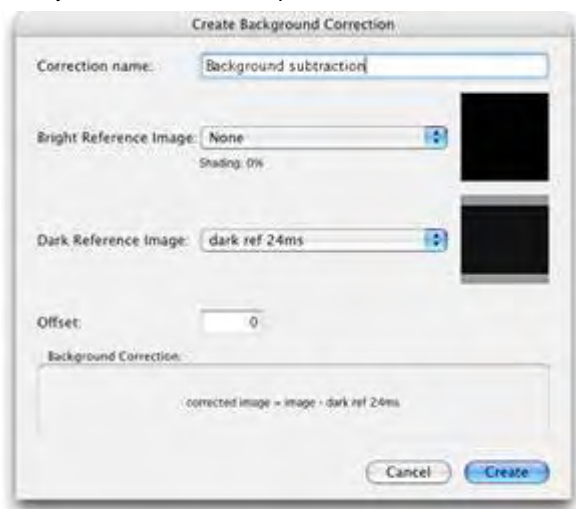

Offsets

To apply an offset to your images, enter a positive or negative value into the offset field of the dialog. Positive values will be added to raw images, negative values will be subtracted.

When you have built a satisfactory background correction, select **Create**. A new background correction item is added to the library.



Background correction items can be exported from libraries as library clippings and imported into other libraries.

Inspecting Background Corrections

Select a background correction item in the library to inspect it. The background correction will open and you can review the names and thumbnails of images that were selected as either bright or dark reference images, as well as a summary of the background correction that will be applied.

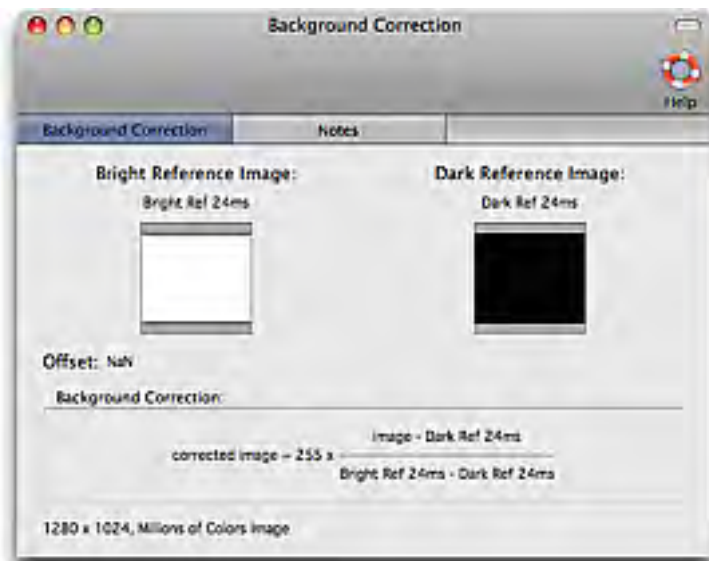

Correcting Background (Tools menu)

In order to perform accurate analysis of your images or to improve their appearance, you may need to perform **Background correction**. Background corrections include dark current correction, background subtraction, shading correction or offset application. Bright or dark reference images may be required for your correction.

Correcting Background (Tools menu)

For further information on background correction and the images required please see page 125.

To use the **Correct Background...** command the library must contain appropriate background correction items (see page 125).

1. Select any images or image sequences that you wish to background correct.
2. Select **Correct Background...** from the Tools menu. The **Background Correction** dialog opens.

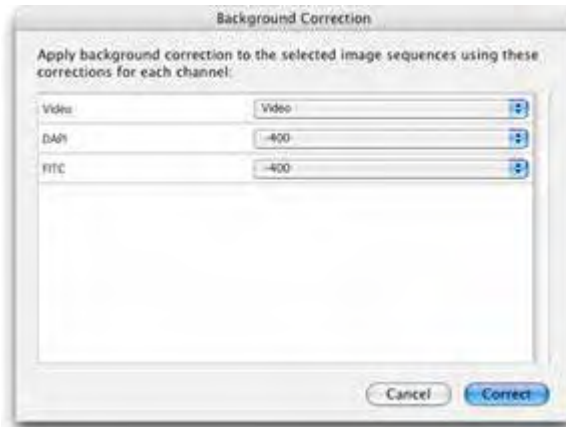

3. Velocity will attempt to match the names of the background correction items in your library to the names of the channels in your selected images or image sequences. If you have many correction items in your library, you may need to manually select the background correction by clicking on the drop-down menu for each channel and making a more appropriate selection.
4. Click **Correct**.

Background corrections can be applied to 3D image sequences in the same way that they are applied to 2D datasets. The same background correction will be applied to each plane of your volume.

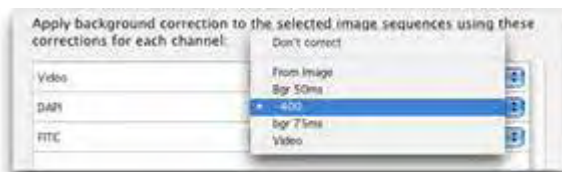

- n For image sequences: Velocity will create new background corrected channels in image sequences in which your background corrections have been applied.
- n For images: background corrected images will be placed beneath the original images in the library.

Creating Registration Corrections (Actions menu)

“Registration Corrections” are items that record the degree by which channels need to be moved in X,Y and Z in order to bring them into perfect register. Once Registration Corrections have been generated they can be applied to image sequences indefinitely, provided that the degree of shift between channels remains constant.

We recommend that you first acquire an image sequence of a fluorescent bead set from which registration shifts can be accurately calculated. You should acquire a multi-channel image sequence and ensure that you acquire every channel and every magnification with which you intend to work in your experiments. If you intend to do 3D work, you should acquire 3D image sequences of the beads so that you can detect and correct any registration problems in the Z axis.

1. Select the image sequence on which you wish to base your corrections in the library.
2. Select **Create New** from the **Actions** menu.
3. Select **Registration Correction...**

The Create Registration Correction dialog opens.

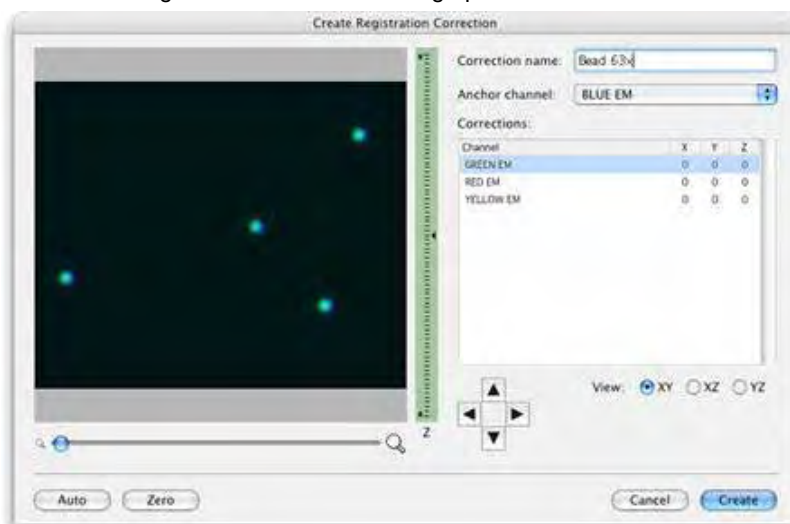

4. Enter a name for your registration correction.
5. Velocity will automatically select an anchor channel, this is the channel relative to which the remaining channels will be shifted. If you wish to use another channel as the anchor, select one from the drop-down menu.
6. To manually create registration corrections go to step 7. To automatically create registration corrections go to step 14.

Manual Creation of Registration Corrections

7. Select one of the remaining channels from the list to see its position relative to the anchor channel.
8. Change the **View** displayed in the preview from **XY** to **XZ** or **YZ** by selecting the appropriate radio button, and change the magnification of the preview by dragging the magnification slider.
9. Change the position of the currently displayed plane by either dragging the current plane arrow on the depth control or by clicking anywhere on the depth control.
10. Move the currently selected channel relative to the anchor channel by clicking on the four direction arrows, which will move the selected channel relative to the anchor channel. Move the channel so that it is in perfect register with the anchor channel in the X, Y and Z planes.
11. When you are satisfied that your channel is in perfect register with the anchor, select your next channel and repeat the process.
12. Ensure that all your channels are correctly registered with the anchor. Ensure that you have checked all channels and all views. Registration Corrections are likely to be applied to many image sequences so accuracy at this stage is essential.
13. Click **Create**.

Automated Creation of Registration Corrections

14. To make Volocity attempt to automatically place each channel in register with the anchor channel, click **Auto**.
15. A progress bar is displayed as Volocity calculates the degree of shift between each of the channels.



16. Volocity displays the number of pixels by which each channel has been shifted in X, Y and Z in order to place it in perfect register with the anchor channel.

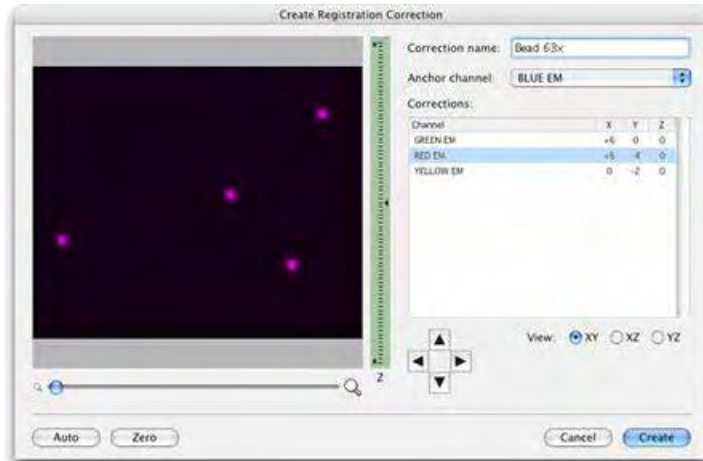

17. To check the correction of a channel, select the channel from the list. Volocity will display only that channel and the anchor channel in the preview.
18. Manually edit the position of a channel relative to the anchor channel by clicking on the four direction arrows.
19. When you are satisfied that the corrections are accurate, click **Create**.

Registration correction items can be exported from libraries as library clippings and imported to new libraries, so you should not have to repeat the process of generating registration corrections.

Inspecting Registration Corrections

Volocity adds registration corrections to the library. Corrections made at the same time are placed in a folder. The folder and the corrections have the name that was entered in the Create Registration dialog.



Correcting Registration (Tools menu)

You can inspect registration corrections by double clicking on the associated item in the library. You can check the anchor channel and the relative pixel shift associated with each correction.

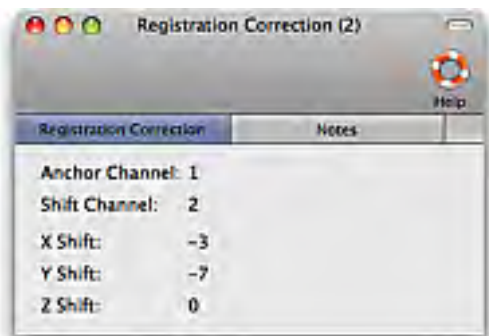

Correcting Registration (Tools menu)

When working with multi-channel image sequences you may find that channels are not always aligned with each other in perfect register. Channels may be shifted in the X, Y, or Z (or a combination of) planes relative to each other. Often this problem can be corrected by making improvements to your acquisition hardware such as purchasing shift-free fluorescence filter sets. Should this prove impractical you can use Volocity to correct registration problems.

To use the **Correct Registration...** command the library must contain the appropriate registration corrections. See page 131.

To apply registration corrections to image sequences:

1. Select the relevant image sequences in the library.
2. Select **Correct Registration...** from the Tools menu.
3. The registration correction dialog will open.

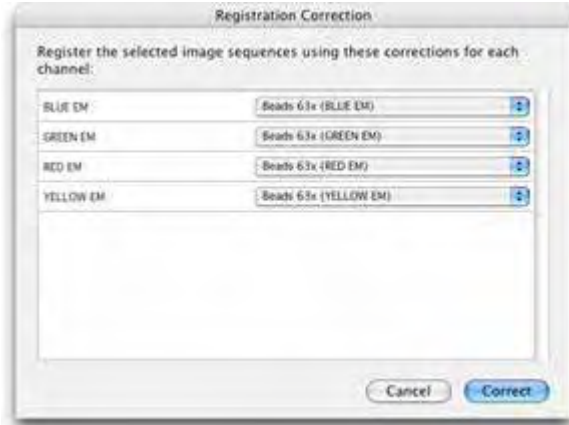

4. Volocity will attempt to match the names of the registration correction items in your library to the names of the channels in your selected image sequences. If you have many correction items in your library you may need to manually select the registration correction by clicking on the drop-down menu for each channel and making a more appropriate selection.

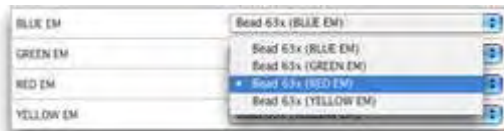

5. We recommend that you avoid mixing corrections that were generated at different times. Volocity will warn you if you choose to do this.
6. When you are satisfied that each of your channels is paired with the appropriate correction item, click **Correct**.
7. Volocity will create new image sequences in which your registration corrections have been applied. Each sequence will have the original name with the suffix (registration corrected).

Any areas in registration corrected sequences for which Volocity does not have data from all the channels in the sequence are cropped from the sequence, so registration corrected image sequences always have slightly smaller dimensions than the originals.

Correcting Photobleaching (Tools menu)

The Volocity photobleaching correction tool corrects for photobleaching by applying correction factors to images to maintain intensities that are reduced by photobleaching during the course of an image sequence.

There are two methods of applying photobleaching correction. Apply whichever is appropriate for your experiment.

- n Based on a region of interest. To apply a correction based on a region of interest you must have your image sequence open in the Image view. Select an ROI and then select **Correct Photobleaching...** from the Tools menu. Make sure that you select the appropriate channel for correction.

The mean intensity of the ROI in the first timepoint is determined, ignoring black voxels and saturated voxels. Every voxel in every other timepoint is then multiplied by the correction factor necessary to maintain the same mean intensity within the ROI across all timepoints. Each channel is handled separately with the relevant correction factors.

- n Based on the whole image. Select **Correct Photobleaching...** from the Tools menu. Make sure that you select the appropriate channel for correction.

The mean intensity of the channel in the first timepoint is determined, ignoring black voxels and saturated voxels. Every voxel in every other timepoint is then multiplied by the correction factor necessary to maintain the same mean intensity across all timepoints.

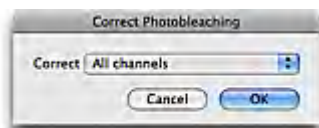

Photobleaching correction based on the whole image supports batch processing. To batch process several images sequences, select them in your library before selecting **Correct Photobleaching...** from the Tools menu.

Cropping Items (Actions menu)

Cropping data to a selection reduces the physical size and therefore the file size of an item in the library. Cropping a dataset means information outside the selection is lost but the spatial resolution of the remaining data remains the same.

1. In the Image window, use one of the selection tools to outline the ROI (region of interest). See page 87 for more information about using Selection tools
2. Select **Crop to Selection** from the Actions menu.

In a 2D Image, this crops to the selected area. In a Movie window, this crops all frames to the selected area. In a 3D Image, this crops all Z slices. In an Image Sequence, this crops the XY dimensions of all Z slices in all channels in all timepoints.

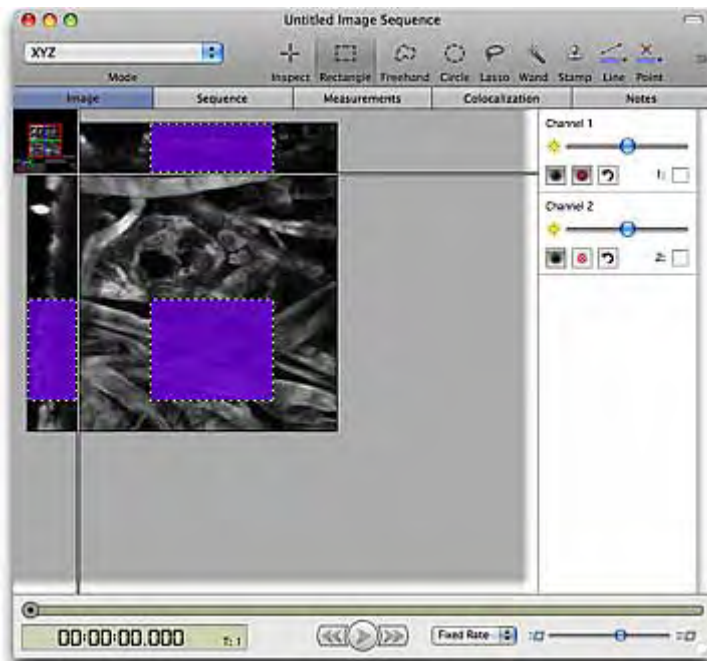

Crop to Selection will create a new item in the library unless the corresponding key combination is used. Hold down the Alt key (Mac OS) or the Ctrl key (Windows) to change the Actions menu item to **Crop to Selection in Place**.

Change resolution and reduce the file size of data sets while preserving the field of view using the Change size command (see page 121).

Make volumes of the required resolution using scale data when making single volumes (see page 54).

Illumination Correction (Tools menu)

Minor anomalies in excitation light intensity over time, such as lamp flicker, can lead to inconsistently bright or dark layers through a volume. The flicker may not be apparent during inspection of the raw data but may be more noticeable if data is visualised in 3D or processed using restoration tools.

Select the required image(s) or image sequence(s) and select **Correct Illumination** from the Tools menu. The process is applied immediately, there is no dialog shown.

Correct Illumination operates within each individual volume and bases any intensity correction solely on the trends shown within that volume. It does not normalize time resolved data to account for bleaching and cannot correct severe problems with lighting during the experiment. Ideally, lamp flicker should be avoided by using a stable light source.

Merge Planes (Actions Menu)

Merging planes creates a brightest point merge of 3-dimensional data to create a 2-dimensional image. It effects a permanent change to the data set by creating a copy of the original data.

It may be used to reduce data size or simplify movie playback.

1. Select the item(s) which are to be merged from 3-dimensional to 2-dimensional.
2. Select **Merge Planes** from the Actions menu.
3. A new item is created in the library. It has the same name as the old item with “(merged)” appended. The actual number of channels and timepoints in the image is not altered, but the image at each timepoint will be two-dimensional.

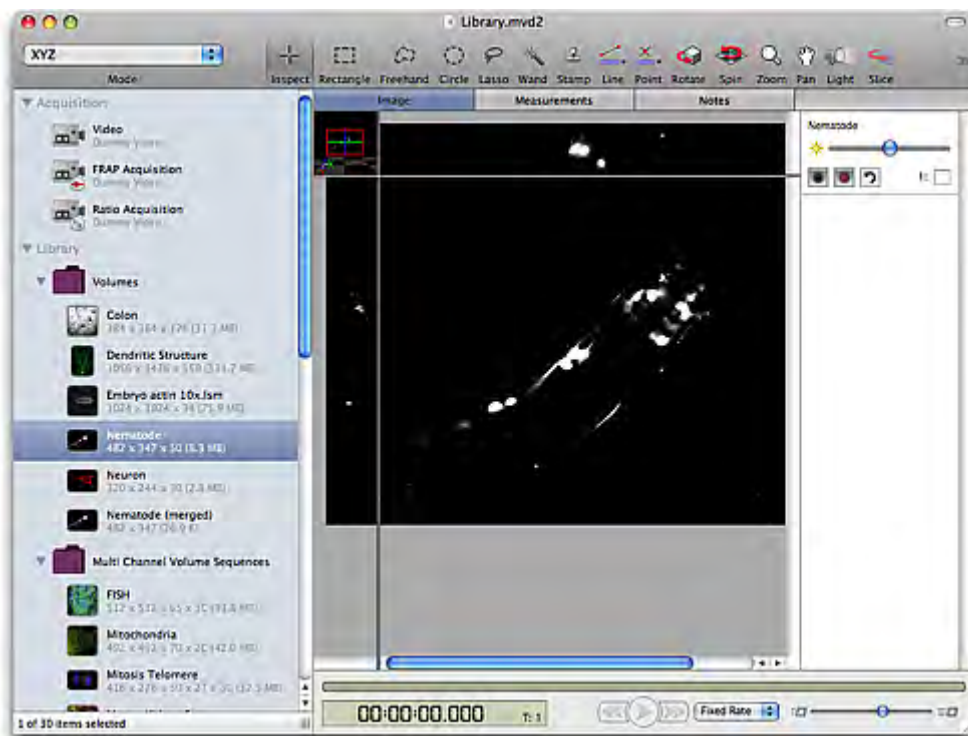

Note: Unlike the Extended Focus view described on page **Error! Bookmark not defined.**, which creates a brightest-point merge of all the Z-slices in a volume, **Merge Planes** does actually create a two-dimensional image, and any selections and measurements performed on this image will be two-dimensional.

Removing Noise (Tools menu)

The application provides a number of median filters that can be applied to remove noise from an image. These filters range from fine to very coarse offering an increasing size of filter matrix and degree of filtering.

1. Select the required item(s) and select **Remove Noise...** from the Tools menu. Multiple image sequences may be selected for processing at once.

Splitting Multi-Colored Items (Actions menu)

2. Select All Channels or the channel name to be adjusted. Click on the drop-down menu and select the required filter.

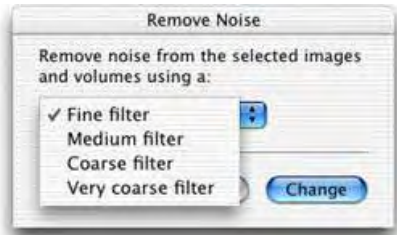

Fine = 3x3(x3)

Medium = 5x5(x5)

Coarse = 7x7(x7)

Very coarse = 9x9(x9)

3. Click on **Change**. This command may take some time to complete if you have selected a large number of items.

Splitting Multi-Colored Items (Actions menu)

If you have a multi-colored item, you can split it into its three channels. Select the required item(s) and select **Split RGB** from the Actions menu.

Splitting Volumes (Tools menu)

You can split a volume from the library or from any of the Image views. This converts the volume into a layered format to produce a stack of two-dimensional images.

1. Select the volume(s) and select **Split Volumes** from the Tools menu.
2. At the prompt choose how you want the volume to be split. You can separate the images into folders where channels and timepoints will be separated, or put all images into a single folder, in which case you will also need to specify **Order by** criteria from the drop-down menu.



3. Volocity creates new folder item(s) in the library containing stack(s) of 2D images.

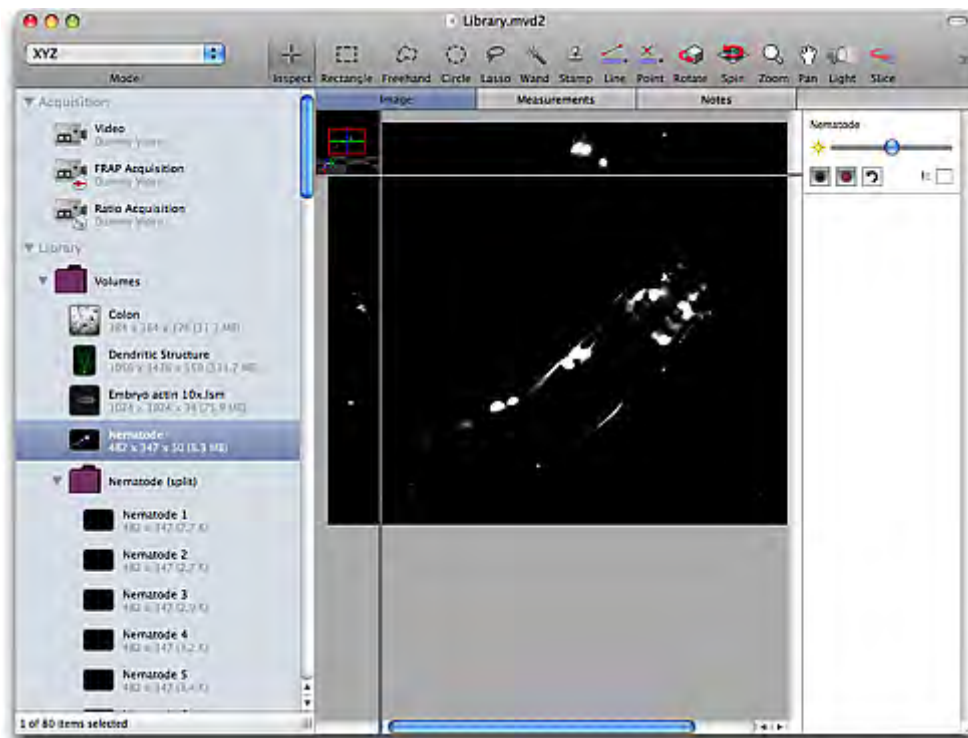

Splice Sequences (Actions menu)

Splice Sequences will add sequences together to make one sequence where the number of timepoints is the sum of all the timepoints in all the selected sequences. Sequences to be spliced must have the same X, Y, and Z dimensions. Sequences will keep their original timestamps where possible. Sequences of different color depths will be changed to have the color depth of the first selected sequence.

Tile Sequences (Actions menu)

Tile sequence will automatically arrange the selected sequences in a grid in a new sequence. Sequences need not be of the same dimensions in X, Y, Z or time but the new sequence will be padded with black space where necessary. If the original sequences are of different depths the resultant tiled sequence will be millions of colors. The resultant, tiled sequence is given the timestamps of the first sequence in the selection.

Printing and Exporting Data

Overview

This chapter describes how to:

- n Print from the application.
- n Export items.

Printing from the Application (File menu)

You can print the contents of the active window. This may be the Library View, a Single Image View or a Gallery View, as appropriate. Although print commands are available from the 3D Views, they are not useful for publishing volumes—you can use the **Capture Snapshot** command from the Image menu to create 2D images of the 3D View that you can print (see page 113).

The dialogs for print and page setup commands vary according to the type of printer that you are using.

1. Click with the cursor in the window that you want to print.
2. Use the view-specific menu options, as appropriate to control how the image appears.
3. Select **Print** from the File menu, or from the Print Preview window, if that is displayed.

Print Preview

If you want to check the result before printing, select **Print Preview** from the File menu. You can usually access the Page Setup and Print commands directly from the preview.

Page/Print Setup

1. Click on **Page Setup...** in the File menu (Mac). Click on **Print Setup...** in the File menu (WINDOWS).
2. The Setup dialog varies, depending upon which printer you are using. Amend the settings, as appropriate, and click on **OK**.

Exporting Items (File menu)

The Export command allows you to export an item from the library as any of a variety of formats. You can also use it to copy files between libraries.

1. Select the required items in the library or switch to the appropriate view.

2. Select **Export...** from the File menu.



3. Change the file name, if required, and select a folder for the exported file(s).
4. Select the **Format** from the pop up. Some file formats have an **Options...** button which allows configuration of the setting relevant to that format. If multiple items are selected for export the Export file dialog will show a **Naming...** button allowing you to define how the individual files will be named. Set the options, as appropriate, and click **OK**.



5. Click on **Export**.

The export options depend on the view open and the product being used:

- n Export single images to create single images in formats such as TIFF or JPEG. Select multiple single images to export all the images as the same format in one step.
- n Exporting a folder of images will make a multi-layered item such as a QuickTime movie or a multilayered TIFF.
- n Export volumes and image sequences to export the item as a multi-layered file: Openlab LIFF, Openlab Raw, QuickTime movie or TIFF. The order of layers in the exported file will be z-slices then channels then time.
- n When working with an image sequence which contains time resolved data, selecting export from an Image (Extended Focus) or 3D View, offers the ability to export the view as a movie which will make a simple movie of that view stepping through timepoints.
- n Quantitation: Export Measurements as tab delimited or comma separated text.
- n Use the library clipping format to move any library item easily between libraries.

Volocity LE does not allow the creation of QuickTime or AVI movies.

It is also possible to export settings from many parts of the software. Users of Volocity Acquisition are able to export acquisition protocols. Users of Volocity Quantitation are able to export measurement protocols. Users of Volocity Visualization are able to export movies. In the dialog where these settings are saved there will be an **Export...** option allowing users to save their settings.

For the latest information on supported file formats, please look at the Release Notes on Improvion's Support web pages at <http://www.improvision.com>.

Export as AVI Movie for Windows Only (Not available in Volocity LE)

Windows users have an additional movie format available for export, the AVI format.

1. Select a folder of images in the Library view.
2. Select **Export...** from the File menu.
3. Enter the file name and select a location for the completed movie.
4. Choose **AVI Movie** from the **Format** drop-down and click **Export**.

Export as QuickTime Movie (Not available in Volocity LE)

This option allows you to export a QuickTime movie with a frame rate based on the timestamps of the original files.

1. Select a folder of images in the Library view.
2. Select **Export...** from the File menu.
3. Choose a name for the movie file.
4. Select **QuickTime Movie** from the **Format:** drop-down menu and click on **Options...**

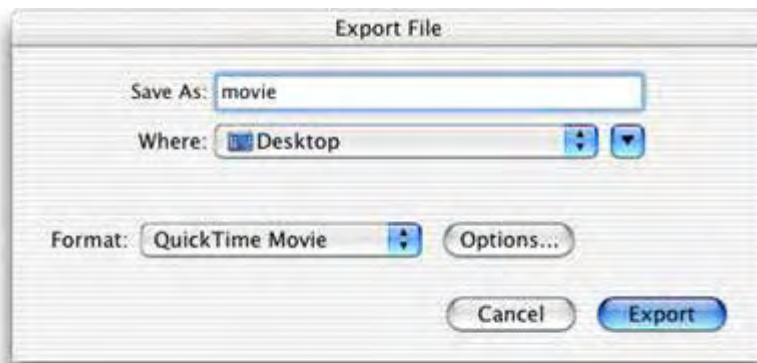

5. Select the Compression codec that should be used. The **Compressor** type and the bias towards a **Smaller File** or **Better Quality Image** will affect the size and quality of the file created. This is a subjective decision, however, we suggest that Apple Animation or the Sorenson compression may provide a good balance between quality and file size.

Exporting Items (File menu)

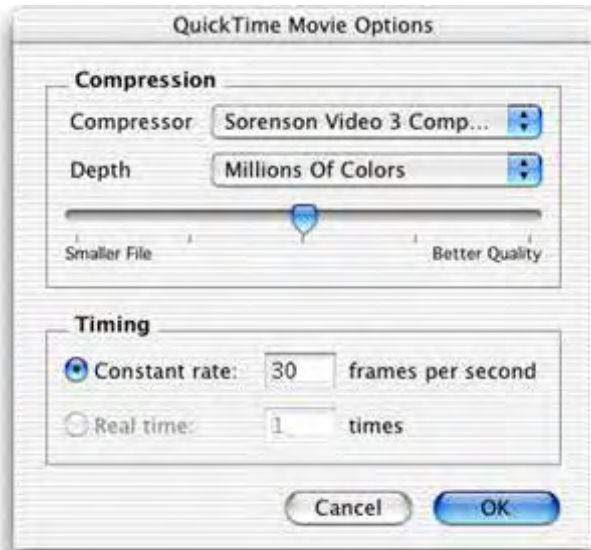

6. Select the timing required for the finished movie and click **OK**.

Export View as QuickTime or AVI Movie (Not available in Volocity LE)

When working with an image sequence which contains two or more timepoints and viewing the Image View, it is possible to make a simple QuickTime or AVI (Windows only) movie from that view.

Note: If each timepoint contains more than one plane in z, use the Extended Focus view.

1. Configure the view, as required with scale bars, selections, and so on.
2. Select **Export** from the File menu, change the file name, if required, and select a folder for the exported movie. Select **View as QuickTime movie**.

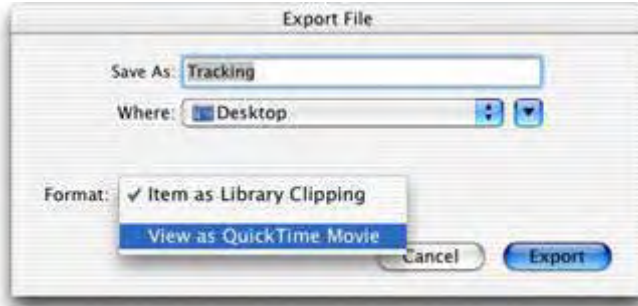

The QuickTime Movie format provides additional export options. Click on **Options...** and select the compression codec and quality, and the timing required for the finished movie, then click **OK**.

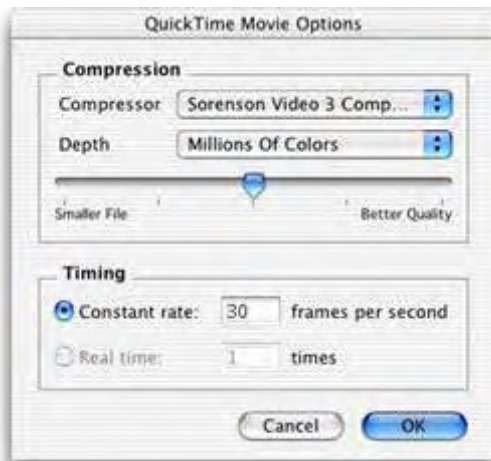

3. Click **Export**. The movie will be made by stepping through each of the timepoints.

Volocity Acquisition Installation and Reference

Overview

Volocity Acquisition is designed specifically for high performance acquisition of time-resolved, multi-channel 3D sequences. It supports a range of hardware suitable for 3D imaging, including wide field microscopes, scientific grade digital cameras, fast focus drives and wavelength changers.

It is very important to install and configure acquisition devices correctly before you start capturing images. This chapter describes how to:

- n Install and configure devices
- n Use device controls
- n Calibrate objective lenses
- n Measure device latencies
- n Configure the Light Path Manager
- n Use the Video Preview window
- n Carry out fast restoration
- n Set up and use the PerkinElmer Ultra *VIEW*[®]
- n Set up and use the OptiGrid[®]
- n Set up and use a motorized XY stage for multi-point acquisition.
- n Perform FRAP and FRAP related experiments with the FRAP plug-in
- n Perform Ratiometric experiments with the Ratio plug-in

Please refer to “Volocity Acquisition Worked Examples” on page 173 for comprehensive instructions on carrying out single-point and multi-point acquisition and information about setting up specific acquisition protocols.

Installing and Configuring Devices

1. Install your camera driver and camera (and frame grabber card, if applicable) according to the manufacturer's instructions.
2. Connect any further hardware (such as microscope, Piezo focus drive, OptiGrid®, etc.) to your computer via the appropriate port. Serial devices can be connected directly to serial ports (COM ports) on your computer, if you have them, or via a USB serial adaptor.
Note: After installing a USB serial adaptor or a major upgrade to the operating system, make sure the drivers for the adaptor are installed before connecting the serial devices.
3. Ensure that all your hardware is switched on.

Setting Preferences

1. Start the application and select **Preferences...** from the Edit menu (Windows) or the Volocity menu (Mac OS).
2. If you have connected serial devices to your computer, you must configure the serial ports. Click on the **Serial Ports** icon in the left-hand panel. If you have no serial devices connected, go to step 4.
3. For each serial port identified on the system select the appropriate type of device that is connected. For ports to which nothing is connected select "None".

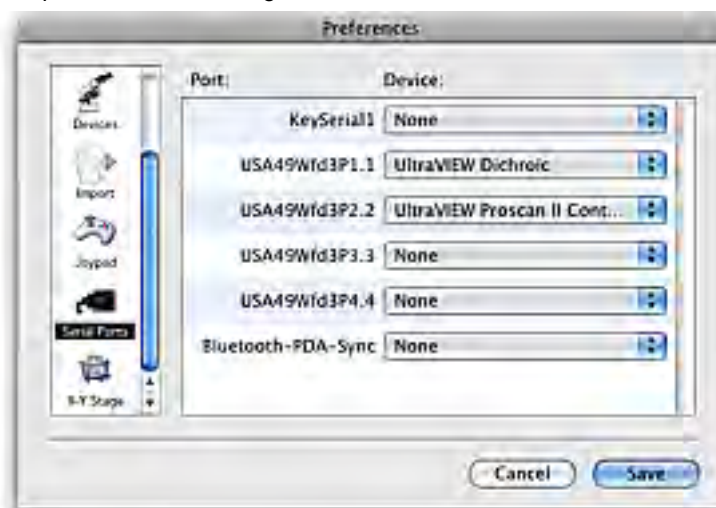

- Click on the **Devices** icon in the left-hand panel.

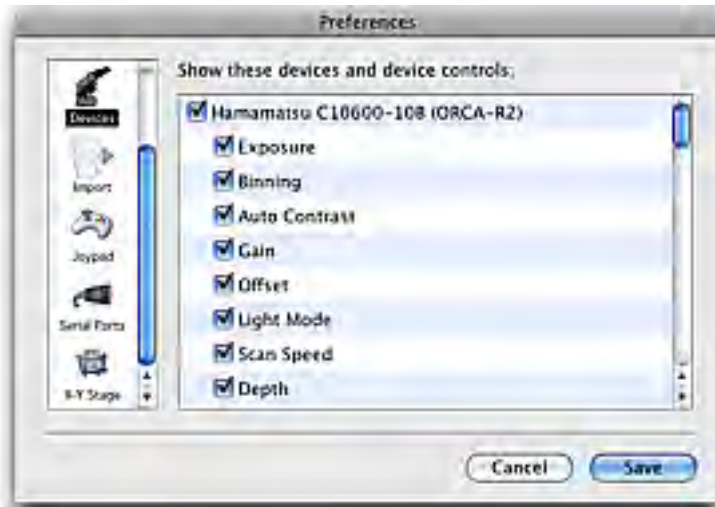

- A list of devices that have been correctly connected to your computer will appear in the right hand panel. Each device has a subset of device controls that are listed beneath the device.
To appear in the list:
 - n Cameras and USB devices must be correctly connected to your computer and switched on before starting Volocity.
 - n Serial devices must be correctly connected to your computer, switched on, and the appropriate serial port must be selected in the Preferences (see step 3).
- Carefully review all of the devices listed in the preferences; make sure that you scroll to the bottom of the list so that no devices are overlooked. If a device has an **Options...** button, you must click on the button to review the settings in the device's setup dialog. If necessary, you should edit the device's setup dialog. Failure to review and edit the dialog may result in difficulty using hardware. This may be due to incorrect labeling of devices, or because Volocity has not been given the information it requires to move the hardware accurately. See "Reviewing and Editing Setup Dialogs" below for some examples.

Setting Preferences

7. Select **Video Preview** from the Library View or **Show Video Preview** from the Window menu. The devices and device controls that were selected in the Preferences are displayed on the right-hand side of the Video Preview window.

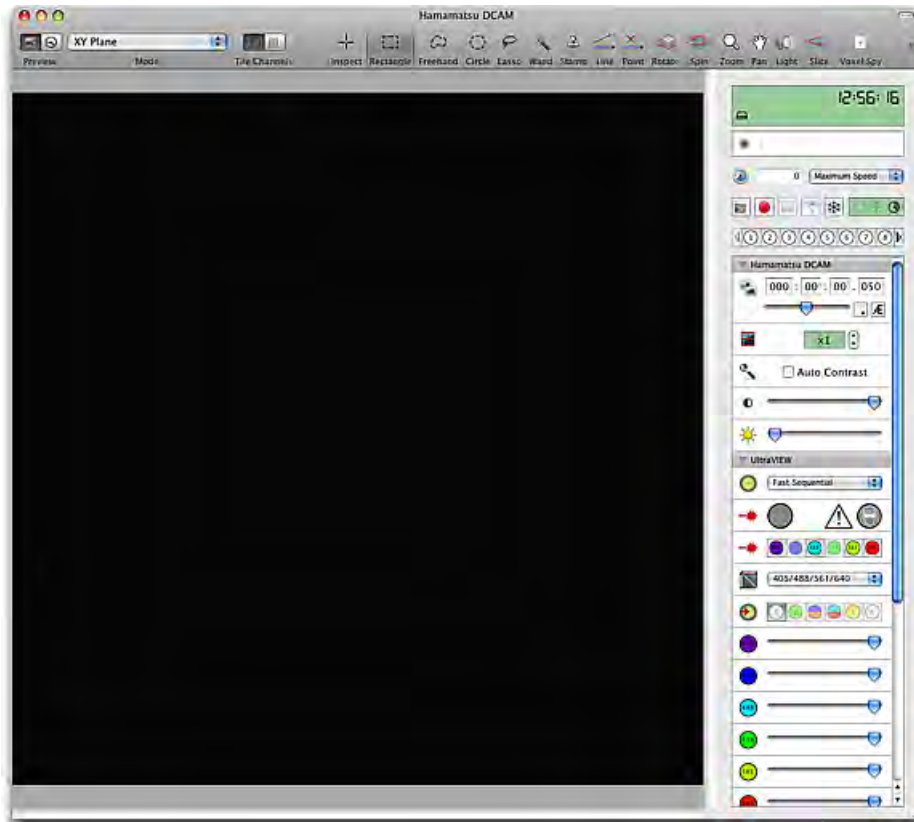

Devices are grouped according to the hardware that they refer to. Turn up or down lists of devices by clicking on the arrow next to the hardware name.

New groups of devices will appear containing the controls most used and the controls relevant to the current light path.

Reviewing and Editing Setup Dialogs

Some devices may require only a single value to be entered into a text field. Some motorized stages, for example, will require that you enter the correct step size for the stage.



Other devices may require more information to complete the Setup dialog, which should be completed in steps. For example, when completing the dialog for a filter wheel or fluo turret:

1. Select the filter type for each filter position from the drop-down menus.

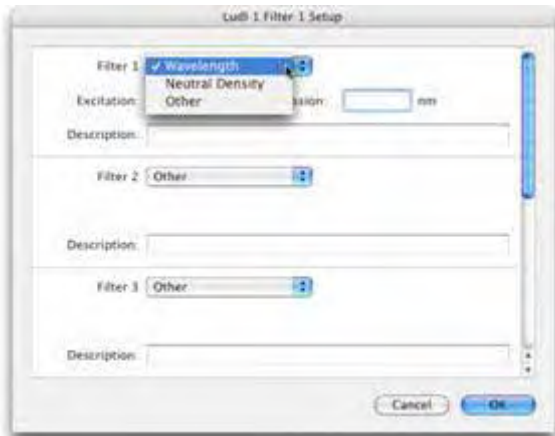

2. Enter details of the filters in the text fields.

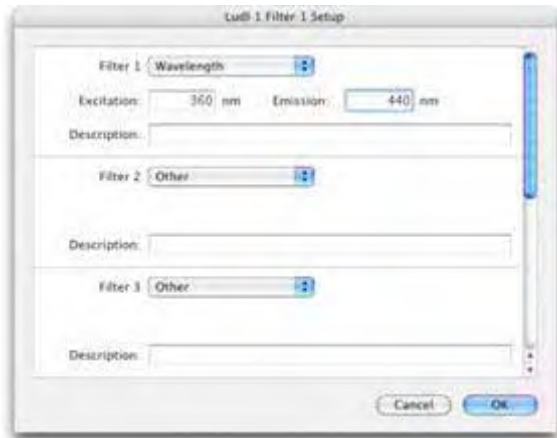

3. Name the filter in the description field.

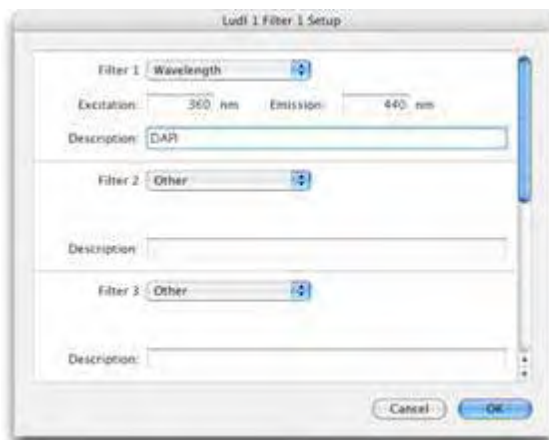

Provided that you carefully review and edit each of your device's setup dialogs, each of your devices can be used easily and accurately with Volocity. Remember to select appropriate options from drop-down menus and to carefully enter accurate information into text fields.

Device Controls

Using Device Controls

Each device that you control with Volocity will have one or more controls with which you can interact. Volocity is compatible with several classes of devices from a number of manufacturers, so the

number and types of control present for each of your devices will vary. The list of controls below is general, different controls may be present on your system.

Controls are shown in groups according to the device they belong to.

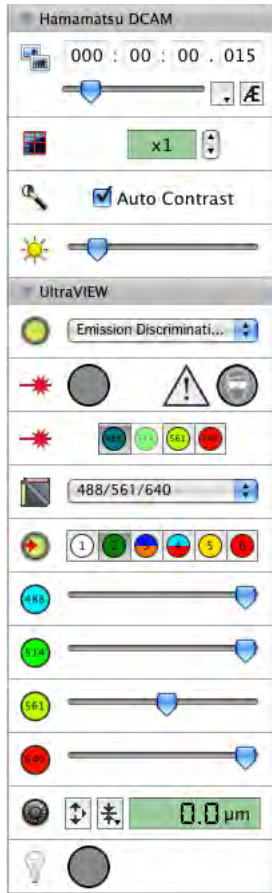

To determine to which device a control belongs, move the cursor over the icon to the left of the control. The device name will be displayed in the tooltip.



Groups of controls may be minimised to the device name by clicking on the turn down arrow.



Click on the arrow again to show the controls.

Most Used Controls

Once the system is in regular use a group of devices labeled **Most Used** may appear.



This group will contain a maximum of 5 of the controls for any device most frequently used by the current user. To appear in the list a control is adjusted in the Video Controls more than 50 times by a user. Changes to device settings made by selecting light paths or in the course of an acquisition protocol are not counted towards the usage of a control.

The **Most Used** group will only update when the screen is refreshed. Controls in this group are ordered according to number of uses. The maximum number of controls that may exist in this group is five and therefore the group may change as control usage change.

Many devices can be controlled from elsewhere, such as the microscope stand or the control box. In most cases, if you change the state or position of a device from elsewhere, the change will be displayed on the device's control in Volocity.

Double clicking a control's icon is a shortcut to the control's setup dialog.

Button Arrays



Each button in an array represents a different position for the device, for example different filter positions in a filter wheel. The button representing the current position of the device is shaded. Hold the cursor over a button to display a tooltip with a description of its position. Click on the button to move the device to that position. Filter wheels, fluo turrets, objective nosepieces and the light path manager are controlled by button arrays.

Checkboxes

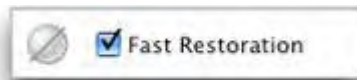

Checkboxes allow you to control devices that only have two states, on and off. When checkboxes are selected the device is on, when deselected the device is off. Auto Contrast and Fast Restoration are examples of devices controlled with checkboxes.

Digital Displays

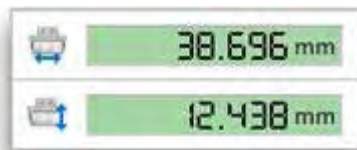

Digital displays show the current value of a device as a number, usually representing the device's current position.

Exposure Controls

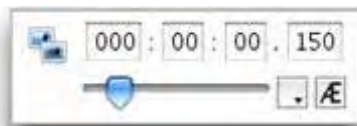

The exposure control determines the length of time over which your camera will acquire an image. The hours, minutes, seconds and milliseconds components of the time are separated for clarity. To

adjust the time click in one of the number fields and edit the number; you must click in another field or press the Return key for your change to take effect. You can also drag the exposure slider to make quick changes, the exposure time will automatically update. Use the drop-down menu to change the range.

If you click the Auto exposure button, **AE**, exposure time will be automatically set.

Focus Controls



Focus controls display the current position of focus drives as a numeric value. If the hardware has focus controls outside the software you will see changes in the hardware reflected in this display.

Top and bottom positions in the focus control are essential to the acquisition of 3D stacks. Setting top and bottom positions specifies the location and thickness of any stack acquired when the same focus drive is selected in the **Channels/Z** tab of the Acquisition Setup dialog. The thickness of this stack is shown by the range field on the focus drive slider.

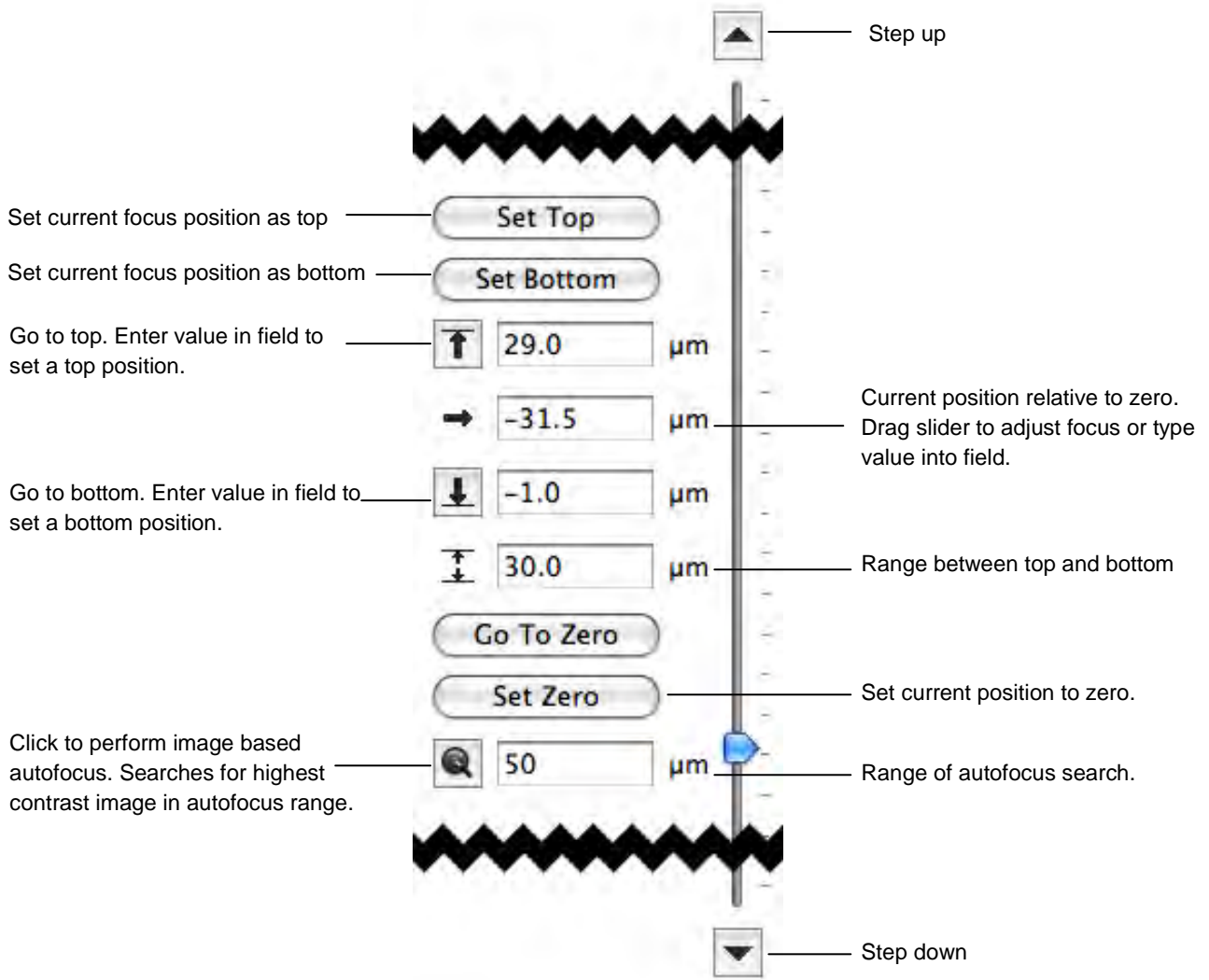

Grid Controls



There are three grid controls. From left to right:

- n **Grid Off:** Switches the grid off. There is a stationary grid pattern on the Video Preview and from the ocular lenses of the microscope.
- n **Grid Confocal:** Activates the grid. There is a confocal image on the Video Preview and a moving grid pattern from the ocular lenses of the microscope.
- n **Grid Wide Field:** Activates the grid. There is a wide field image (without grid lines) on the Video Preview and a moving grid pattern from the ocular lenses of the microscope.

Numeric Spin Controls



Numeric spin controls allow you to quickly increment or decrement the current value of the control by clicking on the arrows next to the number display. Camera binning is an example of a device controlled with a numeric spin control.

Drop-down Menus



Drop-down menus allow you to select from a number of options for a device. Click on the drop-down menu to see all of the options, and select the option you require. Camera depth and grid quality are examples of devices controlled with drop-down menus.

Shutters

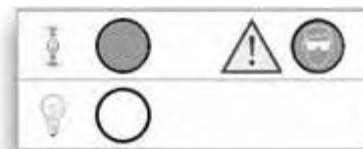

Click directly on the shutter icon to change its state. Solid indicates shutter closed. White indicates shutter open.

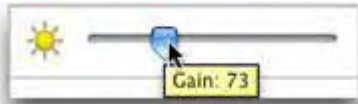
Sliders

Sliders allow you to quickly set a device control anywhere between its maximum and minimum values. Hold the cursor directly over the slider to display a tooltip showing the current value of the control. Camera gain and offset are examples of devices controlled by sliders.

TTL Controls

Set TTL outputs high by clicking on the button(s) corresponding to the desired line(s).



TTL input status is reflected by a bank of 'lights' one for each line. Brighter light indicates that the line is high.

Calibrating Objective Lenses

In order to ensure that the data acquired with your Acquisition system is correctly calibrated in X and Y, each objective lens on the microscope should be calibrated for any camera on the system using lens a stage graticule.

1. Place the graticule slide on the stage and focus on the scale divisions.
2. Select the Calibration tool from the toolbar.



3. Draw a line of known length on your Video Preview. Click and hold your mouse to start the line, drag the mouse to the endpoint of your line and release the mouse button.

Calibrating Objective Lenses

- Remember to draw from the left of your start division to the left of your end division, and make the line as long as possible to minimize the effect of drawing errors.

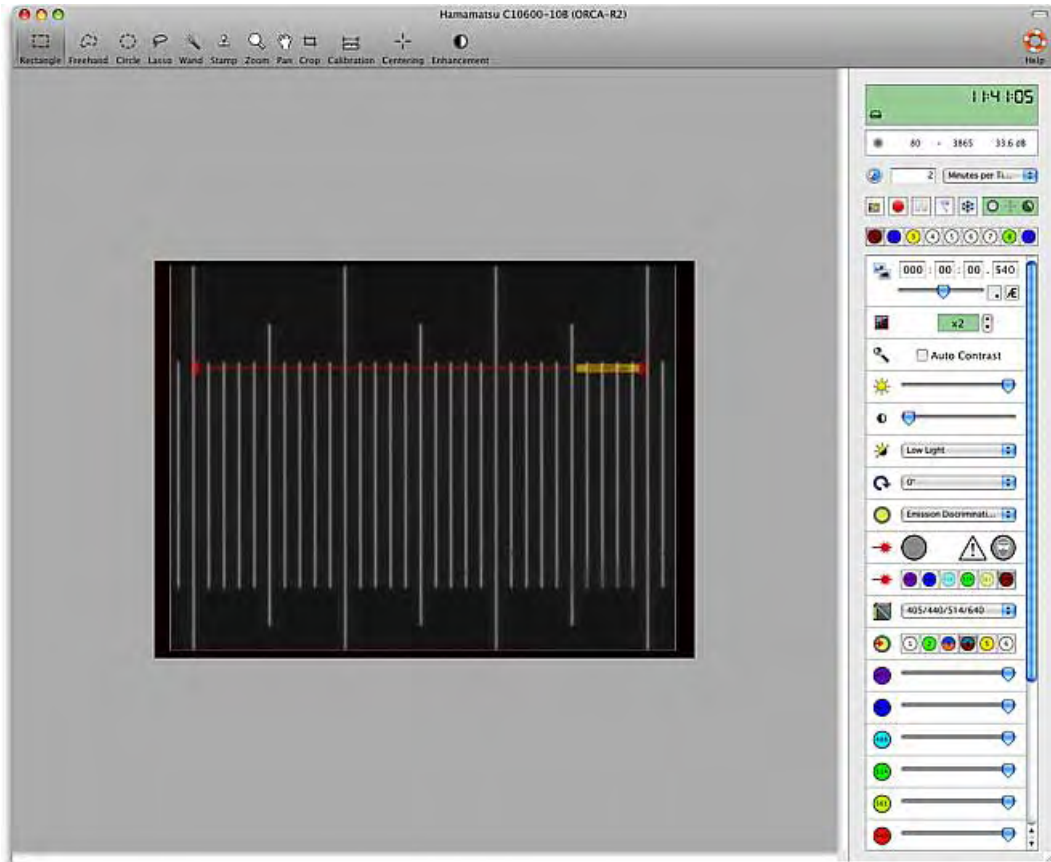

- Select **Calibrate...** from the **Video** menu or double click on the Calibration tool to open the calibrate window.



6. Enter line length in μm and click **Calibrate.**

To confirm that your objective lens has been correctly calibrated, select **Show Scale** from the Video menu. You can then compare your scale bar to the calibration divisions.

Repeat this process for every objective lens on your microscope. The calibration is stored with the objective position and will be recalled when a lens is selected.

7. Repeat this process for any additional camera on your system. The correct set of calibrations for the objective lenses will be restored when the camera is selected.

If you already know how many $\mu\text{m}/\text{pixel}$ your camera has for your current objective lens, double click on the calibrate tool without first drawing a calibration line on the video preview. You will be able to enter the $\mu\text{m}/\text{pixel}$ value directly into the Calibrate window. You should repeat this for each lens.

Measuring Device Latencies

You should use this option when you first install and configure Volocity and also whenever you attach new equipment or use different equipment. Volocity will measure the latencies of all computer-controlled hardware on your system, which will allow Volocity to make intelligent decisions about closing shutters during acquisition.

1. Select **Measure Device Latencies from the Video menu to display the following prompt.**



2. Check that there are no samples and that your microscope is in a safe position (for example, check that your objectives will not collide with your stage if your objective turret is moved). Click **Continue.**

When you have completed these steps your Acquisition system will be correctly configured and ready to use.

Note: The latency measurements are noted in the Session Log. If you wish to know them, view the Session Log at the time of measurement. See page 35.

Light Paths

Configuring the Light Path Manager

The Light Path Manager is above the device controls in the Video Preview window and allows you to configure up to thirty two different light paths and store them for future use.



The Light Path Manager allows you to record the positions of all your automated hardware in the combinations necessary to image each fluorochrome, or channel, as well as transmitted light paths. This greatly simplifies the use of your system and allows you to easily restore the correct light path manually (using the Video Preview window) or during acquisition. You can record the positions or settings of as many or as few devices as you require. For example, you may keep your light path simple and include the positions of only wavelength changing devices and shutters. Under some circumstances you may add other settings to the light path, such as your camera exposure or gain.

Light path settings are stored per video source and per user account.

1. To create a light path double click on an unused light path manager button. The Light Path Properties dialog opens. From the Devices list select those devices that you wish to include in the light path. Select the appropriate shutter positions for your light path from the drop down menus in the Shutters list. As each device is added the current value of the device is stored in the light path.

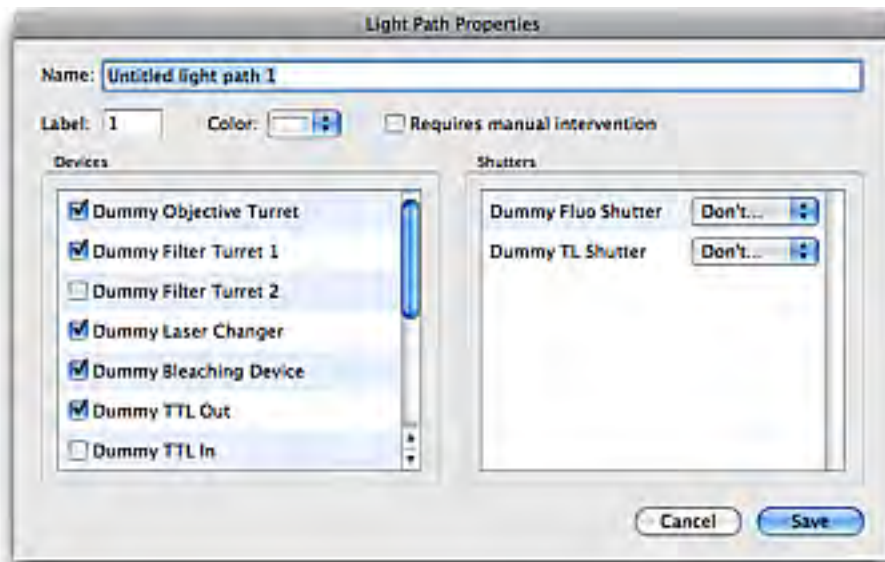

2. Provide a **Name** for the light path and select a **Color**. The color will be used for the light path button, and to color channels acquired using the light path. If you are setting a transmitted light path the

color should be white. The Summary box provides a useful text description of the settings that you have included in the light path.

3. If the light path requires changes in the microscope setup that are not controlled by Volocity, for example moving a manual filter changer, check the box for **Requires manual intervention**. A message will be shown each time the light path is called prompting you to make the manual change.

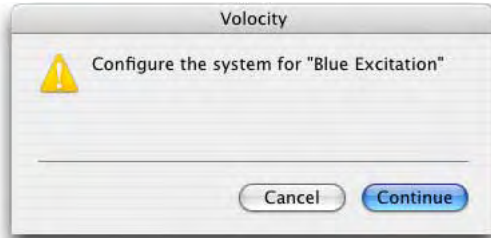

In the following example we have set up the light path for a DAPI channel. We have saved the current positions of the Fluo Turret and Sutter DG4 Filter Changer in the light path. The Fluo Shutter and Sutter DG4 Shutter will be opened whenever the light path is restored.

4. Click **Save**.
5. The newly created light path will now be selected and its stored settings applied. The controls stored by this light path will be reflected in the first group of device controls in the Video controls panel.



If necessary these controls can be adjusted and the changes saved to the light path by clicking on the save button.

6. Set up a separate light path for each fluorochrome and transmitted light path that you will use on your system.

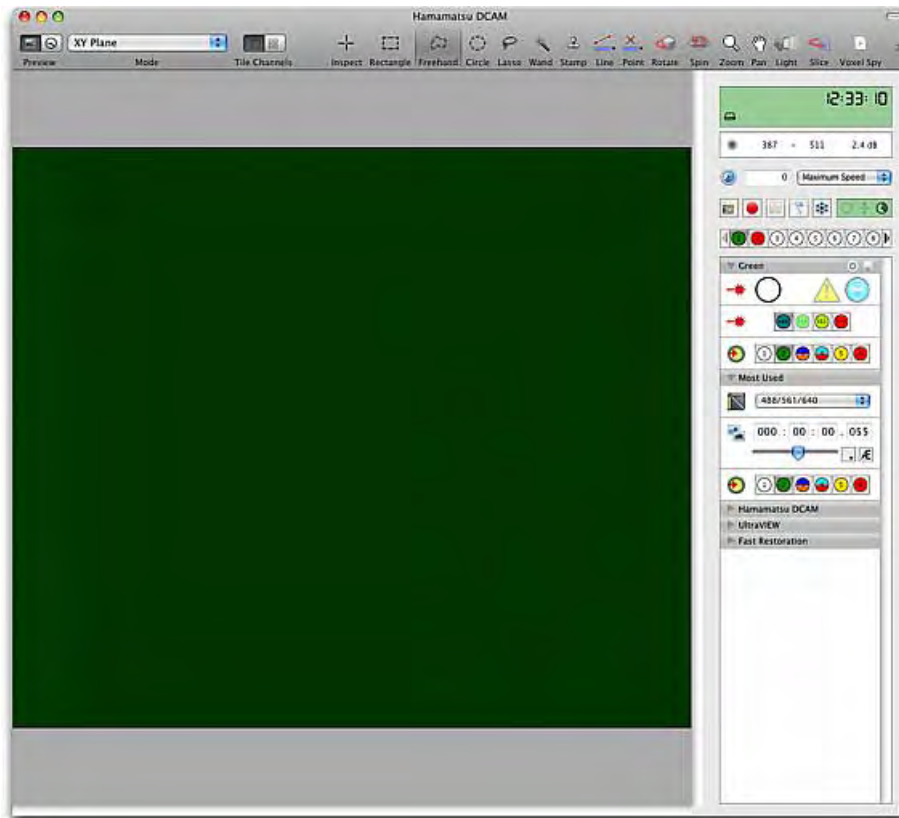

Editing Light Path Settings

You can easily edit a light path, to store a different value for a device using the device controls group for that light path.

1. Select the light path in the panel so that it is current and the device controls group are for that light path.

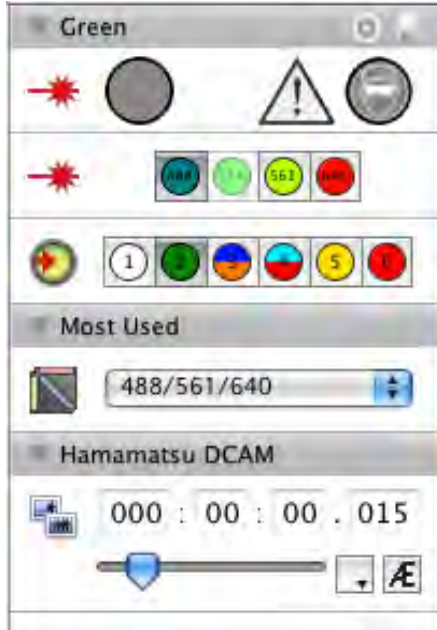

2. Change the control(s) as required and click on the save icon to store the new settings for that light path. Although the current state of a shutter can be changed using the control in a light path group this change will not be stored, shutter management is critical to the success of experiments.

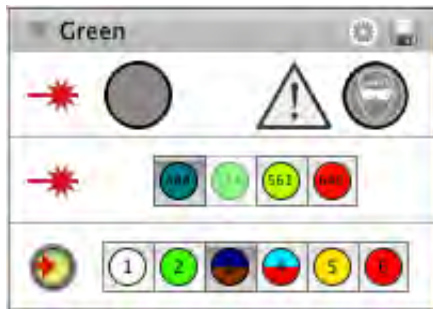

To change the shutter management for a light path, add or remove devices from the light path, make the changes in the Light Path Properties dialog. Click on the cog icon in the title bar of the light path device controls. Check a control name to add its state to the light path. Uncheck a control name to remove it. Change shutter management with the options on the right.

The Video Preview Window

Open an existing library or create a new library and select Video Preview or select Show Video Preview from the Window menu.

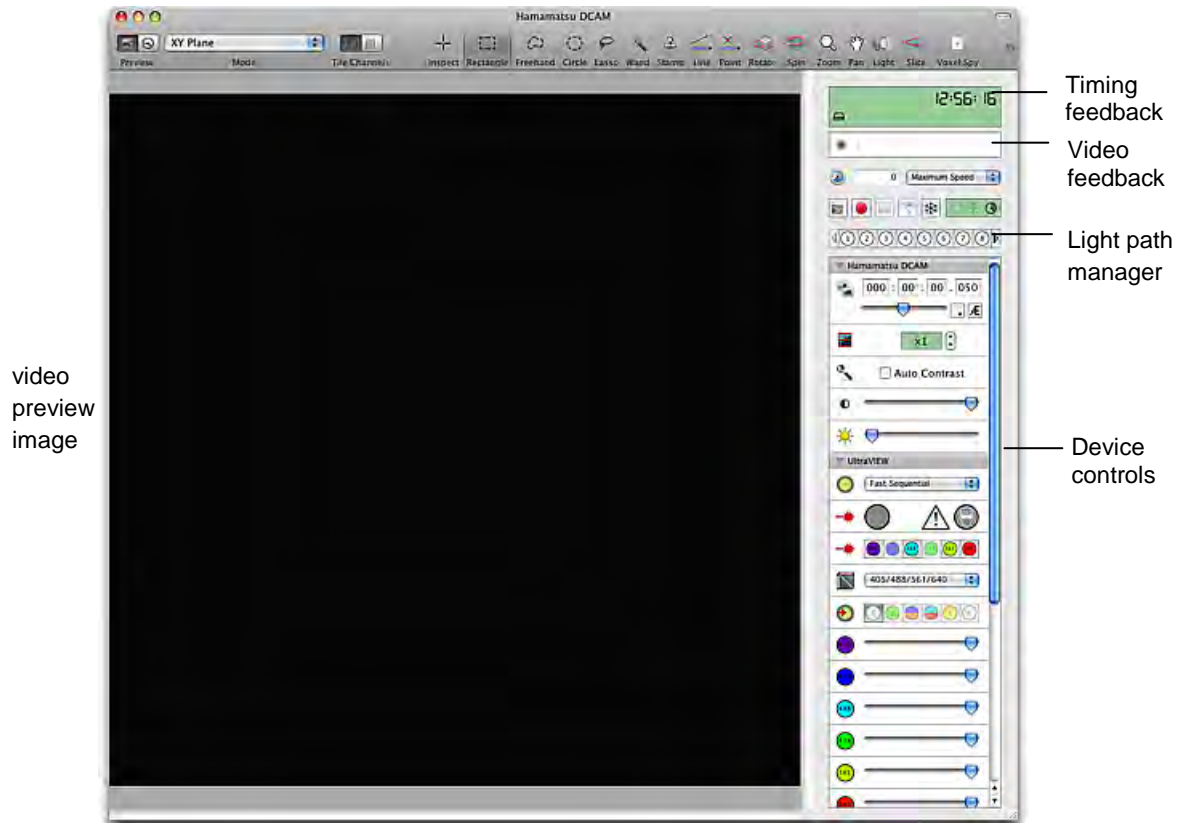

Video Source

In the Video menu a **Source** option allows selection of a camera on the system. Cameras must be correctly installed and powered to appear in this list. Use the **Source** option to switch between cameras. Where applicable the option **Multi Camera** will allow two cameras to be used simultaneously for imaging. The Multi Camera must be configured in the Device Preferences and alignment between the two cameras calibrated.

Preview

Preview frames. Frames are displayed individually each frame replaces the previous frame.



Preview timepoints. Video Preview is updated as each timepoint is acquired. Available for live preview as well as during experiment acquisition. The current acquisition protocol will run to generate the preview. No images will be acquired. Previewing timepoints may not be suitable for photo-sensitive samples or samples which suffer rapid photobleaching. Since the acquisition protocol is running it is necessary to switch to preview frames to regain control over shutters. Additional modes of display and tiled channels are available when previewing timepoints.

Mode

Change the mode of display for the Video Preview. Modes available will depend on Volocity products licensed for the system. When previewing frames only XY plane mode is available.

Channel Display

Choice over channel display is only available when previewing timepoints.



Overlay channels. Where two or more channels are previewed or captured they will be shown overlaid.



Tile channels. Where two or more channels are previewed or captured show each channel as a separate tile in the view plus an overlay of all channels.

Video Preview Toolbar

All selection tools are supported in the Video Preview. To draw a region of interest on the Video Preview, select the ROI tool, click and drag your region of interest. With an ROI on the preview, only the area within the ROI will be used for the video feedback panel.



The Video Preview shows zoom to fit behaviour. If the window is made larger or smaller the image is resized accordingly. Use the zoom tool to magnify the image by multiples of its original size. Click and hold the Ctrl key (Windows) or the Alt key (Macintosh) to zoom out. When the zoom tool is in use an overlay on the image shows the percentage zoom. Double click on the zoom tool in the toolbar to restore zoom to fit behaviour. A zoomed window can be scrolled from left to right or up and down using either the scroll bars or the window panning tool.



Spot Tool. Define spot bleaching for devices which support spot bleaching.



Use the Voxel Spy tool to determine intensity values for individual voxel in the preview.



The Video Preview can be cropped, so that smaller images will be acquired by Volocity. With some cameras cropping will provide a speed advantage. To crop the preview select the Crop tool, click and drag a crop boundary on the Video Preview. Everything that you include within your crop boundary will continue to be updated on the Video Preview, everything outside the boundary is not updated. You can also crop the Video Preview to preset sizes by selecting Crop Video from the Video menu and selecting one of the options. To restore the full resolution Video Preview, select the crop tool and click anywhere outside the crop boundary.



Use the calibration tool to set up spatial calibration for each objective lens on the system.



On a system which includes a motorized XY stage the centering tool will move the XY stage so that the point in the video preview clicked on with the tool is centered in the field of view. The stage and the objective must be calibrated for this tool to work correctly. For more information on use of a motorized stage see page 206.

Contrast Enhancement

Contrast enhance the live video to reveal detail captured by the camera but not shown by the default display contrast. Check Auto Contrast on the video controls to apply an automatic contrast setting which will adjust the black and white level of the display to the darkest and brightest captured intensity respectively.

Alternatively manually set black and white levels of the video preview using the live enhancement tool.



Select the live enhancement tool from the toolbar. A small histogram of the grey levels in the preview is displayed. To adjust the white level click and drag the cursor anywhere in the preview pane moving to the left (to decrease) or to the right (to increase). To adjust the black level, hold down Ctrl and click and drag the cursor anywhere in the preview pane down (to decrease) or up (to increase). Move the cursor slowly for finer control over settings. Double click the icon in the tool bar to reset the contrast enhancement. Select another tool to remove the histogram overlay from the screen.

When contrast enhancement is being applied an indication will be shown in the top left of the video preview image.

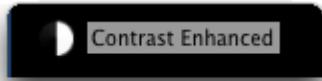

Setting CCD Active Area

Some combinations of optical components do not generate an image to fill the full CCD of the camera leaving margins around the images. To avoid storing these set the CCD active area to exclude them.

Select **CCD Active Area...** from the Video menu.



Set margins to exclude or set the active area to the dimensions and position of an ROI which can be drawn on the video preview before selecting this dialog.

Video Feedback Panel

Information on the gray levels in your Video Preview can be found in the Video Feedback panel, in the top right of the Video Preview window. The information can be displayed in four different modes, **numbers**, **histogram**, **bar** and **Max Intensity graph mode**.

To toggle between the four modes, click on the Video Feedback panel.

Numbers mode



The Video Feedback panel displays the minimum and maximum gray level in the Video Preview, and the signal to noise ratio.

Histogram mode



The Video Feedback panel displays the distribution of gray levels in the Video Preview. The minimum gray level is displayed on the left of the histogram, the maximum gray level (which depends upon the bit depth of your camera) is displayed to the right of the histogram.

Bar mode



The Video Feedback panel shows the range of gray levels in the Video Preview. The length of the bar indicates how much of your camera's dynamic range you are currently using. The longer the bar, the better your signal to noise ratio.

Max Intensity graph mode



The Video Feedback panel shows the maximum intensity of gray levels in the Video Preview or ROI over time. An update is made for each frame.

If you have a color camera, you will see feedback for each of the three channels of your camera in addition to a luminance channel.

Acquisition Setup Dialog

The Acquisition Setup dialog is the location for configuring an experiment. You only need to set up those steps that are appropriate for your acquisition protocol.

There may be some preparation in the Video Preview necessary before an experiment will run as required.

- n If you wish to capture multiple channels you will need to configure light paths, one for each fluorochrome or colour in the sample. See Configuring the Light Path Manager on page 164.
- n If you wish to capture a single plane only, ignore the focus drive options and go to step 3.
- n If you wish to capture a number of Z sections within your specimen, you will need to set the range through which the focus drive will move in the focus interface in the Video Preview.

First, move to the midpoint of your specimen using the focus control of your microscope.

Select **Set Zero** from the focus drive slider by clicking on the focus control to show the focus slider.

Move to the lower limit of your specimen and click **Set Bottom** from the focus drive control.

Move to the upper limit of your specimen and click **Set Top** from the focus drive control.

1. Select **Acquisition Setup...** from the Video menu.

Or double-click on the acquisition protocol feedback display on the Video Preview window.

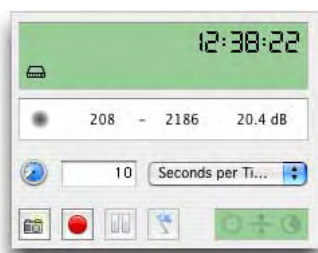

— acquisition protocol feedback display

Acquisition Setup: Channels/Z

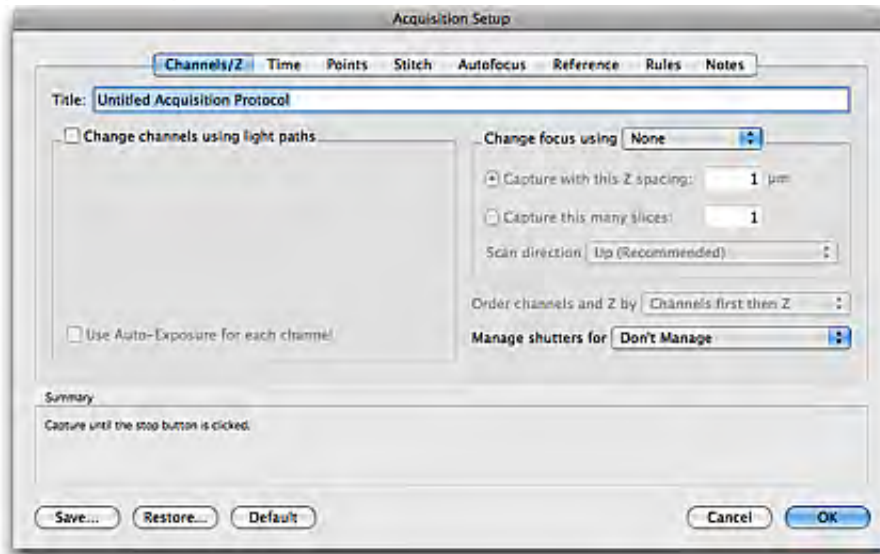

The dialog is divided into tabs according to the type of experiment being performed. Configure only the tabs needed and you may ignore the rest. Check the summary to make sure a previous user has not configured a step you do not want. To reset all tabs to the settings for a single channel timelapse click the **Default** button.

2. Change channels using light paths

If you wish to acquire a multi-channel sequence check the **Change channels using light paths** box.

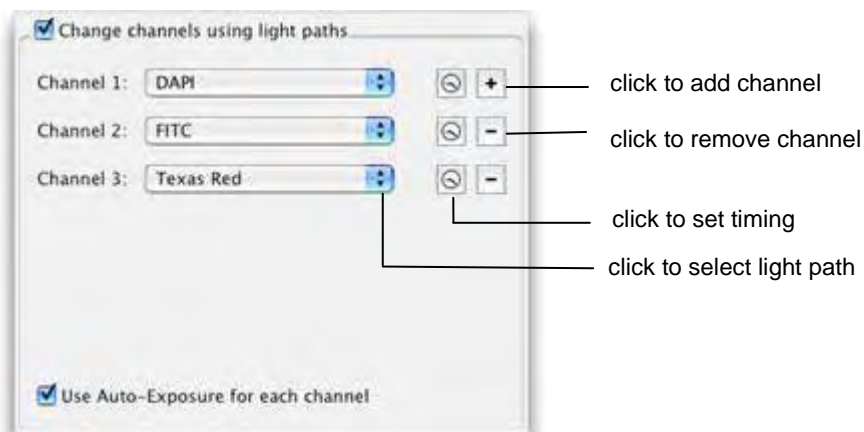

Add or remove channels using the “+” and “-” buttons and select the correct light path for each channel by clicking on the drop-down menus.

If you wish to acquire a channel at a rate different to other channels (for example, you may wish to acquire a fluorescence or brightfield reference image periodically), click on the timing icon. The **Channel Timing** dialog opens. Select the **Acquire a new frame for this channel every:** option, and enter the new frame rate.



A warning symbol is displayed on the Acquisition Setup dialog next to the channels that will not be captured at the normal rate.

During timepoints in which a channel is not acquired the last timepoint that was acquired will be duplicated.

If you wish to acquire a channel with only one z plane, to act as a reference channel in the final dataset select the light path for that channel here and use the Reference tab to select which plane to acquire.

Auto-Exposure

If you wish Volocity to perform an Auto-Exposure for each channel, check the **Use Auto-Exposure for each channel** box. With this option selected, Volocity will perform an Auto-Exposure at the midpoint of your specimen for each of your channels before starting the acquisition.

Changing the exposure between channels reduces the speed of the acquisition protocol and should be avoided for speed-critical acquisition. Often a compromise exposure that is adequate for all channels can be found.

3. Change focus using

If you are acquiring multiple Z sections, select the appropriate device from the **Change focus using** drop-down menu and enter either the **Z spacing** that you require or the number of **slices** that you require.

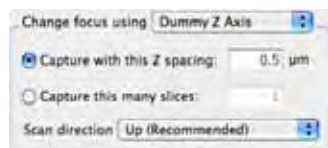

Using the Z spacing option Volocity will calculate the number of slices required to move through the range between the top and bottom positions as configured in the focus control. If the Z spacing is not a factor of the range, an additional slice will be captured.

Using the number of slices option Volocity will calculate the spacing between slices required to capture that number of slices within the range between top and bottom.

The scan direction option allows you to select between:

- n **Up:** This is the recommended option; it moves the focus device against gravity for the most accurate positioning.
- n **Down:** This option moves the focus device with gravity.
- n **Bi-Directional:** This option alternates the up and down direction of focus movement. This may minimize disturbance of the system by avoiding the relatively large movement otherwise required to return the focus to its starting position.

To use autofocus, for 2D or 3D acquisition and either in software by finding the highest contrast or by using a microscope focus holding device use the **Autofocus** tab. See page 182.

Order channels and Z sections by

If you are acquiring both multiple channels and multiple Z sections you must decide in which order Volocity will acquire your images.

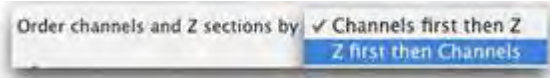

There are two options in the **Order channels and Z sections by** drop-down menu.

The **Channels first then Z** option acquires all channels at each Z section before the Z section is changed. This option has the advantage of acquiring all channels at precisely the same Z section, but may be slow with a slow wavelength changing device.

The **Z first then Channels** option acquires all Z sections for each channel before the channel is changed. This option has the disadvantage of introducing potential inaccuracies in Z positions (depending upon the reproducibility of your focus drive), but it does allow acquisition protocols to be conducted at high speed, even with relatively slow wavelength changing devices.

10. Manage shutters for

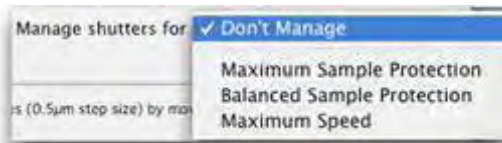

These options determine how Volocity will manage the shutters between channels and timepoints. Volocity uses the latency threshold measurements for each device in the light path to determine how it will control the shutter. You must have measured your device latencies for this option to work effectively, see page 163.

Acquisition Setup: Time



Timelapse

Set the frequency between timepoints by configuring timelapse settings.

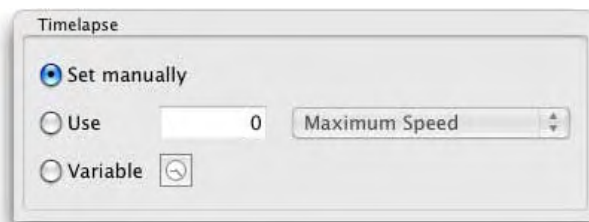

- n **Set manually** Use the setting on the Video Preview (see below)
- n **Use** Set the interval between timepoints.
- n **Variable** Click on the clock icon and add different phases using the “+” button. Define the length of each phase and the timelapse interval to use during that phase. To pause acquisition select 0 timepoints per second for the required time.

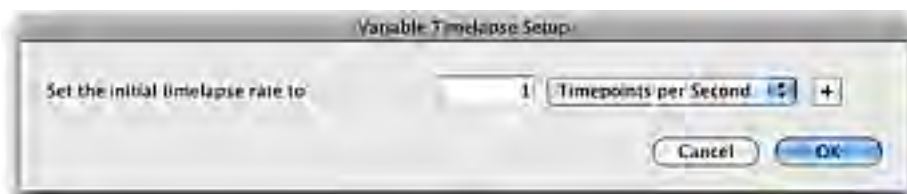

You can change the timelapse option at any time during an acquisition. If you wish to acquire only a single timepoint, you can ignore the timelapse options.

For example, to acquire one timepoint every 10 seconds, select **Seconds per Timepoint** from the drop-down menu, and enter **10** into the text field.

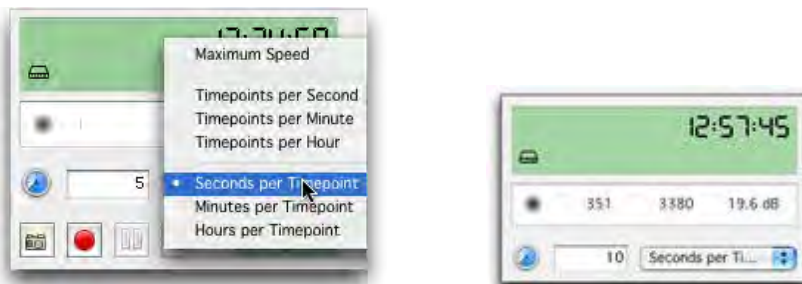

If you wish to acquire images at the fastest possible rate, select **Maximum Speed**, Volocity will then acquire the images at the fastest rate supported by your hardware.

Duration

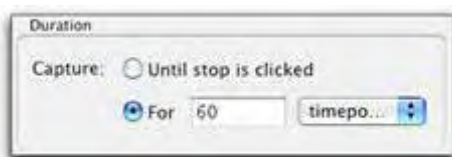

If you wish to acquire multiple timepoints, select either **Until stop is clicked** (Volocity will acquire data until it is manually stopped) or select **For**, enter a number into the text field and select either “timepoints”, “ms”, “seconds”, “minutes” or “hours” from the drop-down menu.

If you wish to acquire a single timepoint, select **For**, enter “1” into the text field, and select “timepoints” from the drop-down menu.

Acquisition Setup: Points

The points tab of the acquisition protocol configures the use of a motorised XY stage to acquire at multiple sample points.

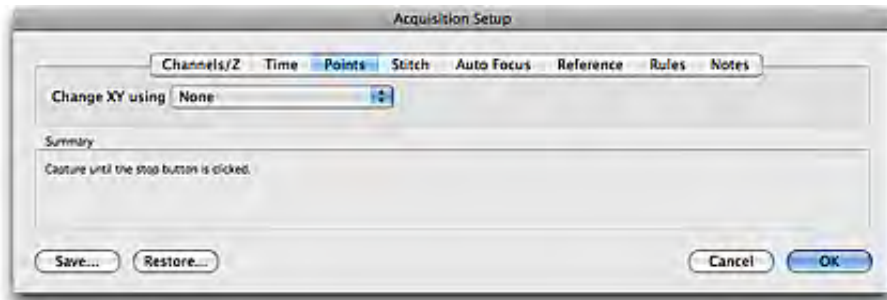

Points in the stage area must be stored before an acquisition protocol can be configured to use them. See Adding Points on page 212.

The XY stage must be configured with a focus drive for storing positions. See Set Up and Calibrate the XY Stage on page 206.

The focus drive that you select for the stage may be different to the focus drive that you select for acquiring stacks in the Channels/Z tab. This will allow you to move between acquisition points with a microscope focus drive, and to capture Z series with a piezo drive.

To use a configured stage in an acquisition protocol and perform a multipoint experiment select the Points tab and choose the stage in **Change XY using**.

To perform an experiment at only one location set the option **None**.

Other tabs are configured as required for the channels and/or stacks to be acquired at each XY location. When the experiment is run each point stored by the stage will be visited in turn and the required steps executed. This will be repeated to meet the requirements set in the Time tab.

When the acquisition is run an image sequence is created for each point. All the image sequences from a single multipoint acquisition are organized within a folder in your library.

Acquisition Setup: Stitch

Volocity may be configured to acquire multi-channel 2D, 3D and 4D images which are made up of multiple fields stitched together to create large high-resolution images.

For successful stitched imaging it is essential that the objectives and XY stage are correctly calibrated. Fields are calculated to overlap by 10% of their dimensions.

To stitch images to cover an ROI the ROI must be specified in the XY stage view.

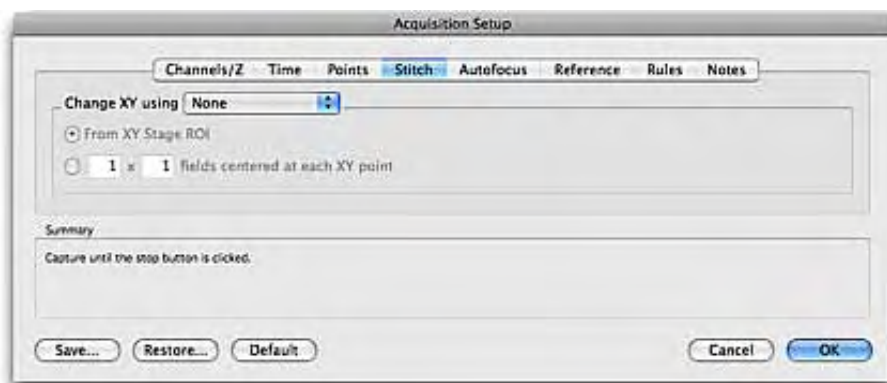

Select the XY stage to be moved to generate the stitched images.

- n From XY Stage ROI will acquire the minimum number of fields to completely cover the ROI.
- n fields centred at each XY point will acquire the specified matrix of fields. If no points are specified the current stage position is made the centre point.

For either case the channels, z-stack and other options will be repeated for each field in the stitched image.

For visualization and processing of stitched, multi-field images a 64-bit platform is recommended.

For creating an single channel, 2D overview of a stage area to assist in the placement of acquisition points use the scan function in the XY stage view see page 216.

Acquisition Setup: Autofocus

There may be two methods of autofocus available on the system:

1. Image based autofocus will search for the highest contrast image from its current position staying within the range set in the autofocus limits field on the slider for focus control in the Video Preview.

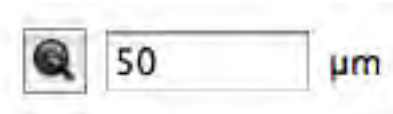

The position at which this higher contrast image is found will become the new current focus position.

2. Hardware based autofocus devices will maintain focus at the specified offset from a physical location such as the coverslip. See the Volocity Supported Hardware list for details of such devices supported by Volocity. Specific instructions for each supported device use in Volocity are also available in the technical note library at <http://www.improvision.com/support>. Refer also to documentation from the device manufacturer. Examples of such devices are the Perfect Focus System or Zero Drift.

Autofocus Tab

Using autofocus during an experiment or acquisition protocol by configuring the Autofocus tab. Select a device to autofocus with.



Image Based Autofocus

To use image based autofocus select one of the focus controllers on the system such as the microscope focus or piezo. Use the fastest focus device available on the system for best results.

Select a light path to use to create the image. This light path must be configured in the light path manager but does not need to be a light path that is used in the Channels/Z pane. Since image based autofocus works by testing images for contrast a light path which generates high contrast images quickly would be the best choice here. See page 164 for more information about creating light paths.

Hardware Autofocus

If the system includes a hardware device to maintain constant focus select the device from the pop-up. Volocity will activate the focus device to maintain the offset specified for the device each time the autofocus is used. It is usual to configure the offset to be maintained by the device when setting up the sample on the microscope.

When using one of these devices is not necessary to have the sample illuminated therefore the light path used for auto focus can be one in which shutters are closed or illumination intensity is low, this will protect the sample.

All Autofocus Routines

Using autofocus will reduce the speed of acquisition by the time taken to determine the best plane to image.

Choose the frequency to apply autofocus by configuring the timing options. Autofocus at each point and autofocus for each well apply to acquisition using a motorized XY stage. Other options apply to timing of the autofocus.

Autofocus with Z stack Acquisition

When acquiring a z stack around the position determined by the auto-focus the setting of top and bottom positions in the focus drive settings become vitally important as described below.

Each of your acquisition points will be treated as zero, regardless of its actual Z value. So the distance between zero and your top and bottom position will be the same as the distances between each of your points and their top and bottom positions (see the tables below for examples). You can quickly check what values are set for top and bottom by inspecting the focus drive tool tip.

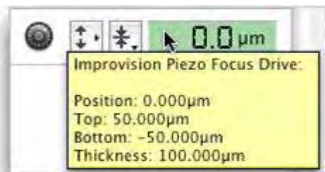

Top and Bottom marks with top set to 5 and bottom set to -5

Position (Z) of acquisition point (µm)	Bottom mark for acquisition (µm)	Top mark for acquisition (µm)
0	-5	5
10	5	15
20	15	25
30	25	35



Top and Bottom marks with top set to 10 and bottom set to -10.

Position (Z) of acquisition point (µm)	Bottom mark for acquisition (µm)	Top mark for acquisition (µm)
0	-10	10
10	0	20
20	10	30
30	20	40



If you wish to change the top and bottom positions, use the commands in the focus drive drop-down menu, as described in step 2 of this section.

Note: You should avoid re-setting the zero value of your focus drive after setting your acquisition points. If you do so, you will invalidate the Z coordinates stored with each point.

Acquisition Setup: Reference

A reference image is a single plane image within a 3D sequence. They are intended as special channels containing information that relates to but is not the same as the 3D images. Reference channels are visualised in a different way to other channels. Reference channels may not be the target for intensity based selection, measurements are not made on reference channels and reference channels may not be deconvolved.

To capture a reference channel:

- n the light paths for the experiment must already be configured in the Channels/Z tab and these light paths should include the one that will be used for the reference channel
- n the change focus using option to capture a stack must be configured in the Channels/Z tab

Select the **Reference** tab. Select the channel and the Z position.

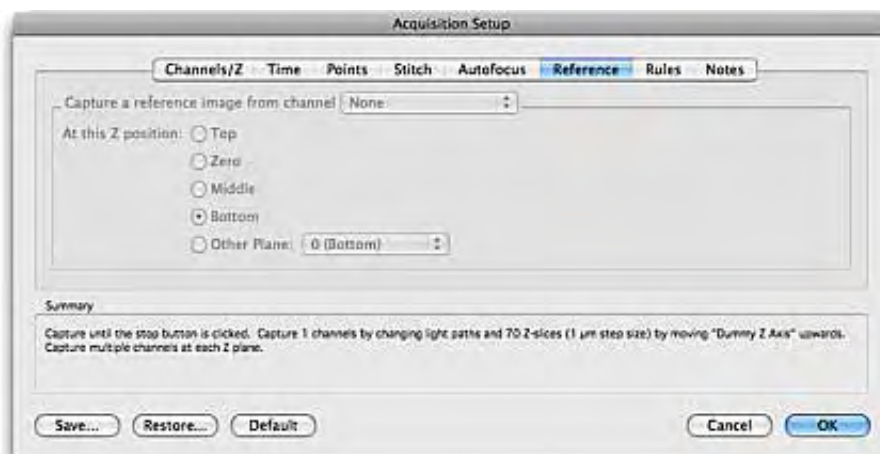

In a time resolved experiment use the timing options for each channel in the **Channels/Z** tab to capture the reference channel at a different frequency to the rest of the channels.

The order in which channels are acquired, including the reference image is dictated by the order in the Channels/Z tab.

The z position of the reference image relates to the current stack dimensions. These will depend on the top and bottom positions set in the focus control and the slice number as set in the Channels/Z tab. If stack dimensions are changed between experiments top, middle and bottom positions will always honour the current stack size. If another plane is selected and this number plane is not available in the current stack the nearest available number plane will be used.

Acquisition Setup: Rules

Acquisition protocols can be made more flexible by implementing rules. Rules allow Volocity to detect external conditions, and to respond by executing one or more actions. Volocity is able to detect time changes, device value changes, and keystrokes. Volocity is able to respond with changes to the acquisition state (pausing, resuming, and stopping the protocol), changes in device values and by logging events.

To implement acquisition rules select the Rules tab in the Acquisition Setup dialog.

Acquisition Setup Dialog



Add a rule by clicking on the Add Rule button.

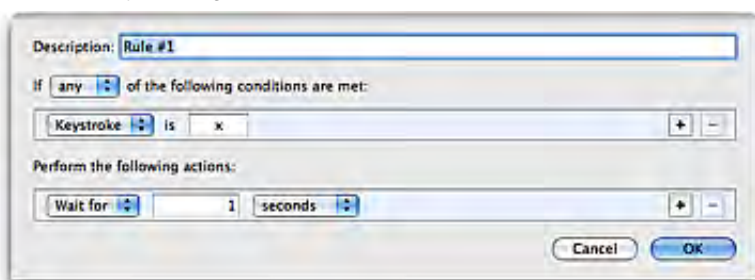

Select the condition to be met.



- n Keystroke - type any alphanumeric key.
- n Time - select before, after or every and a time in timepoints, milliseconds, seconds, minutes or hours.
- n Device - select a device name and configure the control to the state that is to be detected.

More than one condition can be included in a rule by clicking +. A rule can require any or all of the conditions to be met.



Select the action(s) to be performed.

- n Wait for - enter a time in milliseconds, seconds, minutes or hours. The wait for action will delay the execution of further actions for the time defined.
- n Pause/resume the acquisition. Any incomplete timepoints will be completed before acquisition is paused.
- n Stop the acquisition. No actions added after this will be executed.
- n Change device - select a device name and configure the control to the state that the device is to be changed to.
- n Create an event - enter the label for the event. This label and the time will be recorded in the experiment log as well as being shown anywhere events are recorded.

More than one action can result from the condition(s) within a rule. Click + to add actions.

Multiple rules may be stored with an acquisition protocol.

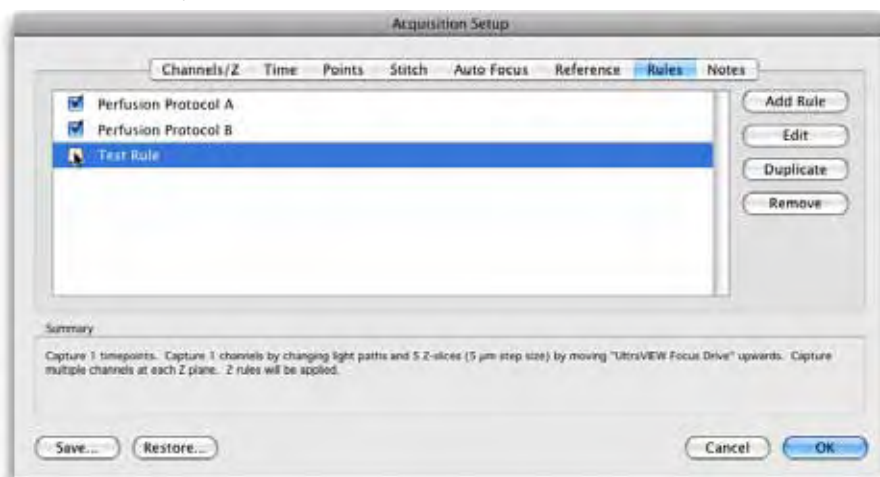

Checked rules in the list will be applied when the protocol is executed.

Acquisition Setup: Notes

The notes tab of the setup up dialog allows space for further information to be stored with the Acquisition protocol.

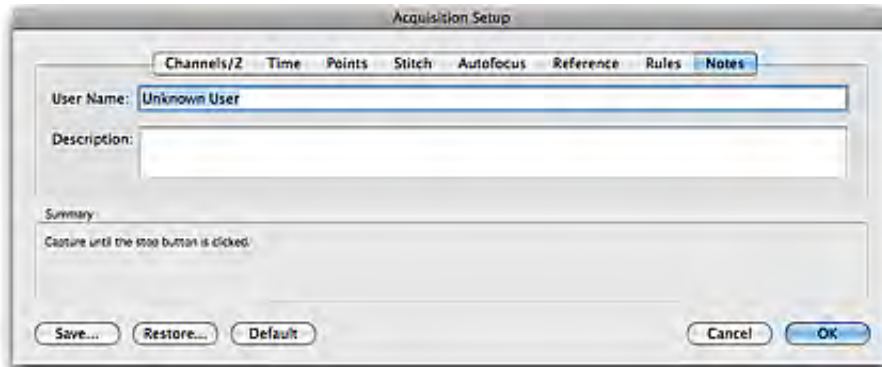

User name will be transferred to the properties of any item acquired using the acquisition protocol. Text entered in the description field is visible only in this location and may be used to store information about when to use the protocol or why it was created.

Saving Acquisition Protocol Settings

1. Click **Save...** on the Acquisition Setup dialog

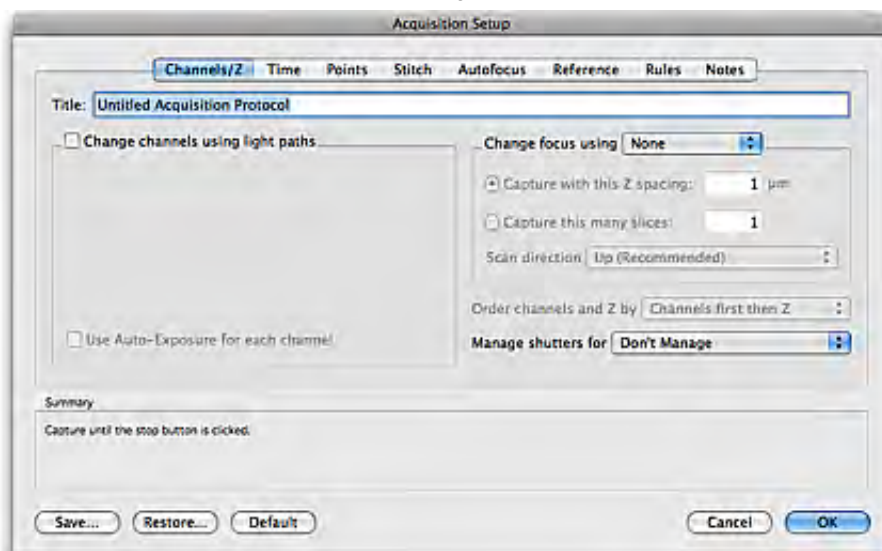

2. Enter a descriptive name for your acquisition protocol and click **Save**.

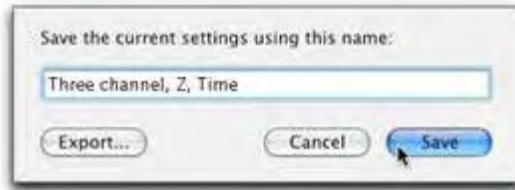

Note: You can also use this dialog to export settings, for example, if you wish to share those settings with a colleague.

Restoring Acquisition Protocol Settings

1. Click on **Restore...** on the Acquisition Setup window to display a list of saved acquisition protocols.

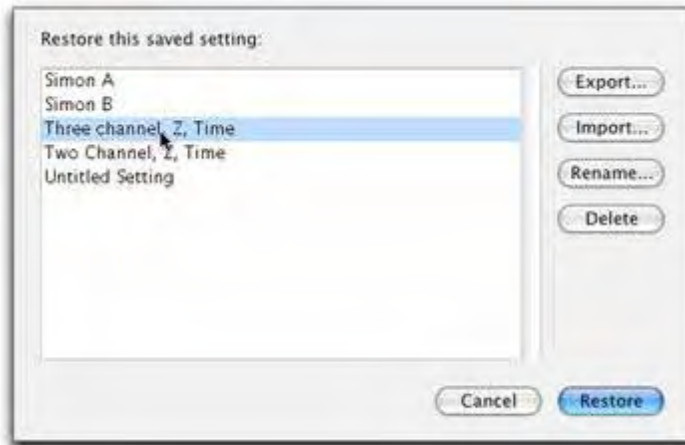

2. Select the protocol that you wish to restore and click **Restore**.

Capturing Image Sequences

Click the capture button to acquire an image sequence using the current acquisition protocol.

Once capture has started a red dot is shown on the Video Preview and the capture button changes to a stop button.



Click the capture button to acquire an image sequence using the current acquisition protocol.



Once capture has started a red dot is shown on the Video Preview and the capture button changes to a stop button.

The shortcut key F6 starts/stops the acquisition.



Capture a single frame of your acquisition protocol at any time. The space bar will also capture a single frame. To capture a single timepoint at the current XY position go to the Video menu and select **Capture Timepoint**.

If you have configured your acquisition protocol to acquire a fixed number of timepoints, the protocol will stop when the correct number of timepoints has been acquired. If you wish to stop the protocol before the end is reached, or if you have chosen the **Capture until stop is pressed** option, you must click the Stop icon on the Video Preview window.

You may re-run your acquisition protocol by selecting the Capture icon as many times as you wish.

Pause Acquisition while Capturing



You may pause acquisition by selecting the pause button during acquisition of an image sequence.

Any timepoints that have been partially acquired when you select pause will be completed before the acquisition is paused. Once partially acquired timepoints are completed no further acquisition will take place until the acquisition is resumed.

While acquisition is paused the pause button is highlighted and the red record icon in the top left corner of the Video Preview window changes to a gray pause icon.

- n To resume acquisition click on the highlighted pause button.
- n To stop acquisition whilst paused click on the capture/stop button.

If a timepoint is overdue when you resume acquisition, it will be acquired immediately and at the time intervals that you have specified in the time-lapse options thereafter.

Freeze the Video Preview



Freeze the image being shown in the Video Preview. This has two effects:

- n When viewing a live image, an acquisition protocol is not running. Freezing the preview will leave the last captured frame visible on the screen but will close any shutters associated with the current light path. This allows an image to be viewed and evaluated without exposing the sample to further illumination light.
- n When an acquisition protocol is running, freezing the preview will not affect any of the settings controlled by the protocol but the preview will not update with each captured frame. This maximizes the resources available to the acquisition and can improve performance.

While the Video Preview is frozen, the snowflake icon and the text "Preview frozen" will be shown in the top left-hand corner.

Acquisition Feedback

The acquisition protocol feedback panel provides a graphical summary of the current acquisition protocol. Double clicking on the acquisition protocol feedback panel opens the acquisition setup dialog.



Multiple timepoints



Multiple timepoints and multiple Z sections



Multiple timepoints, multiple Z sections, and multiple channels

A more detailed summary is displayed in the acquisition feedback panel tooltip (move the cursor over the LCD display to see the tooltip).

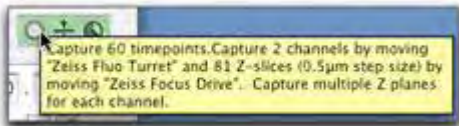

Click on the number in the timing feedback panel to toggle between the feedback modes. The display changes to show:



the elapsed time



the number of elapsed timepoints



the remaining time

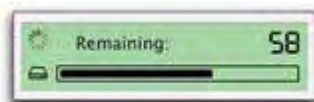

the number of remaining timepoints



the time until the next timepoint

Note: If **Capture until stop is clicked** was selected in the Acquisition Setup window, the **Remaining** option will display the approximate time or timepoints remaining until your hard disk is full.

Events and Logs

If something happens while observing acquisition that you wish to record, click on the Event flag.

click to record event during acquisition



Note: The shortcut key **F7** creates an event.

Enter the appropriate text to identify the event and click **Create**.

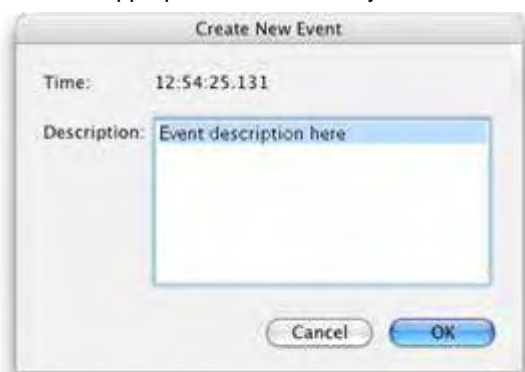

The text will be stored in the Experiment Log of the image sequence.

All of the image sequences that you acquire with Volocity Acquisition will have an Experiment Log View, which can be displayed by selecting the Experiment Log tab.

The settings that were used for acquisition and any events that you recorded during acquisition are recorded in the Experiment Log.

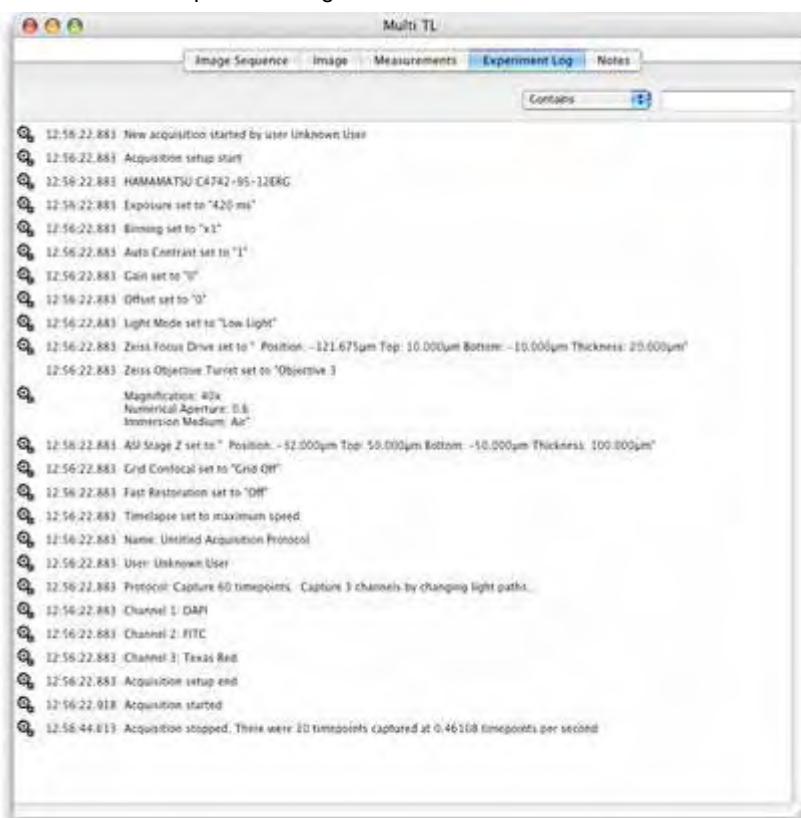

PerkinElmer UltraVIEW®

The UltraVIEW VoX is a complete system for live cell imaging using the CSU-X1 spinning disk head from Yokogawa®.

The system consists of:

- n CSU-X1 spinning disk
- n Emission filter wheel
- n Modular laser system
- n Piezo focus
- n CCD camera
- n Brightfield shutter
- n ProSync™ control box

Optional accessories include the PhotoKinesis™ accessory and a motorized XY stage.

How does the spinning disk illumination work?

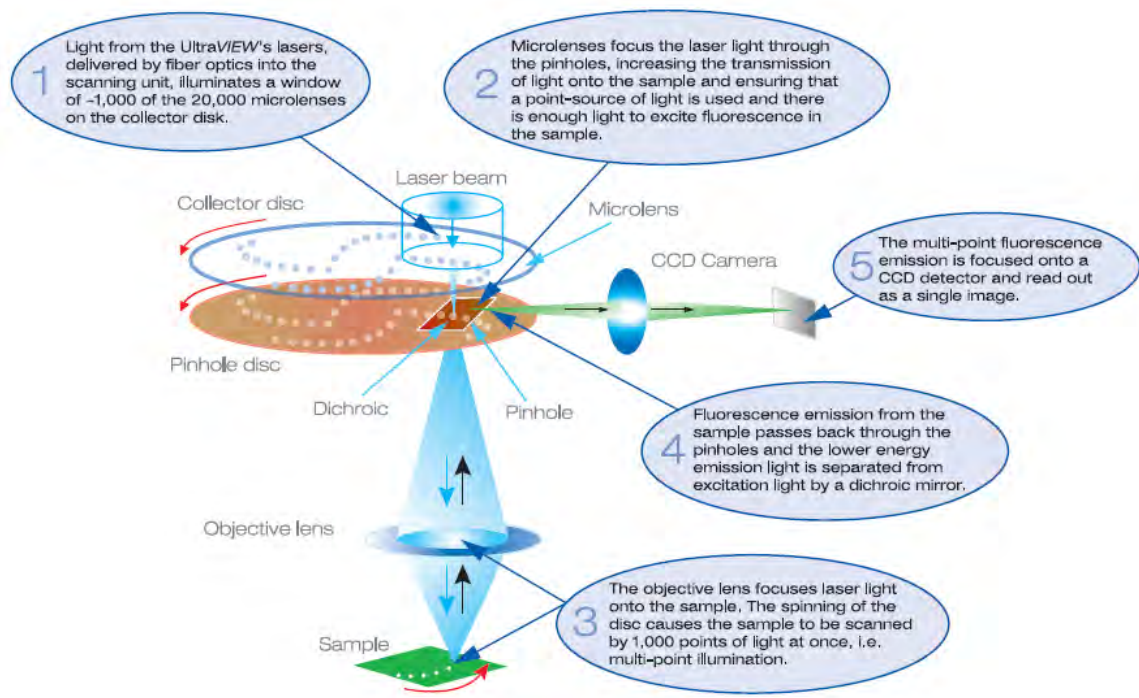

Configuring the Ultra *VIEW* in Preferences

For the hardware of the spinning disk device to be correctly identified and controlled in Volocity it must be configured in the preferences. There are two devices which communicate with Volocity via serial ports: Ultra *VIEW* Dichroic (within the CSU head) and the Ultra *VIEW* ProScan™ II Controller.

The following information assumes the hardware has been installed and aligned by a qualified PerkinElmer service engineer. These settings will also have been configured at installation but are provided here for reference.

1. Select **Preferences** from the Edit menu (Windows) or the Volocity menu (Mac OS). Choose **Serial Ports** from the list. The serial ports detected on the system will be listed and to connect a device in Volocity its name must be selected against the port to which it is physically connected.

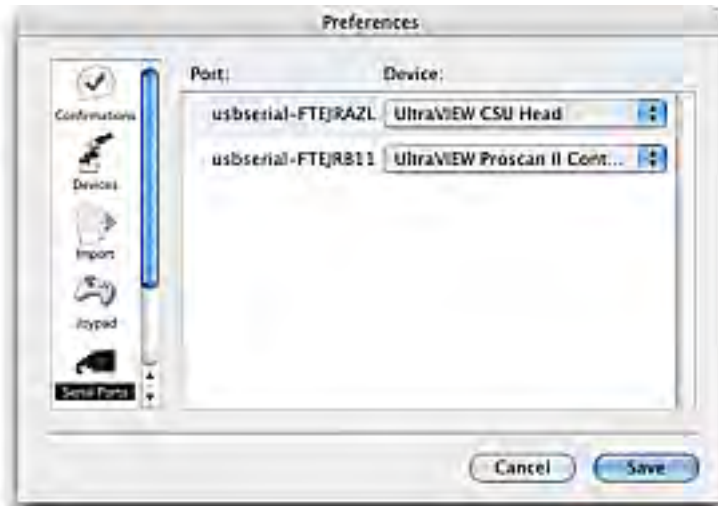

2. Scroll to the Devices pane and select the controls to be displayed in the Video Controls panel. Devices unchecked in this list will not be seen in the Video Controls panel and therefore cannot be controlled from that view.

Configuring the UltraVIEW in Preferences

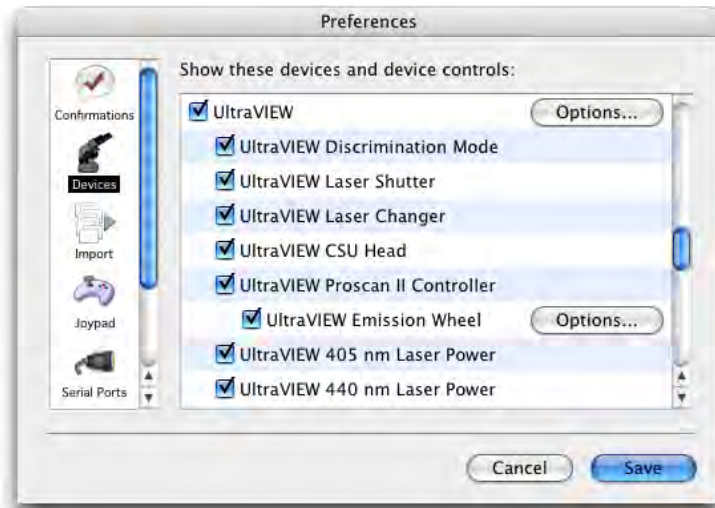

3. Next to the UltraVIEW item click **Options...** to configure the lasers present on the system. Select the UltraVIEW model from the list. Laser lines are not automatically detected.



Check the box next to laser line(s) that are present on your system. The 488 nm laser is standard on all systems; therefore, this option will be checked and cannot be changed.

4. Next to the UltraVIEW Focus Drive item click **Options...** to configure the range of travel for the piezo focus drive.



For the objective piezo drive this distance is 100 micrometers. For the stage insert this distance will be 200 micrometers or 400 micrometers. Check the specification of your particular system.

If the microscope focus is also controlled by Velocity it will have its own entry under the heading of the microscope. The piezo focus drive will be the fastest to use in experiments but the microscope focus might have a greater range of travel. Where both are available either may be chosen to acquire stacks in the Acquisition Setup dialog, which is used to configure the experiment.

UltraVIEW Controls

When the UltraVIEW is correctly configured in the preferences the following controls will be visible in the Video Controls. Select **Show Video Preview...** from the Window menu to see these controls and the live video.

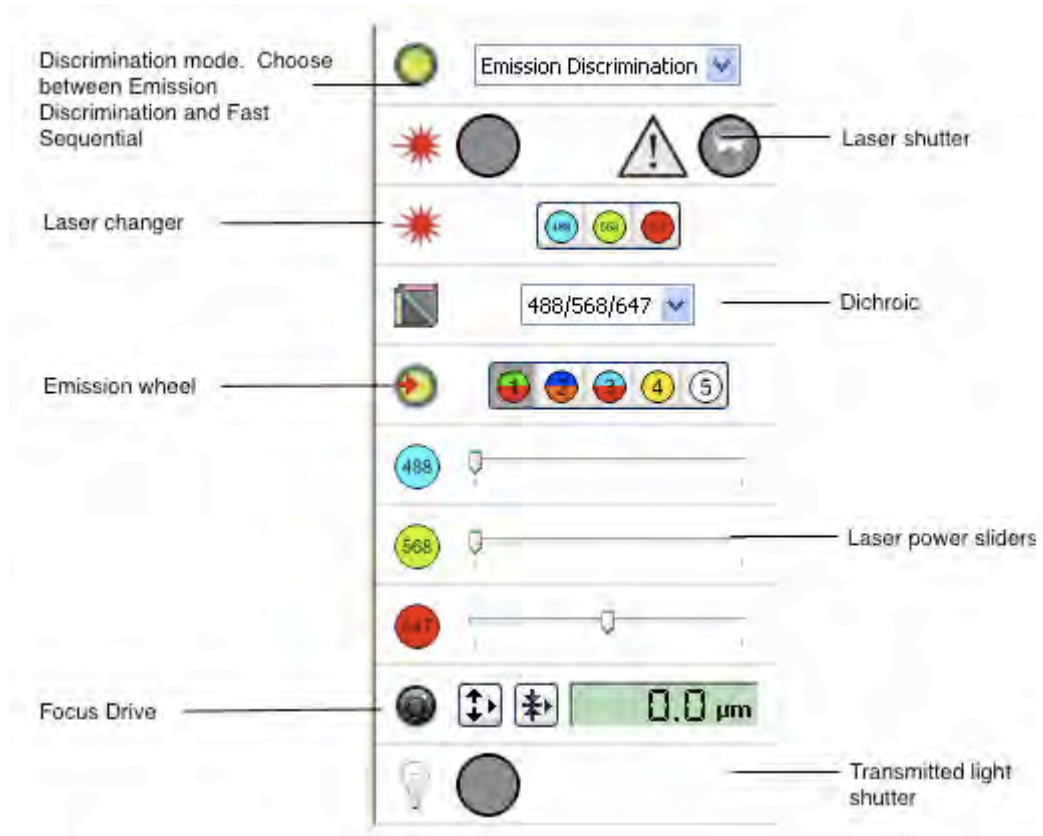

Discrimination Mode

When experiments are carried out using multiple wavelengths two different methods of capture can be used: emission discrimination or fast sequential.

Emission Discrimination mode will restore the emission filter wheel position associated with the light path. Changing the emission filter provides better discrimination between different dyes in one sample. The disadvantage of Emission Discrimination is a reduction in capture speed, due to the time taken for the emission filter wheel to turn from one position to another.

In Fast Sequential mode the filter wheel is not moved during the experiment. Instead the wheel is automatically turned to the position containing the appropriate broadband barrier filter for the current dichroic to prevent laser breakthrough. Any emission filter wheel positions stored with light paths will be ignored in fast sequential mode. Fast sequential provides the highest capture speed, as switching between lasers is very quick. However, because the same broadband emission filter is used for all images, there is an increased risk of crosstalk between the emissions of different dyes.

The emission filter wheel position must be stored in the light paths that are switched between by the acquisition protocol for emission discrimination mode to work correctly.

Dichroic

Switch between the dichroics installed in the CSU head using this pop-up. Some dichroics are only compatible with specific laser lines. This will be indicated in the interface as the lines that are not compatible with the current dichroic are grayed out.



Laser Power

One laser power slider will be shown for each line configured in the preferences. The higher the power used the more excitation light will be sent to the sample. This may increase the emission signal allowing shorter exposures to be used, however it will also lead to faster photobleaching and possible phototoxic effects.

Preparing to Use the Ultra *VIEW* in Volocity

In order to use the Ultra *VIEW* with Volocity all hardware must be configured.

- n Components of the Ultra *VIEW* which connect via the ProSync controller and serial ports must be connected, switched on and configured in the Volocity preferences.
- n Camera drivers must be installed, the camera connected and switched on. The camera will then be automatically recognized in the Devices list in the Volocity preferences.

If using a motorized microscope that must be connected to a serial port on the computer, use the serial cable supplied by the manufacturer. If there are no spare serial ports, it may be necessary to use a serial adapter.

Choose **Show Video Preview...** from the Window menu to see the image from the camera and the controls for the devices.

To ensure images are correctly calibrated set calibrations for each lens position. Calibration is then applied to each image according to the lens in position when it is acquired.

Light paths may be created for each of the laser lines to enable easy switching between excitation and emission wavelengths for different fluorochromes. It is advisable to create light paths using the Emission Discrimination mode of the Ultra *VIEW*, and for each laser line set and store the laser line, filter wheel position and set the laser shutter to open.



These light paths will then work satisfactorily with both Emission Discrimination and Fast Sequential modes. Storing other settings with these light paths are a matter of personal preference and will vary depending on how the system is being used. See page 164 for information on configuring the light path manager.

If the image generated by the confocal head does not fill the full field of view, adjust the CCD active area using **CCD Active Area...** dialog accessed from the Video menu.

PhotoKinesis™ Accessory

If the optional PhotoKinesis accessory is included in the UltraVIEW system there devices listed in the Preferences.

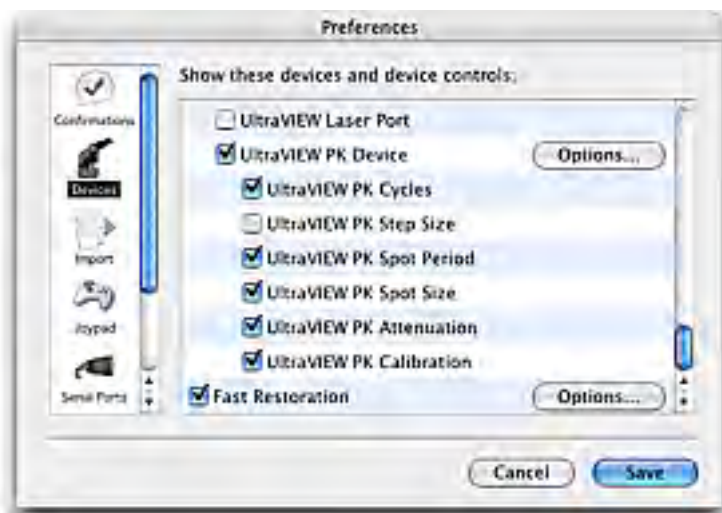

Click **Options...** to set laser power for bleaching. This dialog is also accessed from video controls while configuring an experiment.



PhotoKinesis Controls

Controls for the PhotoKinesis unit are displayed in the Video Previews including FRAP.

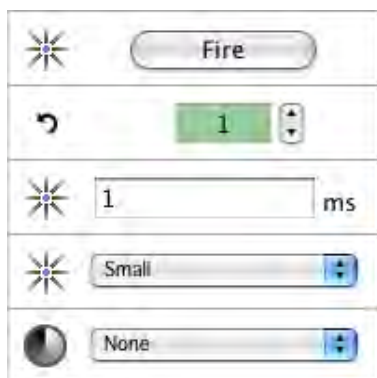

Use the Fire button to fire the bleaching laser at the selected power at any time. Double click on the icon for this control to configure bleaching laser power. The FRAP Acquisition setup dialog creates an experimental protocol that automatically fires the bleaching laser after the predetermined pre-bleach images have been acquired however in other experiments such as photoactivation or photo uncaging firing the bleach laser manually may be required. The keyboard shortcut for firing the laser is 'B'. In the Video Preview it may be applicable to configure an acquisition protocol to capture images at defined time intervals and manually fire the laser at some point during this.

Use the Cycles control to repeat the bleach scan over a region. More cycles with lower laser powers better achieve the depth of bleaching required with less cell damage.

Use Spot Period to define the length of time the spot will be bleached for. Use the Spot tool in the FRAP Preview to mark spot locations.

Use Spot Size to select between three spot sizes available. Actual spot size in the image plane will depend on the optics of the system and is measured during calibration.

Use Attenuation to move filters into the bleach light path to attenuate bleaching laser intensity.

Use Step Size (not displayed by default) to change the spacing between lines scanned when scanning a region. When bleaching or activating within a large region of mobile molecules higher step sizes and high bleaching laser power may achieve deep bleaching of the region more quickly than smaller step sizes.

Calibrating the PhotoKinesis Accessory

1. Select **FRAP Preview** from the Window menu.

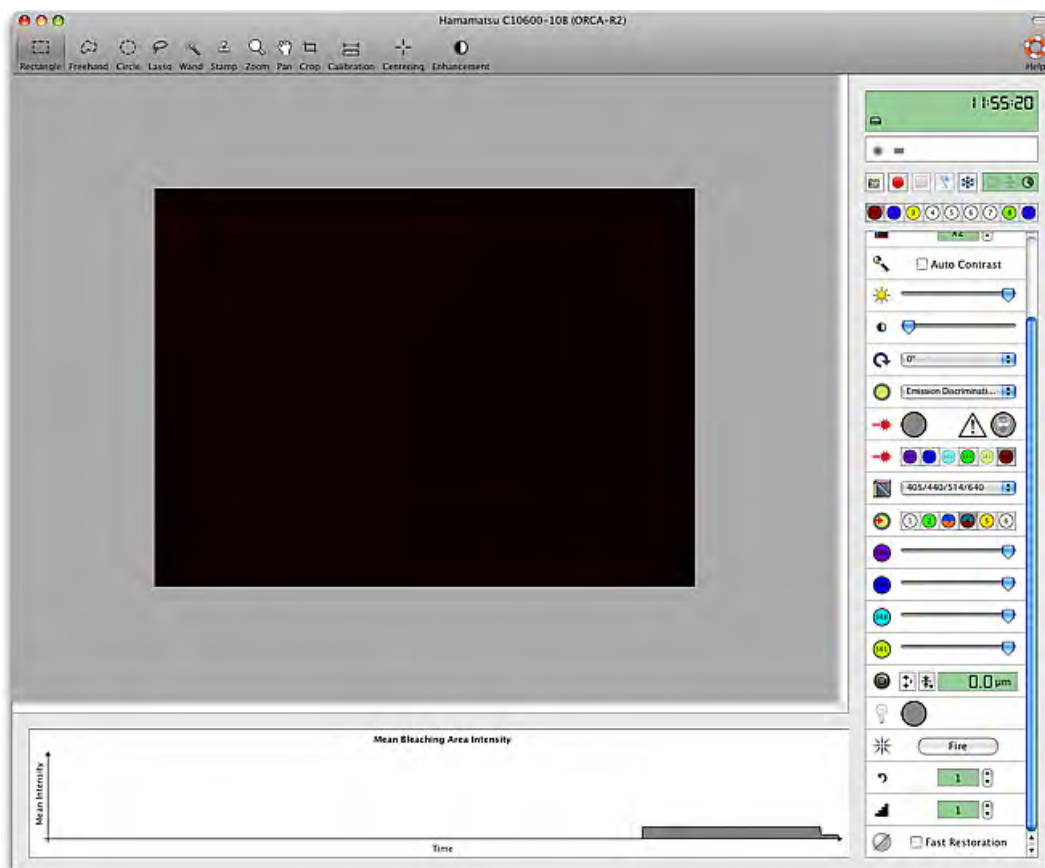

5. Select **Calibrate UltraVIEW PhotoKinesis Device...** from the FRAP menu.

The calibration wizard runs.

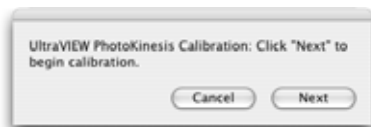

6. Follow the instructions and the calibration will run automatically. A spot of laser light will be imaged and moved to all edges of the field to complete a coarse calibration. The next step, fine calibration, requires a sample to image. This works best with a homogenous specimen such as ink from a

highlighter pen, allowed to dry. Stick a coverslip over the dried ink to best reproduce the imaging conditions of the sample.

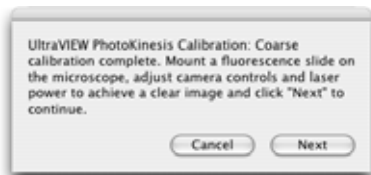

- When the specimen is in focus and the image is clear on the screen, click **Next**.

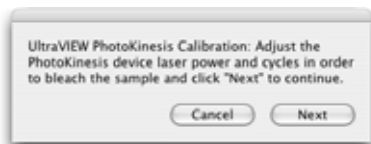

- To determine the laser power and number of cycles required to bleach the calibration sample it may be necessary to test bleach by drawing an ROI and using the **Fire** button to see whether the sample is bleached.



- Do not be concerned if the ROI and the resultant bleach area are not perfectly aligned, fine adjustment is performed in this step. Click **Next**. Volocity will bleach a specimen area and adjust accordingly.

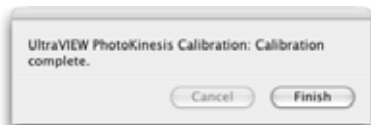

- Click **Finish**. The calibration is completed and you may wish to perform a test bleach.

If the calibration is not able to run automatically you will be asked to adjust camera and laser settings to achieve a well-formed spot and to ensure that the spot is approximately centered in the field. The spot is formed by the laser light reflecting off the calibration mirror in the PhotoKinesis unit.

Double click on the bleaching device icon in the interface to access the dialog to insert attenuators and move the position of the spot in the X and Y axes.

Calibrating the PhotoKinesis Accessory



Click **Finish**. The calibration wizard will close and you may wish to test the calibration.

If the system is fitted with a second camera the FRAP calibration process must be repeated for both cameras so that both may be used for FRAP experiments. The FRAP calibration is stored with the camera setting.

Testing Calibration

1. Draw an ROI in the FRAP preview, using the ROI drawing tools from the toolbar.
2. Click **Fire** and check the accuracy of the offset. If the region drawn is not matched by the bleached shape you may need to repeat the calibration process using different settings.

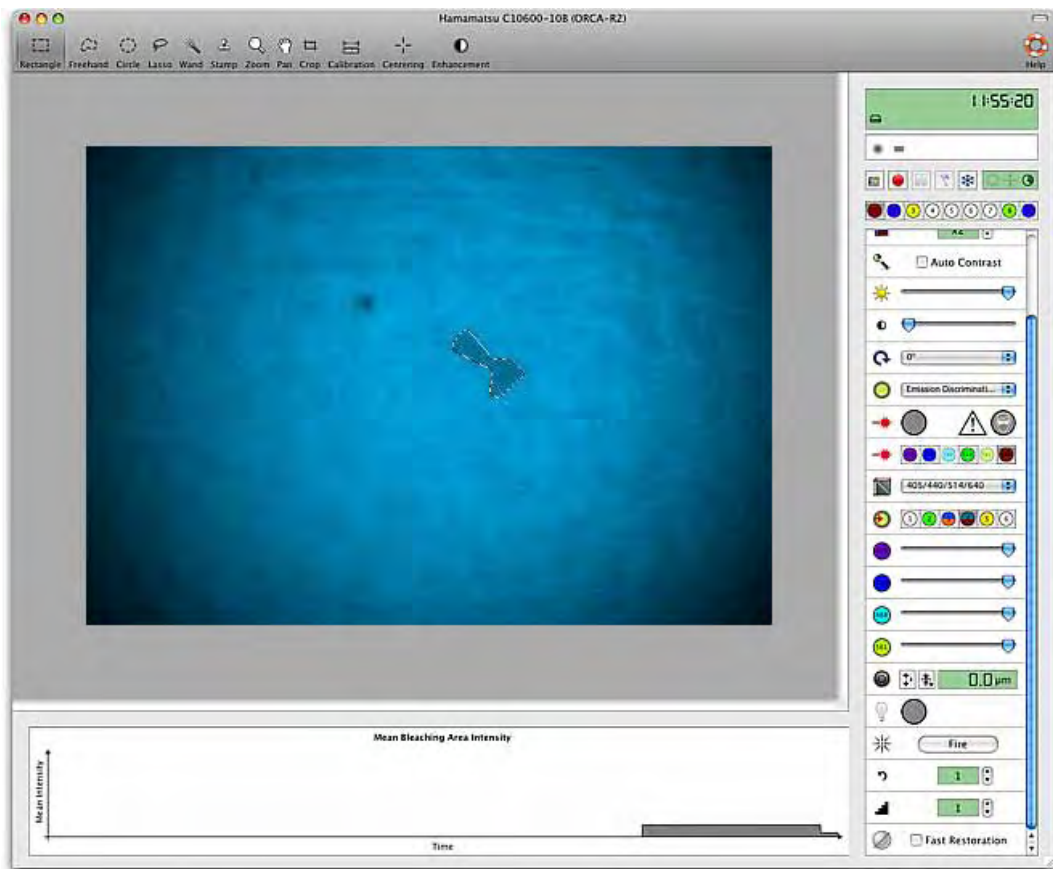

XY Stage, Multi-Point Acquisition Process

This section describes how to use Volocity to carry out multi-point acquisition using a motorized XY stage.

There are several steps to this process:

- n Set up and calibrate the XY stage.
- n Create overlays and scans.
- n Find specimens of interest and record their positions as “Acquisition Points”.
- n Set up the acquisition protocol and capture the image sequences.

Set Up and Calibrate the XY Stage

The XY stage must first be configured as a device in the preferences. See page 150. Once the stage is configured normal day to day operation will commence at step 5 below.

Note: Each time you start Volocity or turn the stage controller on, and are planning to use the two together, calibrate the stage.

1. From the Edit menu select **Preferences...** Click once on the **XY Stage** option.



2. Select the appropriate **XY Stage Device** and correct **Focus Device** from the drop-down menus. The focus drive that you select here will be used to store the positions of your acquisition points; you may use a different focus drive for your acquisitions.
3. In the **Devices** section click on the **Options...** button and set the correct range of travel for the stage model.
4. Use the checkboxes to set the X and Y axes correctly and click **Save**.
5. Clear the stage area and select **Calibrate Stage...** from the Stage menu.

6. At the warning prompt, check the stage area is clear. When you are satisfied that neither your specimens nor your microscope (in particular your lenses) will be damaged by large stage movements, click **Continue**. Volocity moves the stage to the bottom right and top left positions to establish the full range of travel and current position of the stage relative to the range of travel.



XY Stage View

Once the stage is calibrated, Volocity provides a choice of views: the XY Stage view and the live Video Preview (described on page 167). In the XY Stage view the green area represents the full working area of the stage. The gray crosshairs represent your current position on the stage.

If you move the stage manually you will see the position of the crosshair change to reflect the movement; the X and Y coordinates of the stage will also be updated. You can quickly move the stage by selecting the ROI tool (Shortcut key, R) and double clicking on the point on the XY Stage work area to which you want the stage to move.

A small Video Preview is displayed in the bottom left hand corner of the XY Stage view. This allows you to navigate around the stage whilst seeing the current Video Preview. The Video Preview can be moved to any corner of the XY Stage view. To move the Video Preview to another corner of the XY Stage view, click and drag the video preview to its new location.

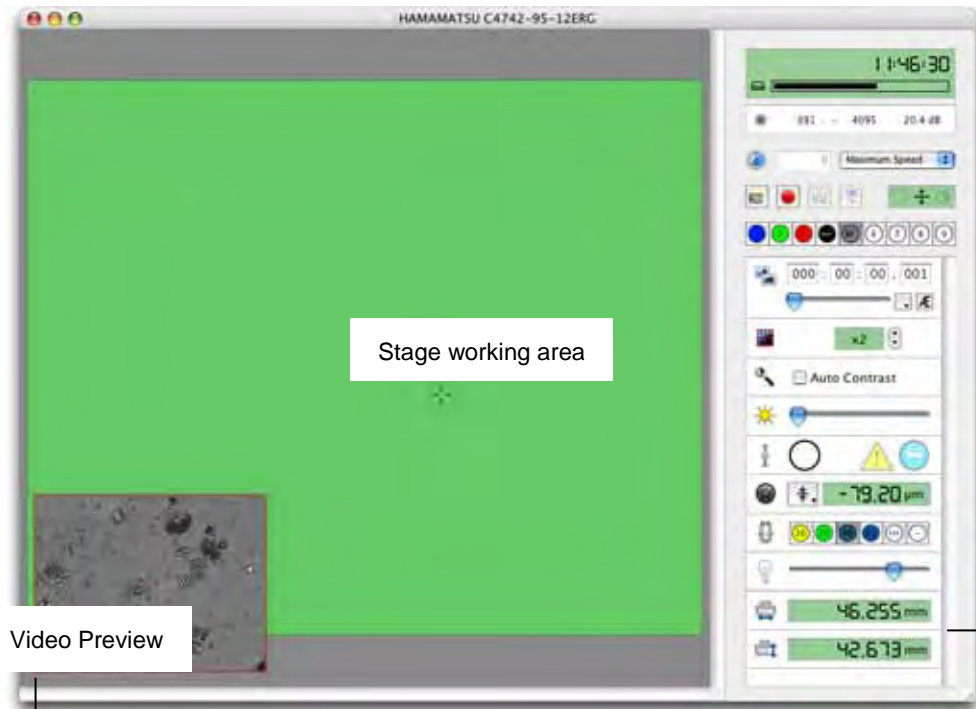

You may click and drag the preview to another corner

stage X and Y coordinates

You can toggle between the views by selecting the required view from the Video menu or by using the shortcut keys.

- n On a Mac:
Shift+Apple+V for live video
Shift+ Apple+X for XY stage
- n On Windows:
Ctrl+Shift+V for live video
Ctrl+Shift+X for XY stage

Adding Overlays

You can add overlays to your XY Stage view that will allow you to easily and quickly navigate around your culture vessels or slides.

1. Select **Make Well Overlay...** from the Stage menu.



2. Select the type of slide or culture vessel from the drop-down menu and click **Create...** Volocity now provides a wizard which guides you through the steps for setting the position of the XY stage.

In our example, we are making an overlay for a multi-well plate.

3. At each step of the wizard, move the stage to the requested position and click **Next**.



XY Stage, Multi-Point Acquisition Process

After the last requested setting has been entered, the wizard closes and an overlay is shown on the XY Stage view. Again, the cursor shows the current position of the stage.

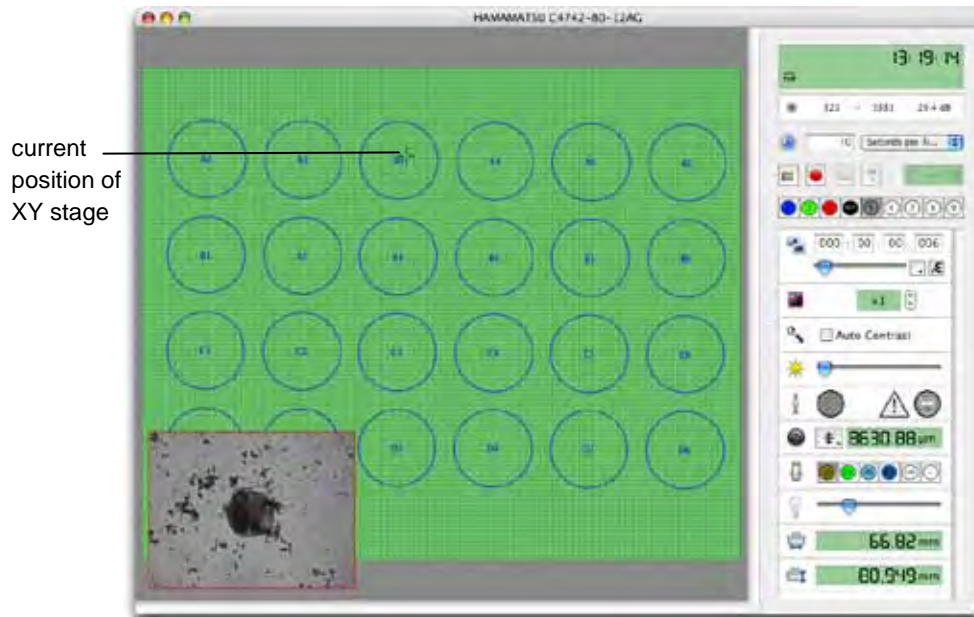

Once you have set up the overlay you can:

- n Move to a specific well. Select the ROI tool and double click within a well to move quickly to that well.
- n Select individual wells or groups of wells to work with. Use the ROI tool to select the required well(s) and select **Disable Selected Wells/Enable Selected Wells** from the Stage menu, as appropriate.

The following example shows three wells disabled.

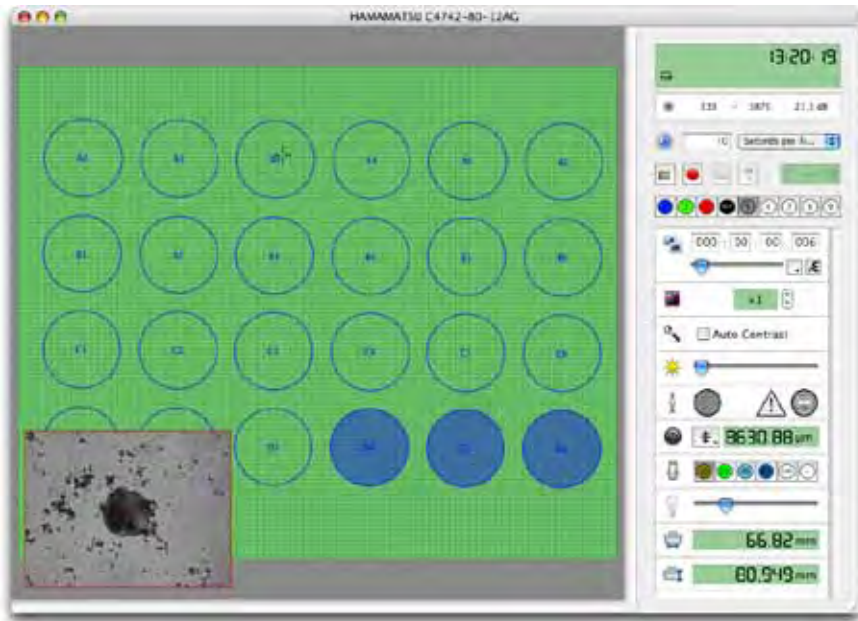

Saving and Restoring Overlays

To save overlays select **Save Overlay...** from the Stage menu. Enter a descriptive name for the overlay in the dialog that opens and select **Save**.



To restore a previously saved overlay select **Restore Overlay...** from the Stage menu. Select the overlay that you wish to restore from the list and select **Restore**. The overlay will be displayed in the XY Stage view.



Adding Points

Before adding acquisition points, we recommend that you focus on your specimen and click **Set Zero** on the focus drive slider (if you have more than one focus drive in your imaging system ensure that you reset the focus drive that you will use for your acquisition protocol).

You can add points manually or ask Volocity to create random points for you.

Manually Adding Points

1. Move the stage to the area of interest and focus on your specimen. You can do this by screening your specimen using your microscope's ocular lenses, or by using the Video Preview in Volocity to scan your specimen.
2. Select **Add point** from the stage menu or use the shortcut key:
On Mac: Shift+Apple+A
On WINDOWS: Ctrl+Shift+A
3. Move the stage and continue to add points manually, as required.

- The point is shown as a cross on the XY Stage view. The X, Y and Z co-ordinates are recorded with the point and displayed next to the point (you may have to zoom in to see the coordinates).

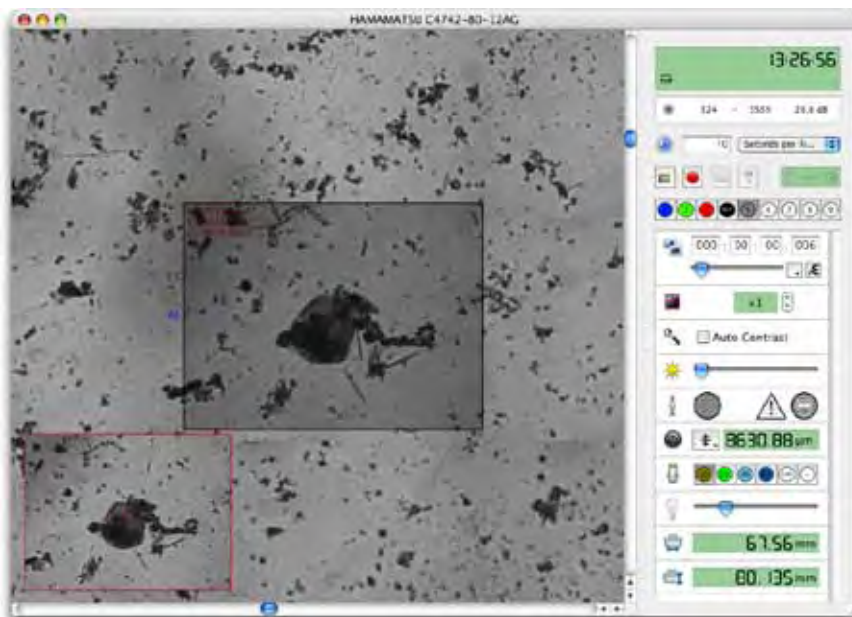

Creating Random Points

- Select **Create Points from Well Overlay** from the Stage menu.



- Select **Multiple Random Points** from the drop-down menu to add single acquisition points to random positions within each enabled well. Select **Multiple Tiled Points** from the drop-down menu to add a matrix of multiple points at the centre of each well. Specify the required number of **Points per well**.

3. Click **Create...**

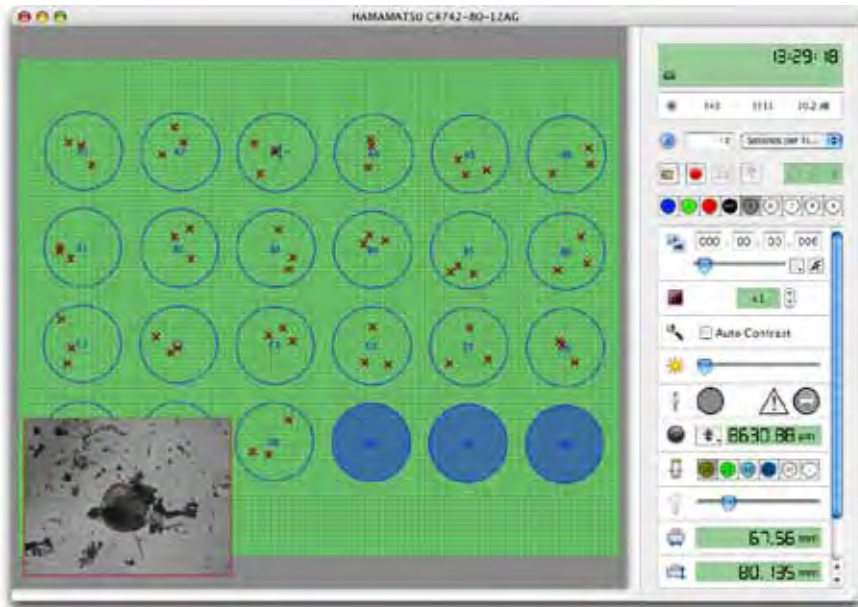

Inspecting and Editing Points

1. Use the ROI tool to double click on a point. This moves the stage and focus drive to the X, Y, and Z position of the point. You can use the **Go to Next Point** or **Go to Previous Point** commands or their shortcuts from the Stage menu to cycle through your points.
2. If you change the focal position of a point, select **Update Point** from the Stage menu.
3. If you have created a lot of points, use the **Review Points...** command on the Stage menu. The Review Points Wizard opens and takes you to each stored point.

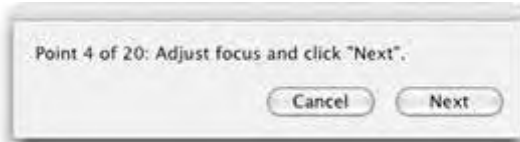

4. At each point you can review and edit the focal position. The current focal position when you select **Next** in the wizard will be stored with each point.

Focus Maps

If you have many randomly added acquisition points, you may find that manually reviewing each point becomes impractical, or that auto-focusing at each point is too time consuming, in which case

you should consider building a focus map. A focus map will allow Volocity to predict the surface topography of your cell substrate by sampling the correct Z position of a sub-set of your acquisition points. The number of points required to build a reliable focus map will depend upon several factors including the planarity of your substrate and the depth of focus of your objective lens.

Building a Focus Map

1. After adding your acquisition points, select Make Focus Map... from the Stage menu.

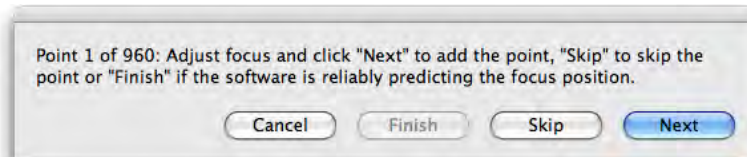

2. Volocity will move to the first of your acquisition points where you should either focus on your sample before clicking **Next**, or click **Skip** if there is no material in the field of view on which to focus.
3. Volocity will move to the most distant acquisition point, where you should again either focus and click **Next** or click **Skip**.
4. This process will be repeated until you click **Finish**. Each time Volocity moves to the next acquisition point it will attempt to predict the correct focal position of your sample. If Volocity is able to consistently correctly predict the focal position of your sample the focus map is adequate and you should click **Finish**. You should continue to add points to the map until this level of accuracy is reached.

Saving and Restoring focus maps

Focus maps are associated with overlays. If the current overlay is saved, the current focus map will be saved with it. Similarly, when an overlay is restored, the associated focus map is restored with it. After adding or restoring acquisition points to a restored overlay the focus map must be re-applied to the overlay at the correct Z position.

1. Select **Apply Focus Map...** from the Stage menu.

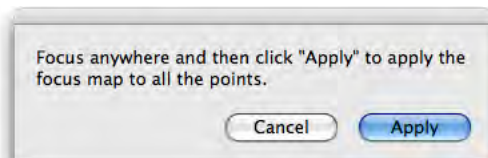

2. You should focus on your sample anywhere on your cell substrate and click **Apply** on the dialog that opens.
3. Your focus map should now be applied at the correct Z depth.

Saving and Restoring Points

To save a set of acquisition points, select **Save Points...** from the Stage menu. Enter a descriptive name for your points in the dialog that opens and select **Save**.



To restore previously saved acquisition points select **Restore Points...** from the Stage menu. Select your points from the list and select **Restore**.



Scanning

Note: Always make sure that the lenses are calibrated accurately and that the camera head is positioned squarely on the microscope before scanning. We also recommend that you enable binning on your camera prior to scanning; this will allow Volocity to scan fields of view more quickly.

You can set up scanning areas in three ways. You can scan regions of interest, whole wells from overlays, or you can scan acquisition points.

Scanning Regions of Interest

Set a region of interest by selecting the ROI tool, clicking and holding the mouse, and dragging out a region of interest on the XY Stage view.

You can also set an ROI in several steps by moving the stage to opposite corners of your ROI.

- n Move the stage to the top left hand corner of you region of interest and select **Set ROI Top-Left** from the Stage menu.
- n Move the stage to the bottom right-hand corner and select **Set ROI Bottom-Right** from the Stage menu.

Once you have set a region of interest, select **Scan Selected Area** from the Stage menu.

Scanning Enabled Wells

After making an overlay and ensuring that only the relevant wells are enabled, select **Scan Enabled Wells** from the Stage menu. Volocity will scan all fields of view within the enabled wells.

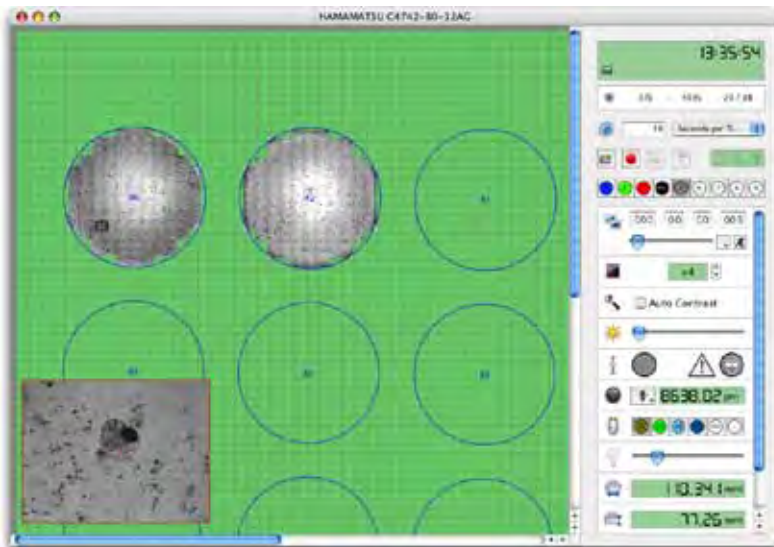

Use the zoom tool to zoom on scanned areas. This will help you to find areas of interest in your specimen.

Note: The shortcut key **Z** selects the zoom tool.

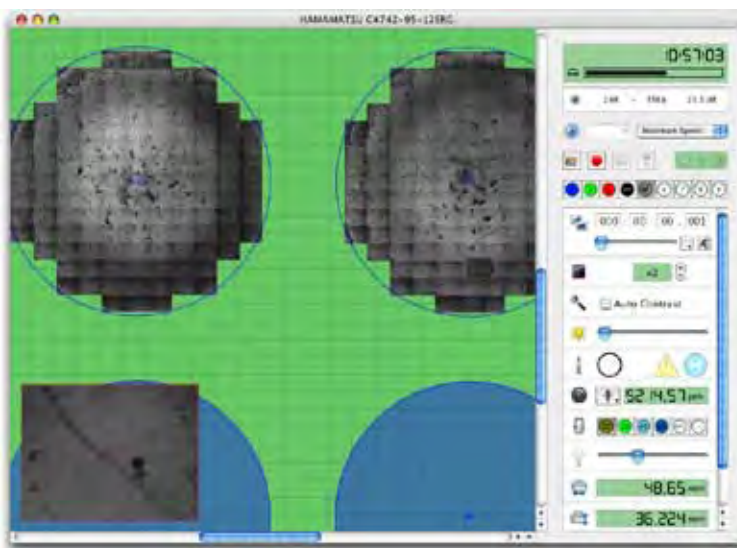

Scanning Acquisition Points

After you have added your acquisition points (see page 212) select **Scan Points** from the Stage menu. Volocity will scan your specimen and acquire a field of view for each of your acquisition points.

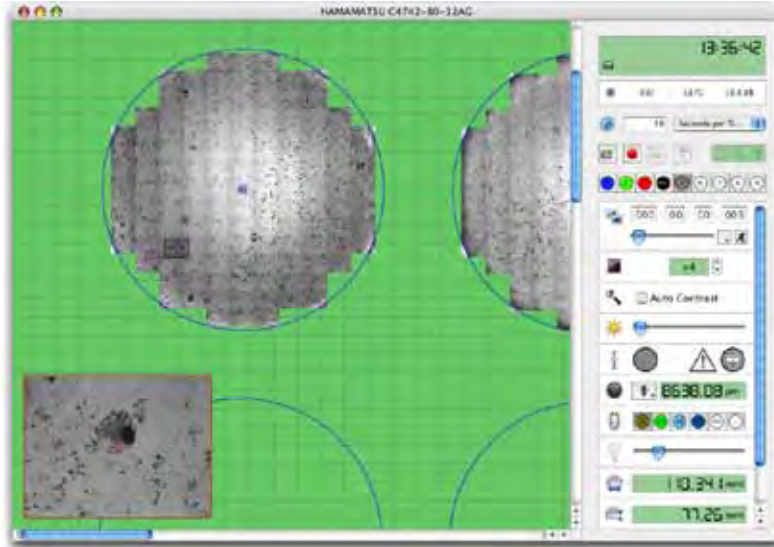

Capture snapshots of scanned areas by selecting **Capture Snapshot** from the Stage menu. Each well that you have scanned will be captured as a separate snapshot.

Note: The shortcut key **F5** captures a snapshot.

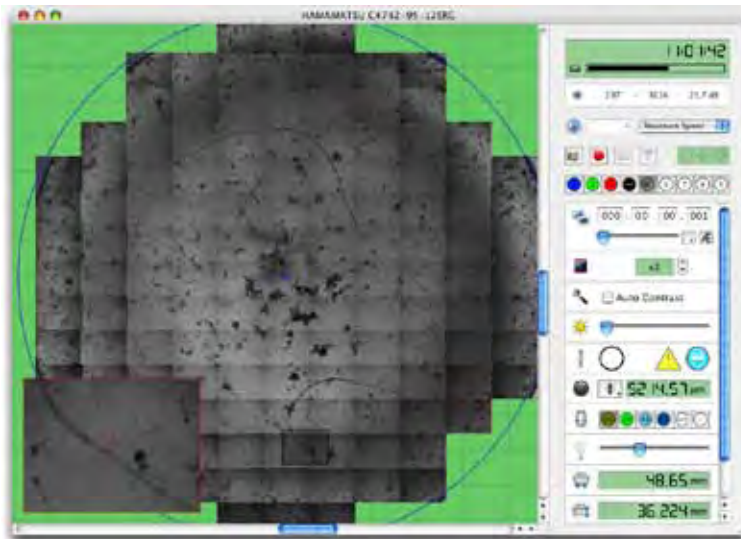

Set Up and Run the Acquisition Protocol

After storing points in the stage area, and creating a focus map if required, an acquisition protocol is used to image the points.

In the Video menu select **Acquisition Setup...** or double-click on the acquisition protocol feedback display on the Video Preview window. Select the **Points** tab.

Select an XY stage from the drop down menu to activate multi-point acquisition within the acquisition setup.

- n Configure the Channels/Z tab to capture more than one channel and/or a stack at each XY location, if applicable. Lightpaths and focus drive top and bottom positions must be stored in the Video controls.
- n Configure the Time tab to set timelapse and duration of the experiment to repeat the channel(s)/stack at each location multiple times.

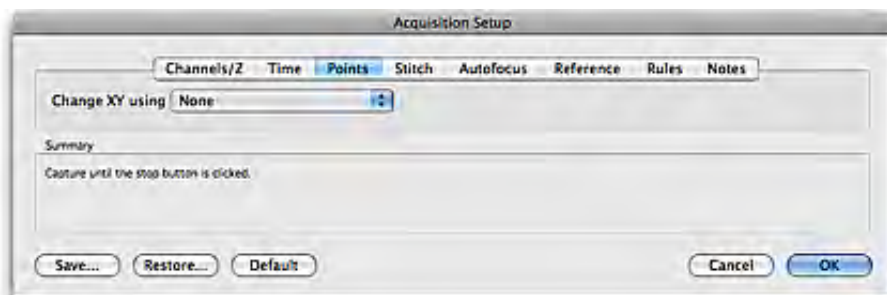

Configure other tabs as required. For details about a tab in the Acquisition Setup dialog see the section starting on page 173.

AutoFocus

If the system includes a hardware device to maintain constant focus such as a Perfect Focus, or Zero Drift device select the device from the pop-up. Volocity will activate the focus device to maintain the offset specified at the beginning of the experiment each time the autofocus is used. See the Volocity Supported Hardware list for details of such devices supported by Volocity and specific instructions for each supported device in the technical note library at <http://www.improvision.com/support>

When using one of these devices is not necessary to have the sample illuminated therefore the light path used for auto focus can be one in which shutters are closed or illumination intensity is low, this will protect the sample.

To use an image based auto-focus use one of the focus controllers on the system such as the microscope focus or piezo. Use the fastest focus device available on the system for best results.

Autofocus operates by seeking the highest contrast image when sampling within a range in the z-axis.

Select the light path that you wish to use for autofocusing from the drop-down menu. This must be a light path that generates an image but detected by the camera but to protect the sample could be a light path that is not acquired during the experiment such as one for Brightfield illumination.



If you choose to autofocus during the acquisition, you can also set timing options by selecting the “timing” icon.

You may choose to autofocus at each point, or at each well. If you choose to autofocus at each point, each point will have its own focus point. If you choose to autofocus for each well, all the points within a well will share a common focus point.



You may also choose to auto-focus for every timepoint, to only auto-focus for the first timepoint, or to auto-focus periodically.

Each of your acquisition points will be treated as zero, regardless of its actual Z value. So the distance between zero and your top and bottom position will be the same as the distances between each of your points and their top and bottom positions (see the tables below for examples). You can quickly check what values are set for top and bottom by inspecting the focus drive tool tip.

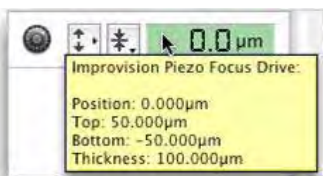

Top and Bottom marks with top set to 5 and bottom set to -5

Position (Z) of acquisition point (μm)	Bottom mark for acquisition (μm)	Top mark for acquisition (μm)
0	-5	5
10	5	15
20	15	25
30	25	35



Top and Bottom marks with top set to 10 and bottom set to -10.

Position (Z) of acquisition point (μm)	Bottom mark for acquisition (μm)	Top mark for acquisition (μm)
0	-10	10
10	0	20
20	10	30
30	20	40



If you wish to change the top and bottom positions, use the commands in the focus drive drop-down menu.

Note: You should avoid re-setting the zero value of your focus drive after setting your acquisition points. If you do so, you will invalidate the Z coordinates stored with each point.

If you have not set the top and bottom positions either side of zero, you may get the following warning.

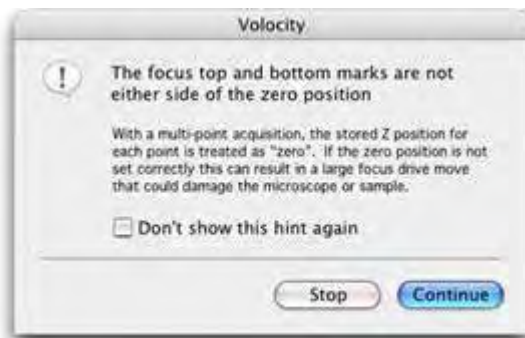

We recommend that when this warning is generated you stop the acquisition and check your top and bottom positions. In situations where the top and bottom are a long way from zero there is a danger that the focus drive may move long distances during the acquisition. This may result in damage to your microscope or specimen.

Velocity visits each acquisition point and conducts your acquisition protocol. The number of times Velocity visits each point is determined by the duration option that you set with the protocol, the frequency is determined by the time lapse option that was set on the Video Preview window.

Each acquisition point has its own image sequence. All the image sequences from a single multi-point acquisition are organized within a folder in your library.



FRAP Acquisition

Volocity provides full support for observing and analyzing the movement of intracellular materials after photobleaching of fluorescence. It supports both Fluorescence Recovery after Photobleaching (FRAP) and Fluorescence Loss in Photobleaching (FLIP) analysis.

FRAP Acquisition and Analysis functionality are provided by the FRAP plugin. This is an additional module available for purchase which extends the functionality of Volocity Acquisition to add features specifically for FRAP acquisition and extends the functionality of Volocity Quantitation for analysis of data acquired with the FRAP acquisition.

The FRAP plugin requires both Volocity Acquisition and Volocity Quantitation to function.

The FRAP Preview

This section describes features that are specific to the FRAP Preview window or are of particular relevance to the FRAP Preview window. Details of more controls that are common to the FRAP Preview and the Video Preview are described on page 167.

To display the FRAP preview select **Show FRAP Preview** from the Window menu or select the FRAP Preview icon in the library view.



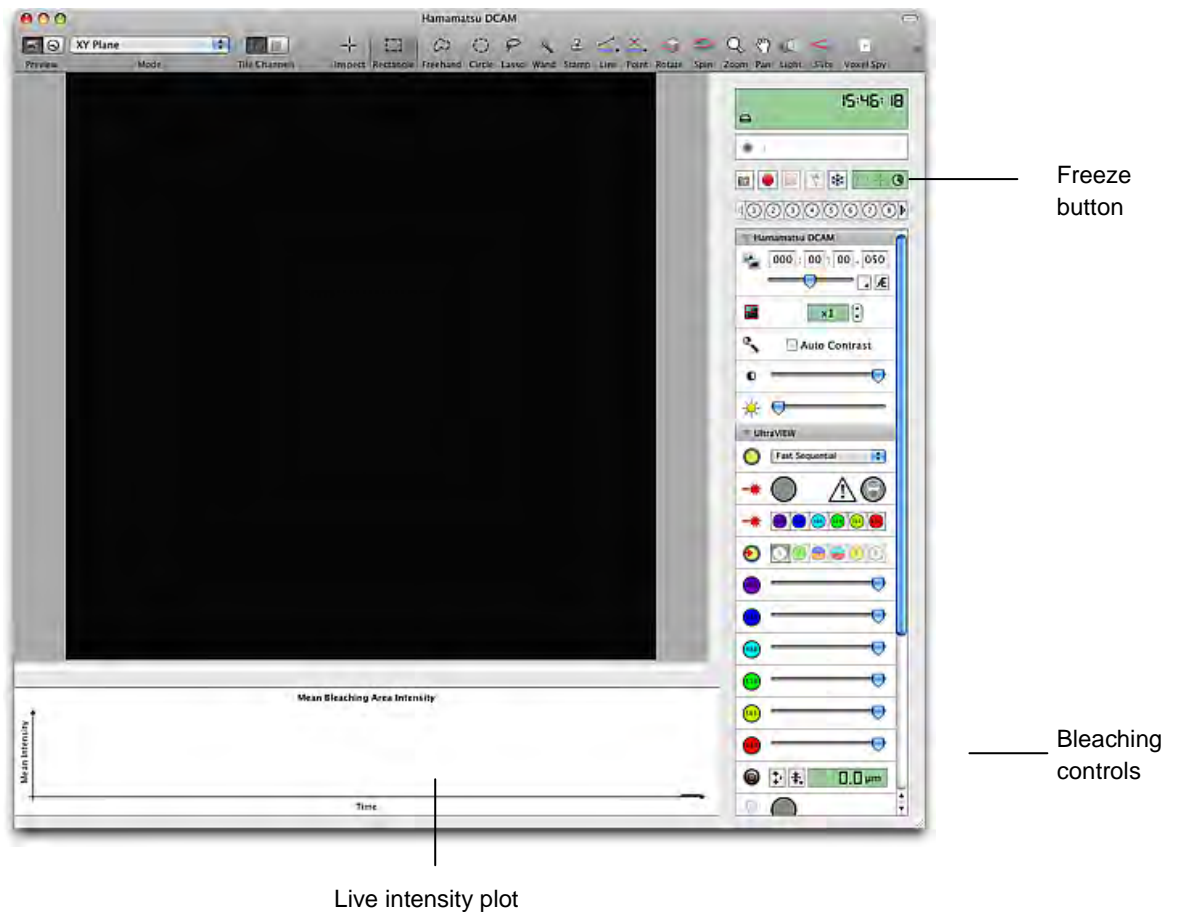

- n **Bleaching controls.** These may differ depending upon the type of bleaching device that you are using.
- n **Live Intensity plot.** This live plot shows the mean intensity of ROIs (or the mean intensity of the whole image if no ROIs have been selected). Prior to acquisition the mean intensity of all ROIs are shown in a single plot, during acquisition the mean intensity of each ROI is plotted individually. The Intensity plot is useful for assessing the level of photobleaching from the low intensity light source before acquisition, for adjusting the intensity of the high intensity light source, and for monitoring the progress of your experiment during acquisition.
- n **The Freeze button.** This allows you to “freeze” the Preview when you find an area of interest. Any shutters associated with the current light path are closed to prevent photobleaching, but the

last frame prior to closing the shutter is retained in the Preview. This allows you to select ROIs (bleaching areas) without illuminating your specimen, reducing photobleaching.

In the FRAP preview ROIs are used to mark regions that will be bleached during FRAP experiments. If your bleaching device supports spot bleaching bleaching regions may also be marked using the spot tool.

Preparing a FRAP Experiment

FRAP Acquisition is a plugin to Volocity Acquisition. If you are not yet familiar with Volocity Acquisition we suggest that you consult that part of the guide first

These steps assume:

- n that the bleaching device to be used is correctly configured and calibrated
- n that objectives are spatially calibrated
- n that light paths to be used for bleach, pre-bleach and recovery wavelengths are configured
- n and a FRAP acquisition protocol has been created.

Mount your specimen and expose it to your low intensity light source.

1. With your specimen in focus ensure that the all light is directed to your camera. You should see your specimen in the Video Preview. Adjust the camera controls until you are happy with your image.
2. You may wish to observe your specimen for a while to see whether you have an acceptable level of photobleaching from your low intensity light source, using the live intensity plot should help you make this judgment. If you make adjustments to your light intensity, remember to adjust your camera settings.
3. If possible, adjust the intensity of your bleaching device to the correct level. You should aim for maximum photobleaching without damaging or excessively heating your specimen.
4. When you are happy with the intensity of both your low intensity light source and bleaching device move to a new (unexposed) area of your specimen.



Select the Freeze button. The last frame previewed will be retained in the FRAP Preview.

Ensure that the shutter management in the FRAP Acquisition protocol is set to any option other than "Don't manage" and the shutter associated with the currently selected light path will be closed while the preview is frozen protecting the sample from illumination light while still allowing bleaching areas to be drawn. See Creating a FRAP Acquisition Protocol.

5. With the FRAP Preview frozen you can set the bleaching area for your experiment without photobleaching your sample. ROIs are used to mark bleaching areas. Use any ROI tool to draw an ROI or restore an ROI by selecting **ROI** then **Restore...** from the Edit menu. To set an ROI of a particular size we recommend the use of the ROI stamp tool. Information about drawing regions using ROI tools may be found on page 381.

6. If your bleaching device supports spot bleaching you can use the Spot tool to add spot targets to the video preview. You can add multiple spots by holding the SHIFT key whilst adding spots to the preview. Each spot will be bleached sequentially. Set the properties of spots (size, bleach duration etc.) using your bleaching device controls in the video preview.

Creating a FRAP Acquisition Protocol

1. Select **Acquisition Setup...** from the FRAP menu.
2. The FRAP Acquisition Setup dialog opens.

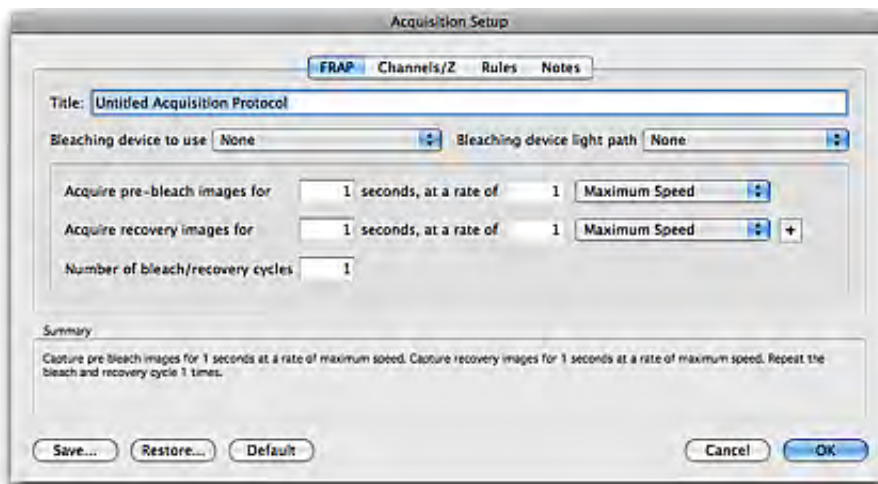

3. Select the bleaching device that you wish to use for the experiment from the **Bleaching device to use** drop down menu.

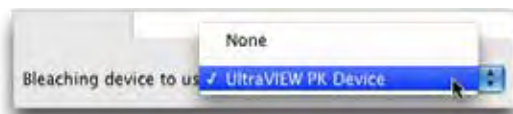

4. Select the light path that you wish to use for the bleaching phase of the experiment from the **Bleaching device light path** drop down menu.
5. If you wish to restore one or more light paths for your pre-bleach and recovery phases, select the **Channels/Z** tab and click on the **Change channels using light paths** check box. See page 174. If you wish to acquire more than one channel for these phases click on the "+" button to add more light paths. Select the appropriate light paths from the drop down menus. The same light paths will be used for both the pre-bleach and recovery phases of your acquisition. Using a different light path for bleaching from that used for pre-bleach and recovery will delay the switch between imaging and bleaching and vice versa.
6. In, **Acquire pre-bleach images for**, specify the duration and the frame rate of the pre-bleach period.



If it is not possible to determine the length of pre-bleach phase needed set this to a very long time period and use an acquisition rule to end the pre-bleach phase and trigger the bleach when an event occurs. Rules are configured in the **Rules** tab, events may be time dependent, based on keystroke by the operator waiting for the optimal time or based on a device reaching a particular state. See page 185.

7. In Acquire recovery images for, set the duration and frame rate of the recovery phase.

You may wish to set a very high frame rate for initial recovery period, but slow down the acquisition as your recovery approaches plateau in order to reduce photobleaching of your specimen. This can be achieved by setting a number of recovery phases.

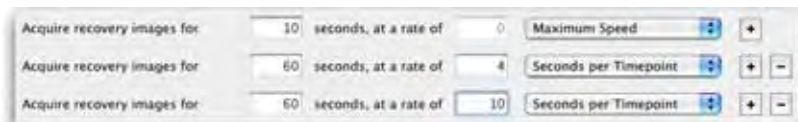

To add an additional recovery phase click the “+” button. Set the duration and acquisition rate of the new phase. You may add up to six different recovery phases as to your protocol. To remove a recovery phase click on the “-“ button.

In the example shown above an initial recovery period of ten seconds in which images are acquired at maximum speed is followed by a sixty second phase in which images are acquired every four seconds, which is followed by a final recovery period of sixty seconds in which images are acquired every 10 seconds.

8. Set the Number of bleach/recovery cycles. This will usually be set to 1 for FRAP experiments. With the number of cycles set to 1 the protocol will finish after completing the recovery phases. You may wish to repeatedly bleach your specimen, for FLIP experiments for example. With the number of cycles set to greater than 1 the bleaching and all of the recovery phases will be repeated. Note: the pre-bleach phase is never repeated.

9. Select the Channels/Z tab.

n For conventional FRAP acquisition and analysis you should acquire only a single plane. Ensure that **Change focus using** is set to None.

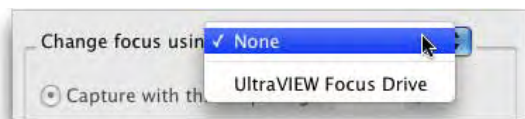

n Select a shutter management option from the **Manage shutters for** drop down menu. This must be set to something other than **Don't Manage** for the Freeze preview button to work correctly (see page 225).



10. When you are happy with your protocol click **OK**.

11. Click on the “Capture” video control to apply the acquisition protocol that you have just set up.

Velocity will carry out the pre-bleach phase, fire the bleaching device according to its configuration and continue with acquisition of the recovery images.

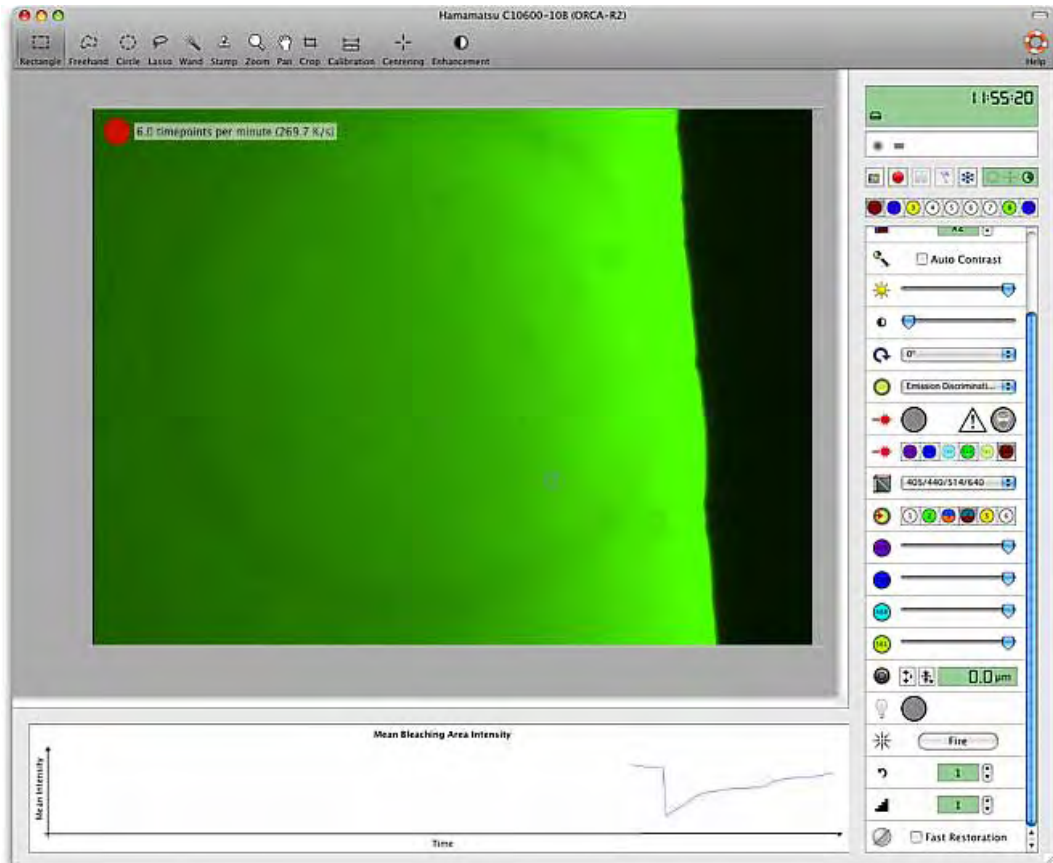

When acquisition begins ROIs change to colored “Bleach areas”, the intensity within a “Bleach area” is plotted in a matching color on the live intensity plot.

If you have set multiple ROIs on the Preview, which become multiple “Bleaching areas”, each is given its own color and plot when acquisition begins.

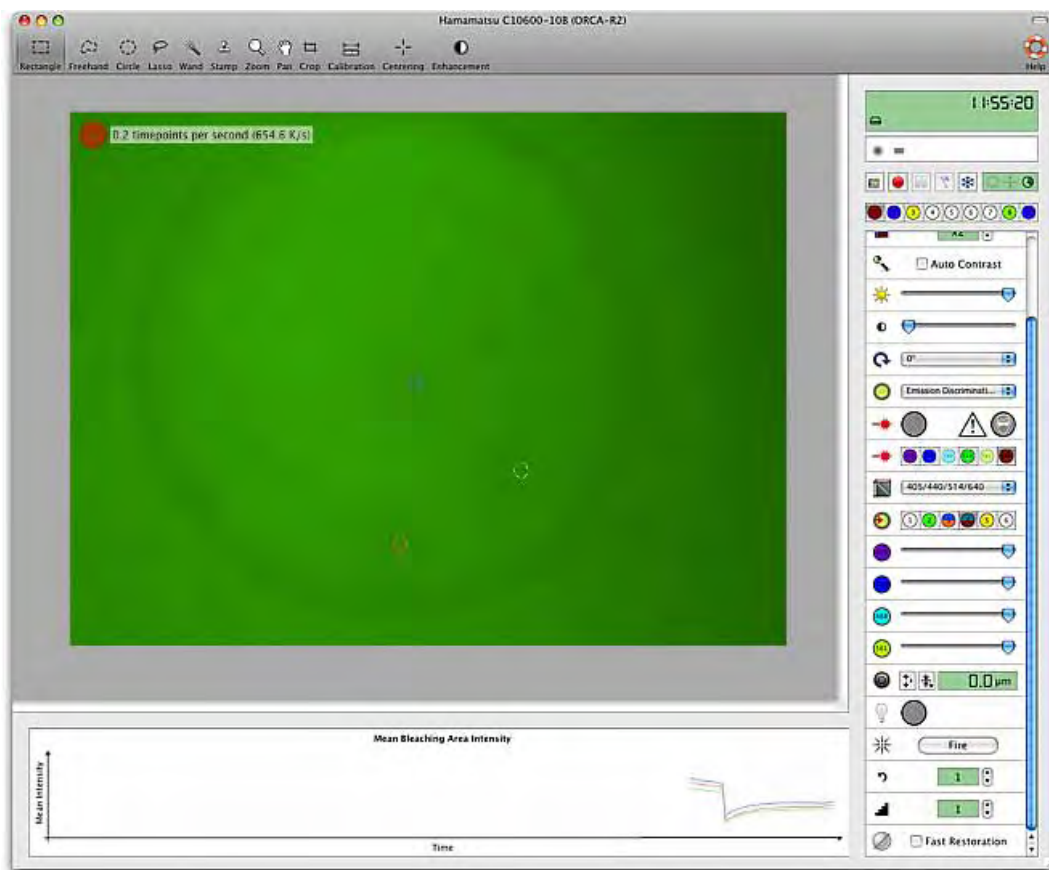

You can study the intensity of the bleached areas in the live intensity plot over the course of the recovery. When the protocol comes to an end the preview will be automatically frozen so that the final image of the recovery and the intensity plot can be reviewed. The plot and the FRAP preview will be overwritten when the preview is "unfrozen".

Your bleaching/recovery data is stored as an image sequence in your Volocity library, a channel is recorded for each of the light paths that you selected for the pre-bleach/recovery phases. Volocity also adds a template channel which records the positions of your bleach areas for analysis. Areas within the bleach area have a value of zero in the template channels, areas outside the bleach area have a value of 255. Volocity also records the time of the last frame before bleaching, and the first frame following bleaching as meta-data for analysis purposes. The experiment time is set to zero at the end of the bleaching phase, any frames acquired before this will have negative time stamps.

3D Targeted Illumination Experiments

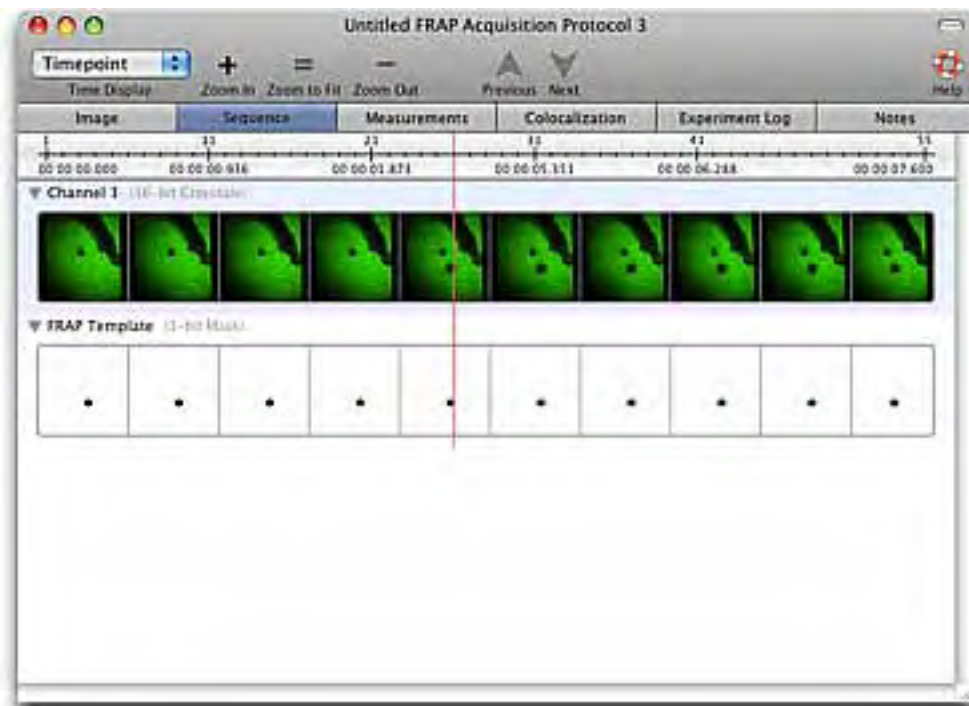

Data acquired with Volocity FRAP acquisition may be analyzed using the Volocity FRAP analysis.

3D Targeted Illumination Experiments

The FRAP acquisition protocol can be used to acquire volumes. You can run protocols that will apply your high intensity light source to a region of interest in a single plane within your volume.

The plane at or closest to the zero mark of your focus drive is the only plane that will be illuminated with the high intensity illumination.

We recommend that you set the plane to which you wish to apply targeted illumination to 0 (zero) in the focus drive control on the Video Preview.

The high intensity illumination will be applied between the pre-bleach and post bleach phases of your protocol.

Remember to set the focus drive's top and bottom limits to appropriate values.



In the FRAP setup dialog, **Channels/Z** tab, you must select your Z drive from the **Change focus using** drop down menu to acquire volumes.



FLIP Acquisition

FLIP is a technique that is also possible with the FRAP plugin. A FLIP experiment aims to determine whether molecules are moving between two areas or compartments of the sample and at what rate. To perform a FLIP experiment it is necessary to bleach one area and monitor another area which is thought to be connected to the bleached area. A control area that cannot be connected to the bleach area is also usually observed.

1. Select the FRAP preview from the Library view or **Show FRAP Preview** from the Window menu.
2. Mount your specimen and expose it to your low intensity light source.
3. With your specimen in focus ensure that the all light is directed to your camera. You should see your specimen in the Video Preview. Adjust the camera controls until you are happy with your image. You may wish to observe your specimen for a while to see whether you have an acceptable level of photobleaching from your low intensity light source, using the live intensity plot should help you make this judgment. If you make adjustments to your light intensity, also adjust your camera settings.
4. If possible, adjust the intensity of your bleaching device to the correct level. You should aim for maximum photobleaching without damaging or excessively heating your specimen.
5. When you are happy with the intensity of both your low intensity light source and bleaching device move to a new (unexposed) area of your specimen.
6. Select the **Freeze** button. Any shutters associated with your currently selected light path will be closed (provided you have opted to manage shutters in the FRAP preview). The last frame previewed before the shutter was closed will be retained in the FRAP preview.
7. With the FRAP preview frozen you can set your bleaching area for your experiment without photobleaching your sample. ROIs are used to mark bleaching areas. Use any ROI tool to draw an ROI or restore an ROI by selecting ROI then **Restore...** from the Edit menu. To set an ROI of a particular size we recommend the use of the ROI stamp tool.

8. Select **Acquisition Setup...** from the FRAP menu and set up the acquisition protocol.

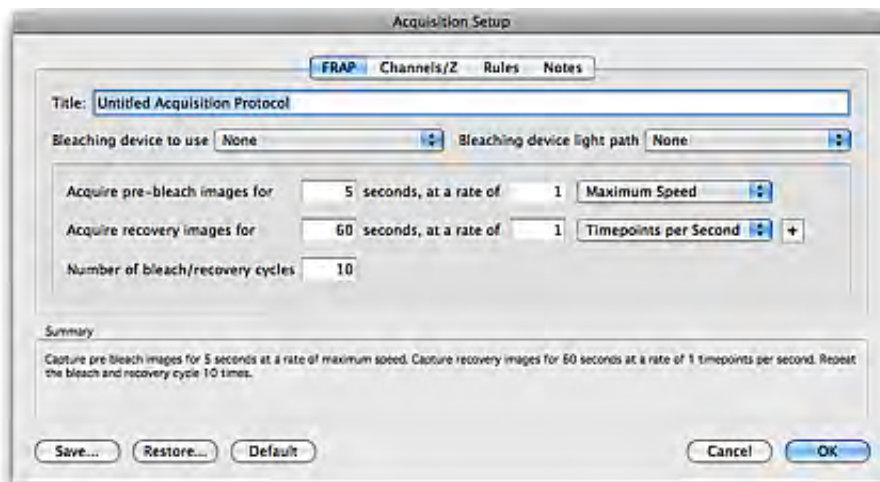

In this example, the bleach and recovery phase is repeated 10 times. Two images are acquired during the recovery phase, one immediately following the bleach and a second a minute after the bleach. Click **OK**.

9. The acquisition protocol is now stored and can be run by clicking the capture button on the FRAP preview.
10. The pre-bleach images are acquired only once, but the bleach and recovery will be repeated, in this case 10 times. These images may then be measured using the standard measurement tools in Velocity. An example of this is described in "FLIP Analysis" on page 481.

Ratio Acquisition

Volocity Ratiometric Acquisition is designed specifically for online ratiometric imaging. The Ratiometric Acquisition functionality is provided by the Ratiometric plug-in. This is an additional module available for purchase and extends the functionality of Volocity Acquisition to add features specifically for online Ratiometric Acquisition. The ratio is always calculated as Channel A/ Channel B and therefore it is important to specify the channels correctly in the Ratiometric dialog.

The Ratiometric plug-in requires both Volocity Acquisition and Volocity Quantitation to be installed to function. Ratio acquisition is followed by generation of a measurement item, measuring all active regions of interest in the experiment.

The Ratio Preview

This section describes features that are specific to the Ratiometric Preview window. Details of more controls that are common to the Ratiometric preview and the Video preview are described in the section on the Video preview on page 167.

To display the Ratiometric preview select **Show Ratiometric Preview** from the Window menu. The devices and device controls that were selected in the preferences are displayed on the right-hand side of the Ratiometric Preview window.

Features that are specific to the Ratiometric Preview Window include:

- n Ability to display 2 captured channels and 2 calculated channels simultaneously in a 4 panel multiview preview
- n Ratiometric acquisition controls in addition to standard Video Preview device controls.
- n The live ratio plot

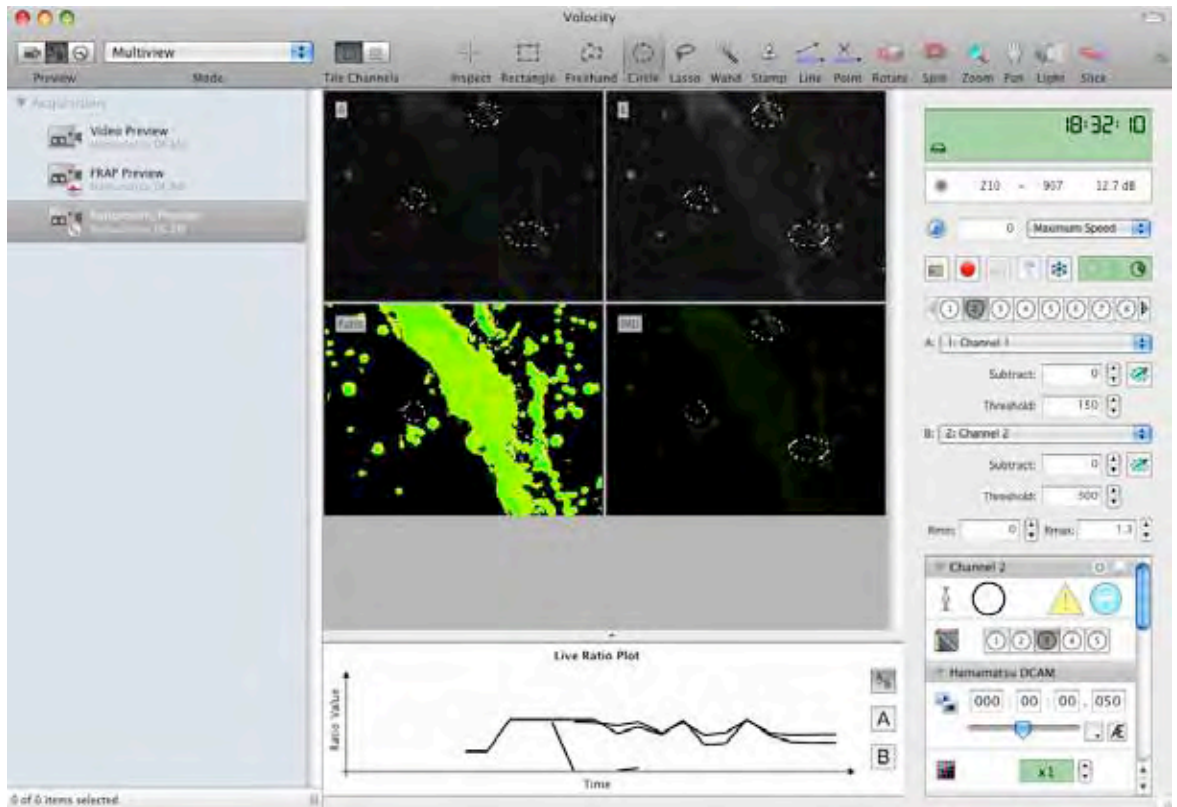

Preview



Preview frames. Frames are displayed individually each frame replaces the previous frame. Only XY plane mode is available.



Preview in multiview. Unique to Ratio preview. Show live previews of channels A,B, the ratio channel or the Intensity Modulated Display (IMD). Select one or all of these using the Mode pop-up.



Preview timepoints. Video Preview is updated as each timepoint is acquired. Available for live preview as well as during experiment acquisition. The current acquisition protocol will be used to generate the preview if it is not already running. An image sequence is only acquired if the system is recording. Previewing timepoints may not be suitable for photosensitive samples or samples which suffer rapid photobleaching. Since the acquisition protocol is used to determine what makes up a timepoint and will therefore be managing shutters it is necessary to switch to preview frames to regain control over shutters. Additional modes of display and tiled channels available when previewing timepoints. Choose to view any of the ratio previews plus any other modes supported by the system.

Mode

Change the mode of display for the Video Preview. Modes available will depend on Volocity products licensed for the system and on whether frames or timepoints are being previewed. When previewing frames only XY plane mode is available. Modes unique to the Ratio Preview are displayed when in the multiview preview. The choice to view the A channel, B channel, ratio channel, IMD channel or all four, the multiview is available.

The IMD channel is generated from the Ratio channel and another image. Select the modulating image from the **Ratio** menu, **Calculate IMD From**. For more information on IMD images see page 499.

Channel Display

Choice over channel display is only available when previewing timepoints.

- Overlay channels. Where two or more channels are previewed or captured they will be shown overlaid.
- Tile channels. Where two or more channels are previewed or captured show each channel as a separate tile in the view plus an overlay of all channels. Available for some modes of the preview such as XY plane and extended focus. If ratio image and/or IMD image are required in the preview use the multiview preview and select the mode required.

Ratiometric Acquisition Controls

The ratiometric acquisition setup pane contains dropdown menus for the selection of the correct light paths to be used for Channel A and B.

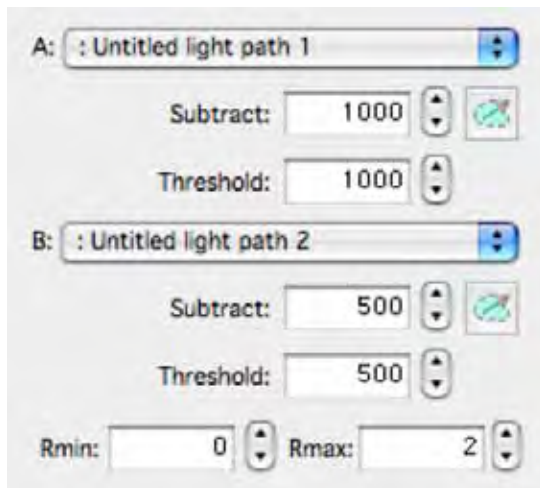

A constant background value may be subtracted from each voxel in every image of Channel A and/or Channel B. This can be done by either entering a value in the **Subtract** field or drawing an ROI on the appropriate image and clicking the get from ROI tool next to the Subtract field. Volocity will use the mean intensity from that ROI for each channel as the value to subtract.

Thresholding allows the removal of unwanted signals setting a ratio value to 0 when one of the source voxels has an intensity value at or below the threshold. Threshold values can be set for Channels A and /or Channel B by entering a value in the **Threshold** field.

The Ratio value range can be set by entering values in the Rmin and Rmax fields. These set the range over which the rainbow look up table for the image will be spread.

Live plot

The live ratio plot can show the mean intensity values of ROIs (or the mean intensity of the whole image if no ROIs are present) of either Channel A, Channel B and the ratio plot A/B if these respective channels are being previewed. The plots can be shown if the respective channels are being previewed whether sequentially or simultaneously as in multi-view mode. The mean intensities of Channel A and Channel B and the ratio plot can also be shown in the live plot when the IMD channel is being previewed.

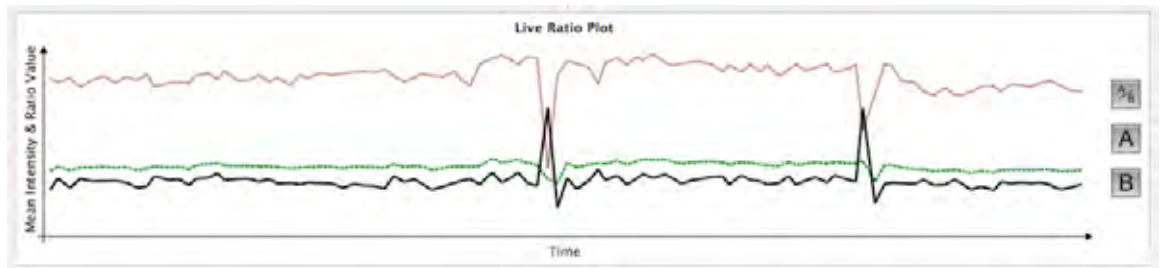

During live preview and acquisition you can choose to hide or show the plots using the toggle buttons to the left of the live plot panel.

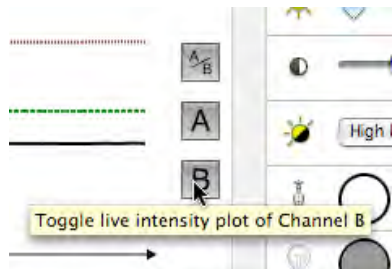

For easy identification during live preview the plots are color-coded as follows:

- n Mean intensity Channel A- same color as configured in the light path setup for Channel
- n Mean Intensity Channel B- same color as configured in the light path setup for Channel
- n Ratio Plot- black line

n Intensity plot lines are dashed and ratio plot lines are solid

The x axis of the live plot will rescale to ensure the full course of the experiment is displayed.

Preparing a Ratio Experiment

Ratiometric Acquisition is a plug-in to Volocity Acquisition. If you are not yet familiar with Volocity Acquisition please refer to 'Volocity Acquisition Installation and Reference' on page 149.

Before starting a Ratiometric experiment:

1. Install and configure all devices that are required for Ratiometric acquisition.
2. Calibrate each objective lens, if they are not already calibrated
3. Mount your sample and view using your low intensity light source.
4. Select **Ratiometric Preview** from the Library view or **Show Ratiometric Preview** from the Window menu.
5. Configure any light paths that you require for Ratiometric acquisition. You will need one light path for Channel A and another for Channel B. Select these lightpaths as the A and B channels in the acquisition controls.
6. Configure any additional light paths you will need to image during the experiment.
7. To populate the background subtract field for Channel A draw a ROI in the background of the live preview image of select Channel A and click the Get from ROI button next to the subtract field for Channel A.
8. Similarly for Channel B draw an ROI in the background of the live preview image of Channel B and click the Get from ROI icon next to the subtract field for Channel B.
9. Set the threshold values to ensure a black background.
10. Set Rmin/ Rmax to expected or known values for the experiment.

These settings will be used for this experiment but data acquired using the ratio acquisition may also be reprocessed using the Ratio dialog in Volocity Quantitation.

After performing several experiments you may determine values for Rmin and Rmax which you use for all experiments allowing them to be visually compared and avoiding the need for post processing.

11. Create an acquisition protocol.

Creating a Ratio Acquisition Protocol

1. Select **Acquisition Setup...** from the Ratio menu.
2. The Acquisition Setup dialog opens at the specialized Ratio tab.

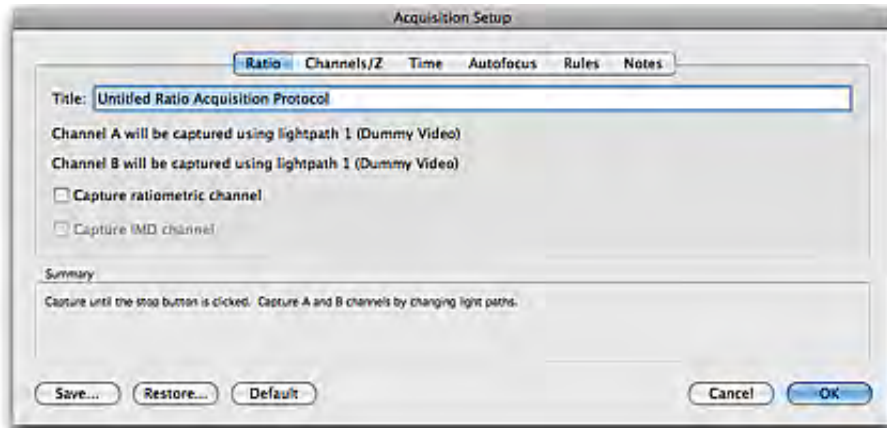

3. If you want to acquire the ratio channel and /or IMD channel tick the appropriate channel check boxes. You cannot collect an IMD channel without capturing the ratiometric channel.

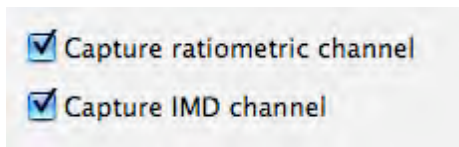

4. Select the **Channels/Z** tab. Select a shutter management option from the **Manage shutters for** drop down menu.

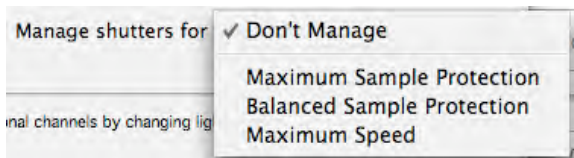

5. If you want to acquire any additional channels tick the **Capture additional channels** check box and use the drop-down menu to select the additional light paths to be captured.

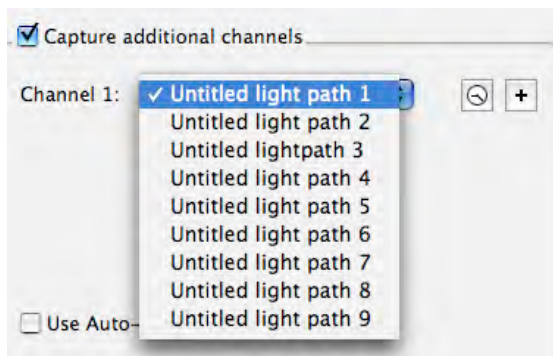

If you would like to acquire more than one additional channel click on the '+' button and add more light paths.

6. If you want Volocity to set the exposure for each of your light paths check **Use auto exposure for each channel**.

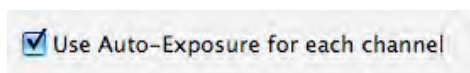

7. Select the **Time** tab. Choose the rate of acquisition. This may also be changed using the field on the Video controls. Set the duration of the experiment, either the Until stop is clicked where Volocity acquires data until it is manually stopped, or enter a number in the text field and select either 'timepoints', 'ms', 'seconds', 'minutes' or 'hours' from the drop-down menu.

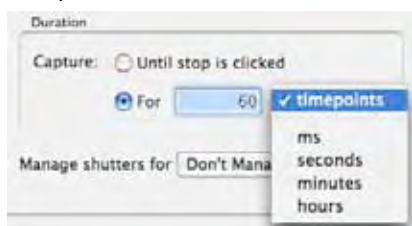

8. When you are happy with the ratio acquisition protocol click OK.
9. Click on the Capture video control in the Ratio preview to apply the acquisition protocol that you have just set up.

Note: A Volocity library must be open to store the image sequences that are acquired.

Volocity will acquire the appropriate images, freeze the Video Preview so that the last frame acquired is held on the screen, and then automatically start generating a measurements item. See Viewing Results on page 241.

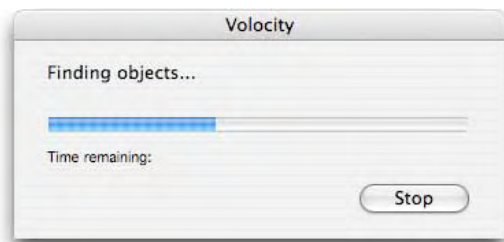

Events and Logs

If you would like to record events to an image sequence during acquisition (e.g. time of the addition of a drug) click on either the Event flag or press the F7 shortcut key.



Enter the appropriate text to identify the event and click OK.

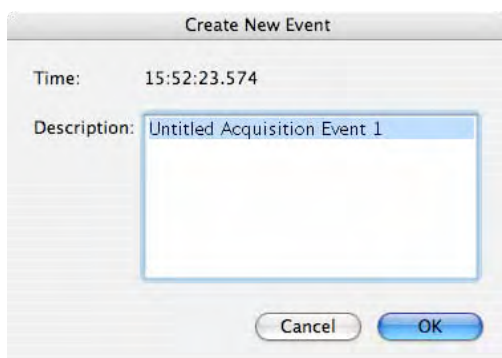

The events are marked on the live plot in numerical order. The text is recorded in the chart view of the measurements item created by the ratio acquisition and in the Experiment Log view.

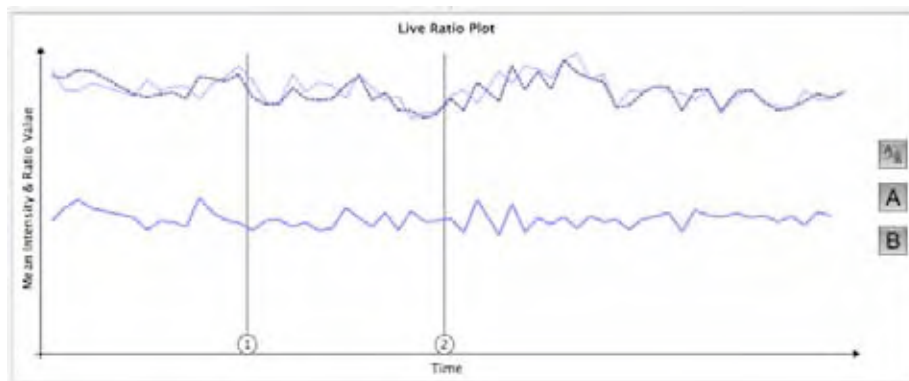

Viewing Results

A ratiometric measurement item is automatically generated at the end of acquisition. This appears in the library directly below the new image sequence. This records values of ROIs for each channel during acquisition so that you do not need to re-analyze your data after acquisition.

When the measurement item is opened, the default view will be the 'Chart View'. The Raw and Analysis views are also accessible from the tabs next to the Chart View tab.

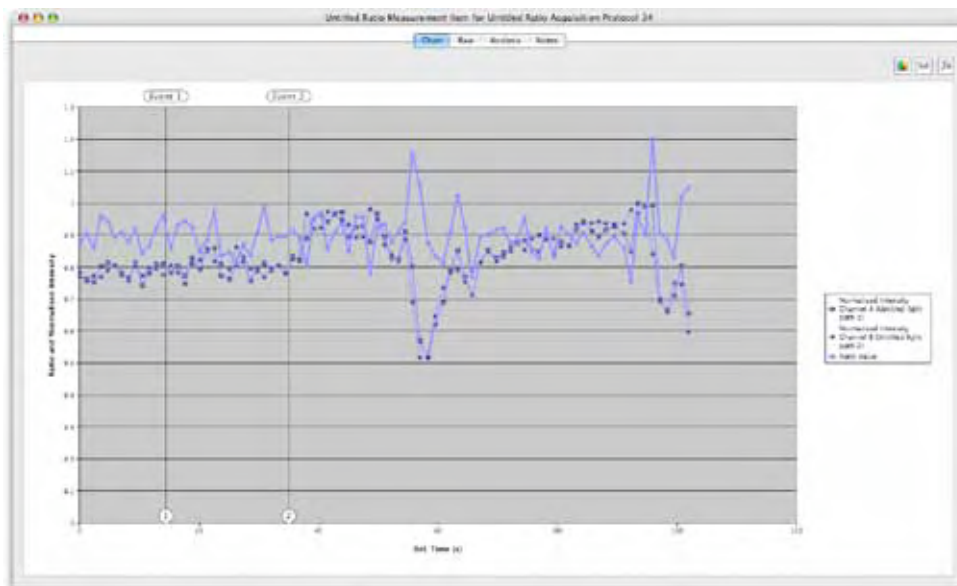

For more information about Measurement Items and making measurements using Velocity Quantitation see the chapter on Velocity Quantitation starting on page 376.

Reanalyzing Ratio Experiments

The analysis carried out as part of the ratio acquisition is not the only choice for final output. Ratio images created during the acquisition may be measured using any of the tools available in Velocity Quantitation. The raw A and B images may even be re-ratioed using the offline ratio tools. See page 489.

Spectral Separation

Overview

Spectral separation is a technology that allows the separation of images containing data from more than one fluorophore into channels that contain data from only a single fluorophore. In order to achieve this separation or “un-mixing”, sample images must be acquired at a minimum of two

different wavelengths. Color cameras lend themselves naturally to this multiple wavelength sampling because they simultaneously sample at three different wavelengths (red, green and blue). However, multiple wavelengths can just as effectively be acquired using monochrome cameras and wavelength changing devices such as filter wheels.

Why Separate Color Images?

Acquiring a single color channel instead of separate blue, green and red channels is an effective means of reducing acquisition time. You may still wish to analyse each of the fluorophores in your experiment in a single monochrome channel. Spectral separation will allow you to acquire the data for up to three fluorophores into a single color channel and separate each fluorophore into its own monochrome channel post-acquisition.

Why Separate Monochrome Images?

Spectral separation can be used to un-mix the contribution of spectrally overlapping fluorophores from a series of grayscale images sampled at different wavelengths (lambda stacks). You can therefore improve the separation of dyes that you have found difficult to separate adequately by more conventional means using filter sets.

Lambda stacks can be composed of a series of images in which the excitation wavelength is constant and the emission wavelength is changed, reflecting the shape of the emission wavelengths of fluorophores. Alternatively, the emission wavelength can be constant and the excitation wavelength changed, reflecting the shape of the excitation wavelengths of fluorophores. It may also be possible to successfully un-mix fluorophores from Lambda stacks in which both excitation and emission wavelengths are varied.

There should be a minimum of two channels in a Lambda stack. The maximum number of fluorophores that can be separated from a lambda stack is equal to the number of images in the lambda stack.

Creating Spectral Signatures from Color Images

In order to accurately separate your fluorophores into individual channels you must first create accurate spectral signatures. A spectral signature allows Volocity to calculate how a sample of only a single fluorophore contributes to the red, green and blue elements of color images.

To generate a spectral signature:

- n First prepare a sample that contains only a single fluorophore.
- n Acquire an image or image sequence of the sample.
- n Open your image or image sequence in the Image View and select a region brightly stained with your fluorophore with a region of interest tool, such as the magic wand tool. You should ensure that no pixels in this region are saturated.



1. Select **Create New** from the Actions menu.

2. Select **Spectral Signature...**

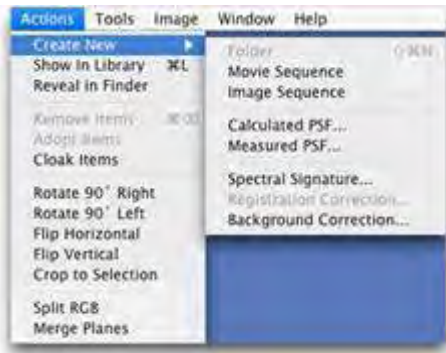

3. The Create Spectral Signature dialog opens.



4. Velocity will assign a sample color and perceived peak wavelength to your new spectral signature. Give the spectral signature a meaningful name and click **OK** to create the signature.

5. Spectral signatures are added to your library.



6. You may inspect a spectral signature by double clicking on its library item.



You should make a spectral signature for each of the fluorophores that you wish to include in your experiments. You can un-mix up to three fluorophores in each experiment.

Creating Spectral Signatures from Monochrome Images

Successful spectral separation is dependent on the creation of accurate spectral signatures. A spectral signature allows Velocity to calculate how a single fluorophore contributes to each point of a lambda stack.

To generate a spectral signature:

- n First prepare a sample that contains only a single fluorophore.
- n Acquire a lambda stack of the specimen into an image sequence.
- n Open your image or image sequence in the Image View and select a region brightly stained with your fluorophore with a region of interest tool, such as the magic wand tool. You should ensure that no pixels in this region are saturated.



1. Select **Create New** from the Actions menu.

2. Select **Spectral Signature...**

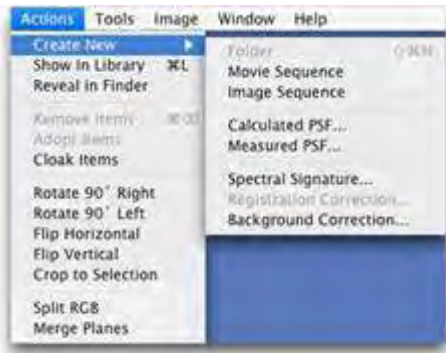

3. The Create Spectral Signature dialog opens.



4. Enter a name for your spectral signature and click **OK**.

5. Spectral signatures are added to your library.



6. You may inspect a spectral signature by double clicking on the library item.

You should make a spectral signature for each of the fluorophores that you wish to include in your experiments.

Separating Color Images

In order to accurately separate each of the channels from your color image, Velocity will need to calculate the contribution made by background. This can be done automatically or you can select a region of interest that contains only background. Velocity can calculate the background directly from this region of interest or you can create a background spectral signature, which you may re-use if your background is consistent between multiple image sequences. To make a background spectral signature:

- n With your region of interest selected, select **Create New** then **Spectral Signature...** from the **Actions** menu.
 - n Give the background spectral signature a name and click **OK**.
1. Select an image or image sequence of a multiply (two or three fluorophores) labeled color specimen.
 2. Select **Separate Spectra...** from the **Tools** menu.



3. In the Separate Spectra dialog select the spectral signatures of the fluorophores in your color image from the drop-down menus. Each of the spectral signatures in your library will be listed in the drop-down menus.



4. Select one of the **Calculate background from** radio buttons.
 - n If you want Volocity to automatically calculate the background, select the **Default background** radio button.
 - n If you have made a background spectral signature, select the **This spectrum** radio button and select your spectral signature from the drop-down menu.
 - n If you have specified a region of interest containing only background, choose the **Current Selection** radio button. If your image sequence is time resolved, the background will be calculated from the first timepoint only unless you select the **Recalculate for each timepoint** checkbox.

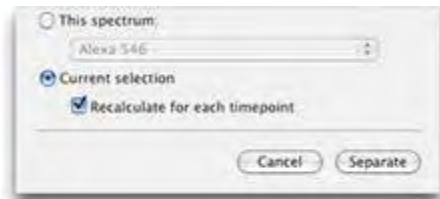

When you select **Recalculate for each timepoint** the background is recalculated for every timepoint from the same region of interest. You must be certain that your region of interest always contains only background (and that no objects of interest stray into your region during the course of the time series).

5. Click **Separate**.

New channels based on your selected spectral signatures will be added to your image sequence. The new channels are monochrome and are colored based on the color of the spectral signature from which they were derived.

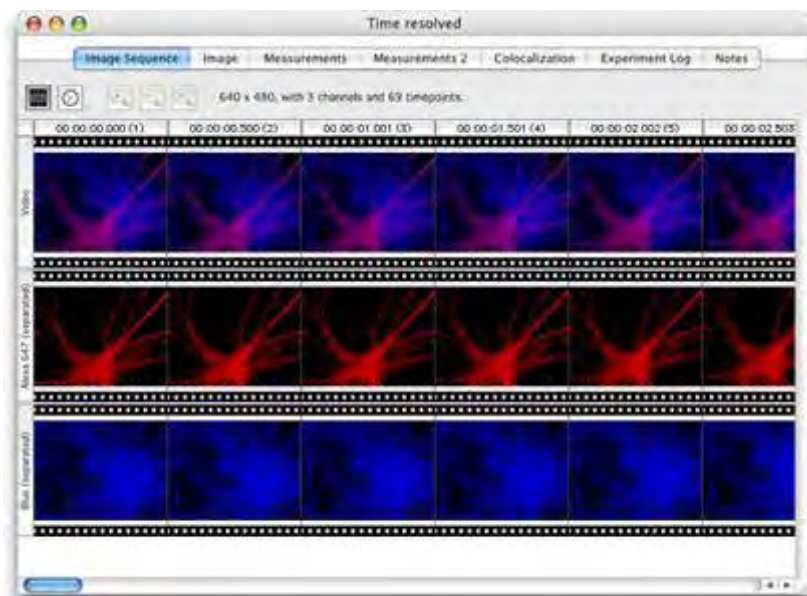

If you un-mix a color image, new monochrome images will be added to a folder of images beneath your original image.

Separating Monochrome Images (Lambda Stacks)

Acquire lambda stacks of specimens labelled with the combination of fluorophores that you wish to separate. You must acquire your experimental specimens at exactly the same wavelengths and relative exposures as your spectral signatures.

In order to accurately separate each fluorophore into its own channel from your lambda stacks, Velocity will need to calculate the contribution made by background. This can be done automatically or you can select a region of interest that contains only background. Velocity can calculate the background directly from this region of interest or you can create a background spectral signature, which you may re-use if your background is consistent between image sequences. To make a background spectral signature:

- n With your region of interest selected, select **Create New** then **Spectral Signature...** from the **Actions** menu.
 - n Give the background spectral signature a name and select **OK**.
1. Open an image sequence in the image view.
 2. Select **Separate Spectra...** from the **Tools** menu.
 3. In the Separate Spectra dialog select the spectral signatures from the drop-down menus of the fluorophores that you wish to un-mix from your lambda stacks.
 - n The number of drop-down menus will be equal to the number of images in your lambda stacks.

- n Each menu contains a list of all the spectral signatures in your library that were derived from lambda stacks containing the same number of images as the image sequence that you wish to un-mix.
- n If you have over-sampled (i.e. the number of images in each lambda stack is greater than the number of fluorophores in your experiment) then you may leave some of the drop-down menus as the default (**No spectrum**).

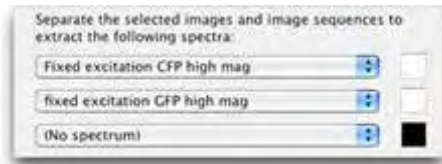

4. Select one of the **Calculate background from** radio buttons.

- n If you want Volocity to automatically calculate the background, select the **Default background** radio button.
- n If you have made a background spectral signature select the **This spectrum** radio button and select your spectral signature from the drop-down menu.

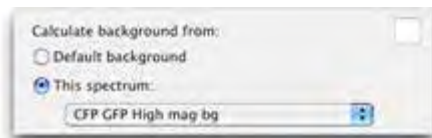

- n If you have a region of interest containing only background selected (in the image view) choose the **Current Selection** radio button. If your image sequence is time resolved the background will be calculated from the first timepoint only unless you select the **Recalculate for each timepoint** checkbox.

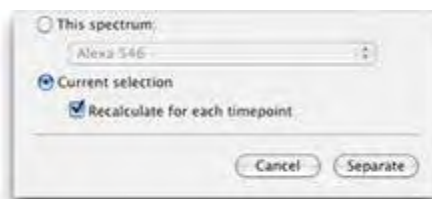

- n When you select the **Recalculate for each timepoint**, the background will be recalculated for every timepoint from the same region of interest. You must be certain that your region of interest always contains only background (and that no objects of interest stray into your region during the course of the time series).

5. Click **Separate**.

New channels, based on your selected spectral signatures, will be added to your image sequence. The new channels will contain only information from a single fluorophore.

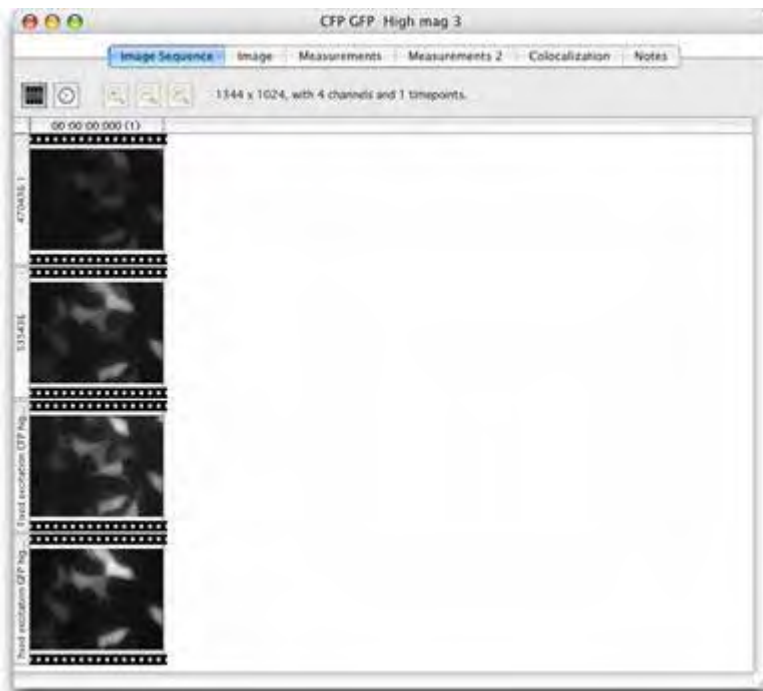

Live Fast Restoration

Volocity Acquisition supports Fast Restoration deconvolution. This option is available in the Video Preview window if you have purchased the Volocity Restoration extension product.

Fast Restoration should only be used with single plane acquisition protocols. If you have multiple planes, you should capture them first and deconvolve them later using Volocity Restoration.

Important: You must create or import a PSF for each channel that will be captured before you can set up the acquisition.

1. Make sure that **Fast Restoration** is selected in the **Devices** Preferences window.

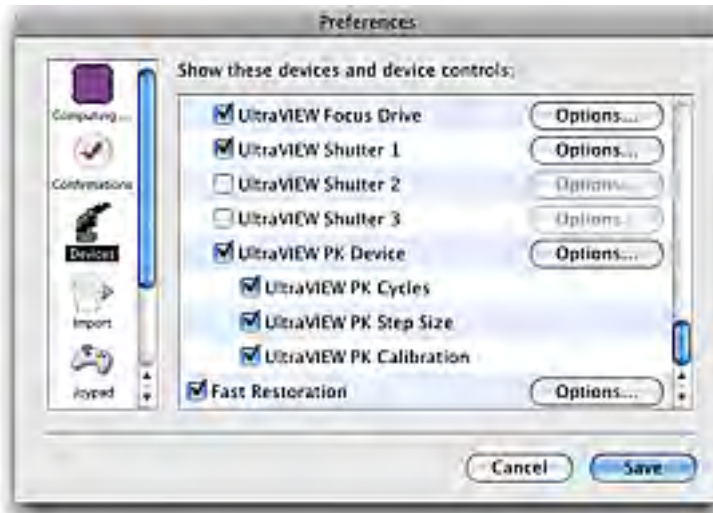

2. You can configure the settings from the **Options...** button or by double clicking on the Fast Restoration icon on the Video Preview window.
3. Ensure that you have the correct PSFs for the channels that you wish to acquire in your Volocity library.
4. Double click on the **Fast Restoration** icon.



The Fast Restoration dialog opens.



5. Select a PSF for each channel that will be captured from the drop-down menus.
6. Decide on the number of neighboring slices that will be included in the restoration algorithm and enter the value in **Capture this many slices above and below** field. The more neighboring slices you include, the longer the process will take.
7. Select the appropriate focus drive from the **Change focus using** drop-down menu.
8. Enter an appropriate value for **Use this Z spacing**.
9. Select the appropriate option for **Generate result using**.



Center Image displays only the deconvolved center image.

Extended focus creates a single image by making a brightest-point merge of all the deconvolved Z-slices of a volume.

10. Click **OK**.
11. Check the **Fast Restoration** box on the Video Preview window. The first time you do this after configuring the settings can take some time as Volocity applies the algorithm and generates the deconvolved image.

OptiGrid®

The OptiGrid® is an optical sectioning technology that, when combined with image analysis software, confers confocal capabilities to wide field microscopes.

The OptiGrid® consists of two pieces of additional hardware:

- n The OptiGrid® paddle, which is inserted into the microscope's fieldstop location and is connected to
- n The OptiGrid® controller box

The OptiGrid® is based on a technique called "Structured Light" (Neil et al 97).

This technique modifies the illumination system of a microscope to project a grid pattern onto the specimen. The grid is moved into three different positions, and an image is acquired at each position. An algorithm is then used to produce a single, derivative, confocal image from which the grid pattern has been removed.

The algorithm takes advantage of the fact that in-focus information changes as the grid moves, whilst out-of-focus information remains constant. Therefore, if information does not change between images, it is out of focus and can be removed from the final image.

Please see the appendix on page 522 for more information about the algorithm and related publications.

OptiGrid® Models

With some models of microscope, chromatic aberration problems have made it difficult or impossible to place the grid pattern in common focus for all excitation wavelengths in use. With earlier OptiGrid® models, this restricted the range of excitation wavelengths that could be used together to acquire image sequences, and created a need for manual refocusing of the OptiGrid®.

The second-generation OptiGrid®, sometimes referred to as the 'Focusing OptiGrid®', incorporates a motor that enables it to be moved axially into different focal positions in the light path of the microscope. Once the correct focal position for an excitation wavelength is established it can be consistently and automatically restored. This extends the range of excitation wavelengths that can be sequentially acquired into a single image sequence.

All OptiGrid® models are supported in versions 4.1 or higher for Mac OS X and Windows.

You need a free USB port in order to run an OptiGrid®.

Note: Manual focus models of the OptiGrid® are connected via the Improvision Acquisition Hub.

Connecting the OptiGrid®

Motorized Focus Model

This section describes how to connect the OptiGrid® model that includes motorized focus control.

Connecting the OptiGrid®

The following components are supplied with your OptiGrid® and are required for installation:

- n OptiGrid® paddle
- n OptiGrid® controller box
- n USB cable
- n Focus motor cable
- n High voltage cable



1. The OptiGrid® controller box has a high-voltage output. The OptiGrid® controller box must be switched off before you connect the OptiGrid® paddle using the power switch which is on the front of the controller box.
2. Connect one end of the high voltage cable to the OptiGrid® paddle and the other end to the Hi Voltage Output connector on the rear of the OptiGrid® controller box.
3. Connect one end of the focus motor cable to the OptiGrid® paddle and the other end to the MOTOR connector on the rear of the OptiGrid® controller box.
4. Connect one end of the USB cable to the USB connector on the rear of the OptiGrid® controller box and the other end to a spare USB port on your computer.

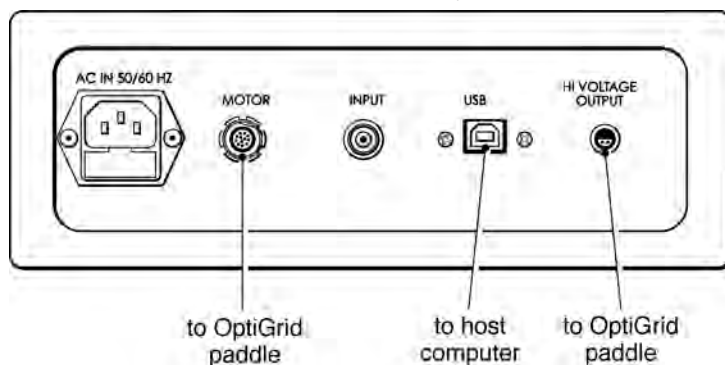

5. If you have a field stop (field diaphragm) installed in you microscope, remove it from the field stop port.



Connecting the OptiGrid®

6. Install your OptiGrid® in the field stop port. Your OptiGrid® “In” position can be found by pushing the OptiGrid® into the field stop port until the “clickstop” engages. In this position the OptiGrid® should be visible in the ocular lenses or with the camera when fluorescence images are observed. The “Out” position can be found by withdrawing the OptiGrid® from the field stop port (disengaging the “clickstop”) until the grid is no longer in the light path, and no elements of the grid housing are in the light path. In this position the OptiGrid® can be left in the field stop port.



7. Switch on the OptiGrid® controller box and start Volocity. The message “Connected to Volocity” will be displayed on the OptiGrid® controller LCD display.
8. You must now set up the OptiGrid® for use with Volocity. This requires you to set up the Device Preferences in Volocity and calibrate the OptiGrid®. See page 261.

Manual Focus Model

The manual focus model of the OptiGrid[®] is connected via the Improvion Acquisition Hub to the computer system that is running Volocity.

The following components are required for installation:

- n OptiGrid[®] paddle
- n OptiGrid[®] controller box
- n Improvion Acquisition Hub
- n Blue BNC-RF cable



1. The OptiGrid[®] controller box has a high-voltage output. The Acquisition Hub and the OptiGrid[®] controller box must both be switched off before you connect the OptiGrid[®] paddle using the power switch is on the front of the Acquisition Hub and the OptiGrid[®] controller box.
2. Connect the OptiGrid[®] paddle to the **OUT HI VOLT** connector on the rear of the OptiGrid[®] controller box.
3. Connect the BNC-RF cable to the **INPUT** connector on the rear of the OptiGrid[®] controller box and connect the other end of the BNC-RF cable to the **OPTIGRID[®]** port on the rear of the Acquisition Hub.

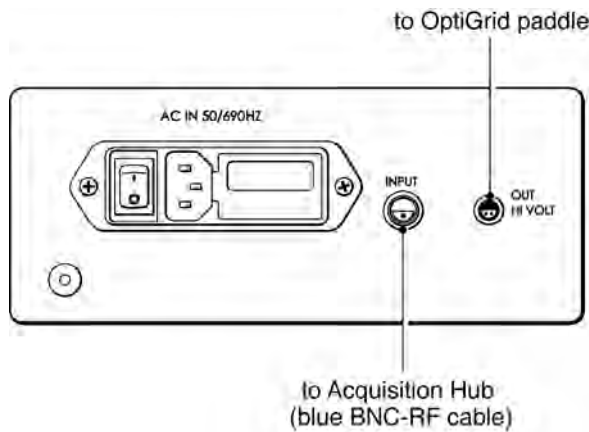

Note: this cable will fit if connected the wrong way around, but the OptiGrid[®] will only work if the cable is connected in the orientation shown below.



4. If you have a field stop (field diaphragm) installed in you microscope, remove it from the field stop port.



5. Install your OptiGrid® in the field stop port. Your OptiGrid® "In" position can be found by pushing the OptiGrid® into the field stop port until the "clickstop" engages. In this position the OptiGrid® should be visible in the ocular lenses or with the camera when fluorescence images are observed. The "Out" position can be found by withdrawing the OptiGrid® from the field stop port (disengaging the "clickstop") until the grid is no longer in the light path, and no elements of the grid housing are in the light path. In this position the OptiGrid® can be left in the field stop port.



7. Switch on the Acquisition Hub and the OptiGrid® controller box. The USB, PWR and RDY lights on the Acquisition Hub and the red light on the front of the OptiGrid® controller should all be illuminated.
NOTE: If the LEDs on the Acquisition Hub or OptiGrid® controller fail to illuminate, check the cabling and make sure that none of the connecting pins are bent. For further information, see page 265.
8. You must now set up the OptiGrid® for use with Volocity. This requires you to set up the device preferences in Volocity and calibrate the OptiGrid®. See page 11.

Setting Velocity Preferences

1. Open the Velocity application.
2. Select **Preferences...** from the Edit menu (Windows) or the Velocity menu (Macintosh).
3. Click on the **Devices** icon in the left-hand panel. A list of devices that have been correctly connected to your computer will appear in the right-hand panel. Each device has a subset of device controls that are listed beneath the device.

Motorized Focus OptiGrid[®] Models

Scroll through the list of devices until you find the **Qioptiq OptiGrid[®] Controller**.

Check the box next to the **Qioptiq OptiGrid[®] Controller**, check the boxes for all of its associated devices.

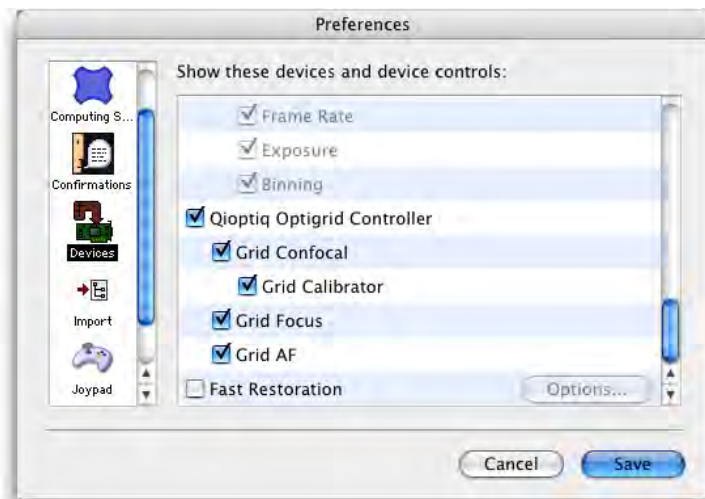

Manual Focus OptiGrid® Models

Scroll through the list of devices until you find the Improvisation Acquisition Hub.

Check the box next to the **Improvisation Acquisition Hub**, check the box next to the **Grid Calibrator**.

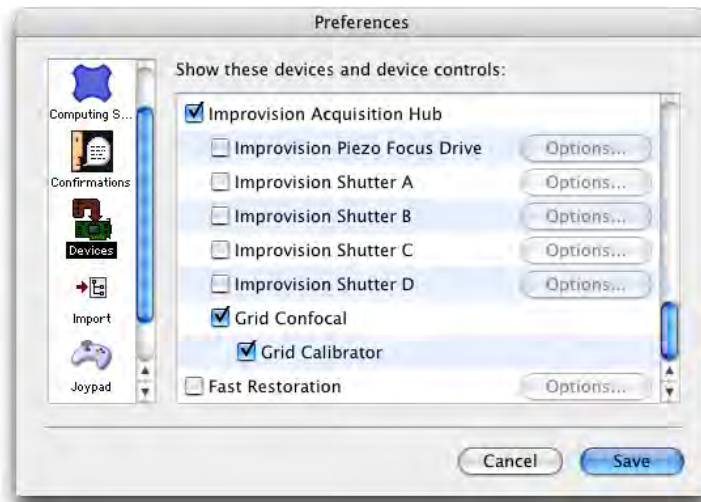

Calibrating the OptiGrid®

It is important to focus the grid manually the first time that you calibrate. The information in this section applies to all OptiGrid® models.

In order to calibrate the OptiGrid® you must have a uniformly fluorescent sample against which the grid can be imaged. Sealing a small amount of fluorescent ink between a slide and a cover slip can make an ideal calibration slide. Highlighter pens are an excellent source of such ink. Alternatively, you can use the Qioptiq calibration slide.

Calibration process

1. Open Volocity and select **Show Video Preview** from the **Window** menu.
2. Mount the calibration slide on the microscope and select an appropriate fluorescence filter. For example, blue excitation and green emission works well with yellow ink.
3. Expose the calibration slide to the fluorescent light source. Calibration can be done with any lens but you will get better grid contrast with low power lenses.
4. Use the microscope focus drive to focus on the fluorescent material. Air bubbles or the edge of the “inked” area make good reference points.
5. Move to a field of view that is uniformly filled with fluorescent material.
6. Move the OptiGrid® to the “in” position in the microscope’s fieldstop location.

7. Adjust the aperture diaphragm on the microscope to improve the contrast if necessary.
8. Direct all light to your camera and, if your camera supports it, select **Auto-Exposure** from the Video Preview controls (or the AE button).

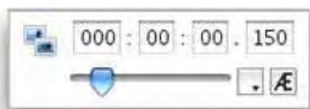

Note: If the exposure is low (<20ms), you may see grid lines in your grid confocal images due to lamp flicker. Avoid low exposures by reducing lamp intensity or using neutral density filters.

9. Use the grid focus control to adjust the position of the OptiGrid[®] until the image of the grid is maximally focused against the fluorescent material on the Video Preview.

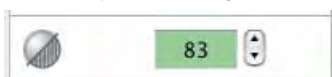

NOTE: With manual focus model of the OptiGrid[®] you must use the “hex wrench” focusing tool to focus the grid. Insert the hex wrench in the middle of the three holes visible on the side of the OptiGrid[®] until it engages. Twisting the hex wrench tool changes the focal position of the OptiGrid[®]. Avoid using excessive force when focusing the OptiGrid[®] as you can damage the grid focus mechanism when the grid has reached the limit of its movement. If resistance is met you are likely to have reached the focus limit and should twist the hex wrench tool in the opposite direction.



10. It is important that the focus is consistent across the grid, see page 278.

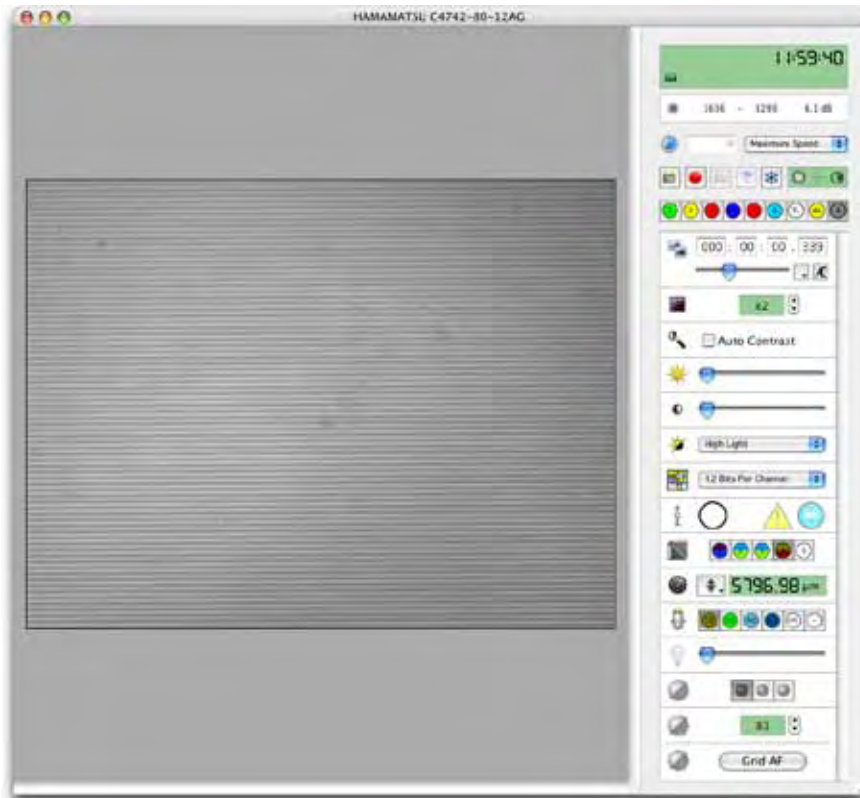

11. Select **Calibrate Confocal Grid...** from the Video menu. A progress bar is displayed as the OptiGrid® is calibrated; this may take several minutes.



12. The calibration of the grid is now complete and the calibration slide can be removed and replaced with the specimen that you wish to image.

OptiGrid® Installation and Calibration Troubleshooting

During calibration, you require an image where the focus is consistent across the grid. Here are examples of good and poor grid images. Note the high grid contrast in the good image:

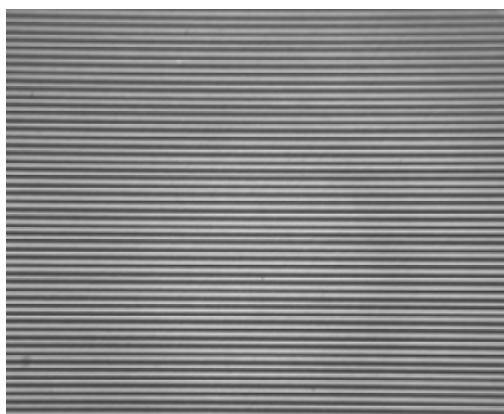

Good grid image

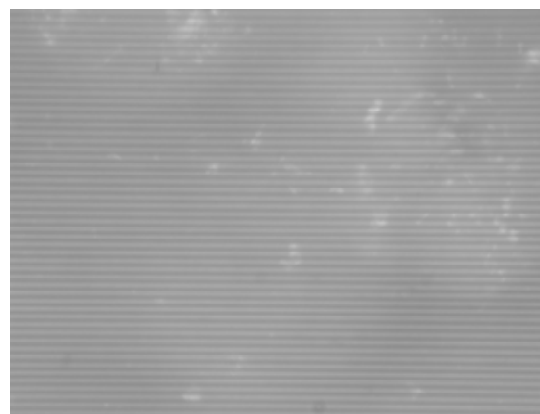

Poor grid image

If you are unable to focus your grid against your calibration slide, despite moving the grid through its full focus range, check the manufacturer of your fluorescence filter set. Filters manufactured by Semrock do not work with the OptiGrid® and should be avoided.

Insufficient contrast warning or error 13901 during calibration (all models)

These errors indicate that the grid is not consistently in focus or that the grid contrast is not high enough for imaging. To rectify this, follow these steps:

1. Ensure that the grid paddle is in the light path.
2. Turn off "Auto Contrast" if your camera supports this function. "Auto Contrast" can lead you to believe that grid contrast is better than it actually is.
3. Use the microscope focus drive to focus on the calibration slide.
4. Adjust the focus of the OptiGrid®, using the Grid Focus Control (motorized focus OptiGrid®) or the hex wrench tool (manually focusing OptiGrid®).
It is important that the focus is consistent across the grid; use the focus adjustment to position the grid such that contrast is as consistent as possible.
5. Repeat steps 2 and 3 to maximize the grid contrast. It can help to use the numerical readout of the minimum and maximum pixel values in the "Video Preview" window to do this. See page 167.
6. Closing the aperture diaphragm will improve grid contrast.
7. Reducing the excitation light intensity and increasing the camera exposure time may improve contrast.

8. Different objectives may give better contrast. Calibration is best performed with a good-quality Plan-Apochromat air objective.

Grid does not move during calibration (all models)

During calibration the grid should move, first slowly in one direction, then more quickly in different directions. If the grid does not move or the calibration fails with error 13902, follow these steps.

Motorized Focus OptiGrid® Models



1. Switch off the OptiGrid® controller. The OptiGrid® controller must be switched off while connecting and disconnecting cables because it has a high-voltage output.
2. Check that the cables are connected correctly. The OptiGrid® paddle should be connected to the OptiGrid® controller via two cables; one to the Hi Voltage Output connector and the other to the MOTOR connector on the OptiGrid® controller. The host computer should be connected to the OptiGrid® controller via a USB cable to the USB connector.
3. Check both ends of the high-voltage cable and make sure that no pins are bent on the connectors. If a pin is bent, carefully bend it back into position with a small screwdriver.

Manual Focus OptiGrid® Models



1. Switch off the OptiGrid® controller and the Acquisition Hub. The OptiGrid® controller must be switched off while connecting and disconnecting cables as it has a high-voltage output.
2. Check cables are connected correctly. The OptiGrid® paddle (or microscope connection) should be connected to the “hi volt” output of the black OptiGrid® controller. The “input” on the OptiGrid® controller should be connected to the “OptiGrid®” port on the Acquisition Hub with the blue cable. Note that the blue cable is not a standard BNC-BNC cable; it is a BNC-RF cable. A standard BNC-BNC cable may physically fit, but will not work.
3. Check that no pins are bent on the high-voltage output of the OptiGrid® controller. There should be four pins, two in the OptiGrid® controller socket and two in the grey paddle cable. If a pin is bent, carefully bend it back into position with a small screwdriver.

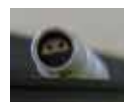
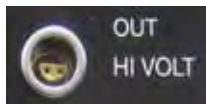

There are four pins, two on each side of the connector

4. Check that no pins are bent on the low-voltage input of the OptiGrid[®] controller. There should be two pins, one in the blue cable and one in the OptiGrid[®] controller socket. If a pin is bent, carefully bend it back into position with a small screwdriver.

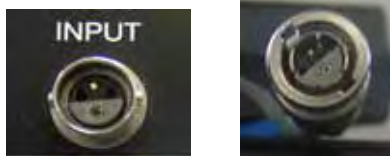

There are pins on both sides of the connector – the ones in this picture are OK.

5. Check that the pin is not bent at the Acquisition Hub end of the blue BNC-RF cable.



6. Check that the “OptiGrid[®]” socket on the Acquisition Hub is not damaged – it is possible for the central part of the socket to get distorted if the pin in the blue cable is not central. If the socket is damaged, it is normally possible to repair it using a pin to tease the metal parts of the socket back into place.



*This OptiGrid[®] socket has been slightly damaged and the metal parts teased back into place.
Compare with the Piezo Z socket on the left.*

7. Switch on both the Acquisition Hub and OptiGrid[®] controller. The USB, PWR and RDY lights on the Acquisition Hub and the red light on the front of the OptiGrid[®] controller should all be illuminated.
8. Retry calibration. If calibration fails again, contact Improvion or the Improvion dealer that supplied your OptiGrid[®].

Using the OptiGrid®

Once you have calibrated the OptiGrid®, you are ready to use it for acquisition. If you intend to acquire multi-channel image sequences you may need to ensure that the grid is correctly focused for each of your excitation wavelengths. The worked examples in this chapter illustrate this process.

Grid controls

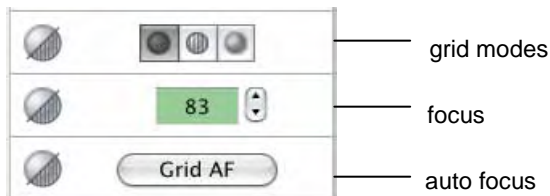

All versions of the OptiGrid® have the grid mode controls. The focus and auto-focus controls are not available with manual focus models of the OptiGrid®.

Auto focus

Click **Grid AF** to allow Volocity to auto focus the grid for you. Volocity will test a number of grid focus positions until it finds the position in which grid confocal images with the best contrast are generated. Auto focus will only work after your grid has been calibrated for the first time and provided you have a specimen mounted and in focus.

Focus

Use this control to adjust the focus position of the grid. You can use this control as an alternative to **Grid AF**, or to fine tune the result of **Grid AF**.

Grid modes

There are three grid mode controls. From left to right:



- n **Grid Off:** Switches the grid off. There is a stationary grid pattern on the Video Preview and from the ocular lenses of the microscope.

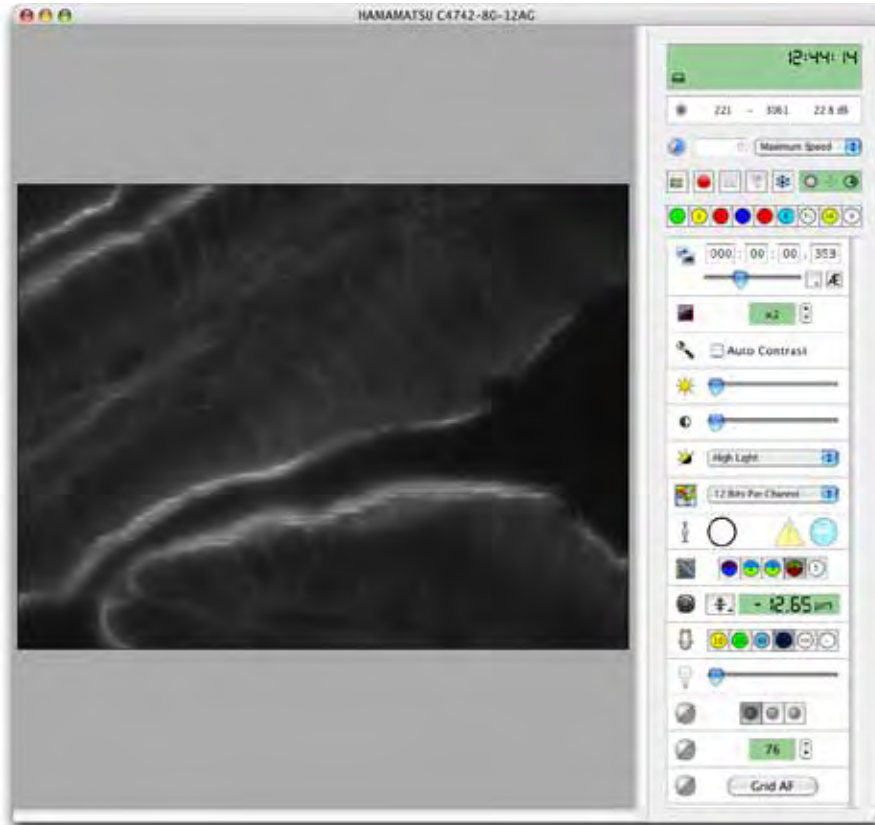

- n **Grid Confocal:** Activates the grid. There is a confocal image on the Video Preview and a moving grid pattern from the ocular lenses of the microscope.

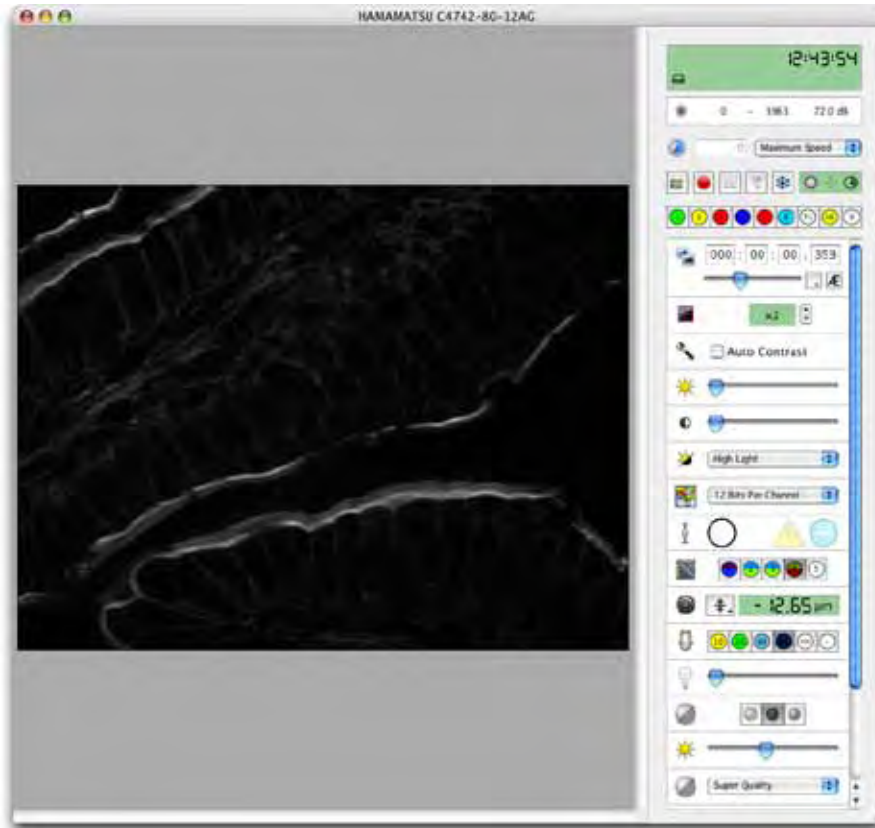

- n **Grid Wide Field:** Activates the grid. There is a wide field image (without grid lines) on the Video Preview and a moving grid pattern from the ocular lenses of the microscope.

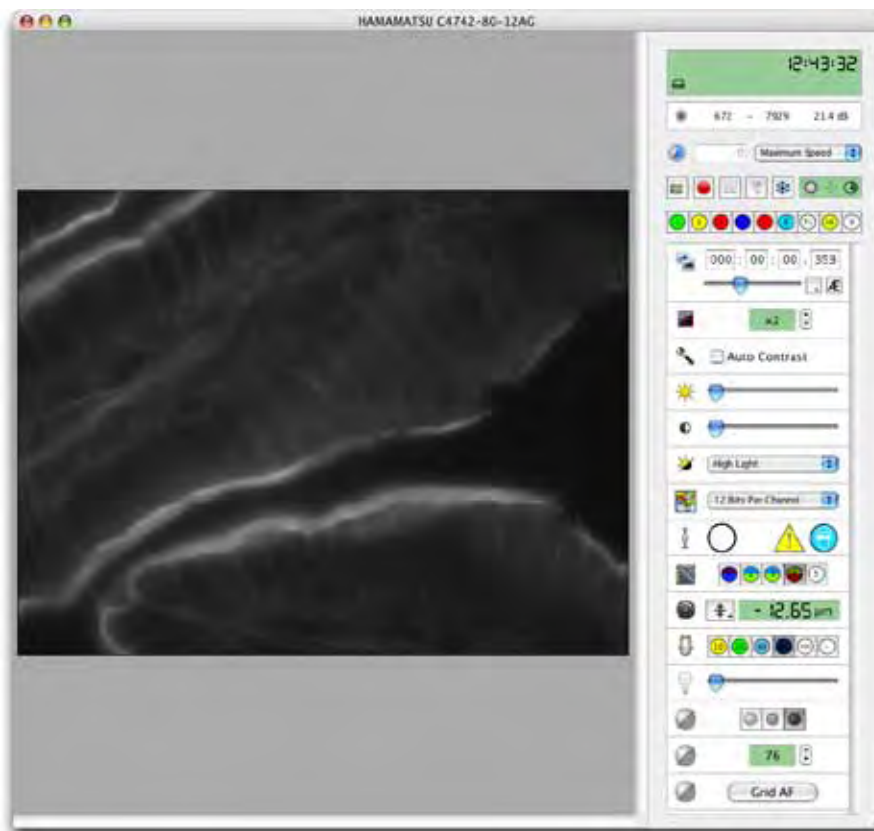

Single-channel grid confocal images

1. Open VLOCITY and select **Show Video Preview** from the Window menu.
2. Mount your specimen slide on the microscope stage and select an appropriate fluorescence filter set.
3. Expose the specimen slide to the light source and select a suitably powered lens.
4. Move to the field of view that interests you.
5. Ensure that the OptiGrid[®] is in the "in" position in the microscope's fieldstop location.

6. Direct all light to your camera and, if your camera supports it, select Auto-Exposure from the Video Preview controls (or the AE button).



7. Set the Grid activation control in the Video Preview to **Off**. You should see clear horizontal lines superimposed on your specimen.

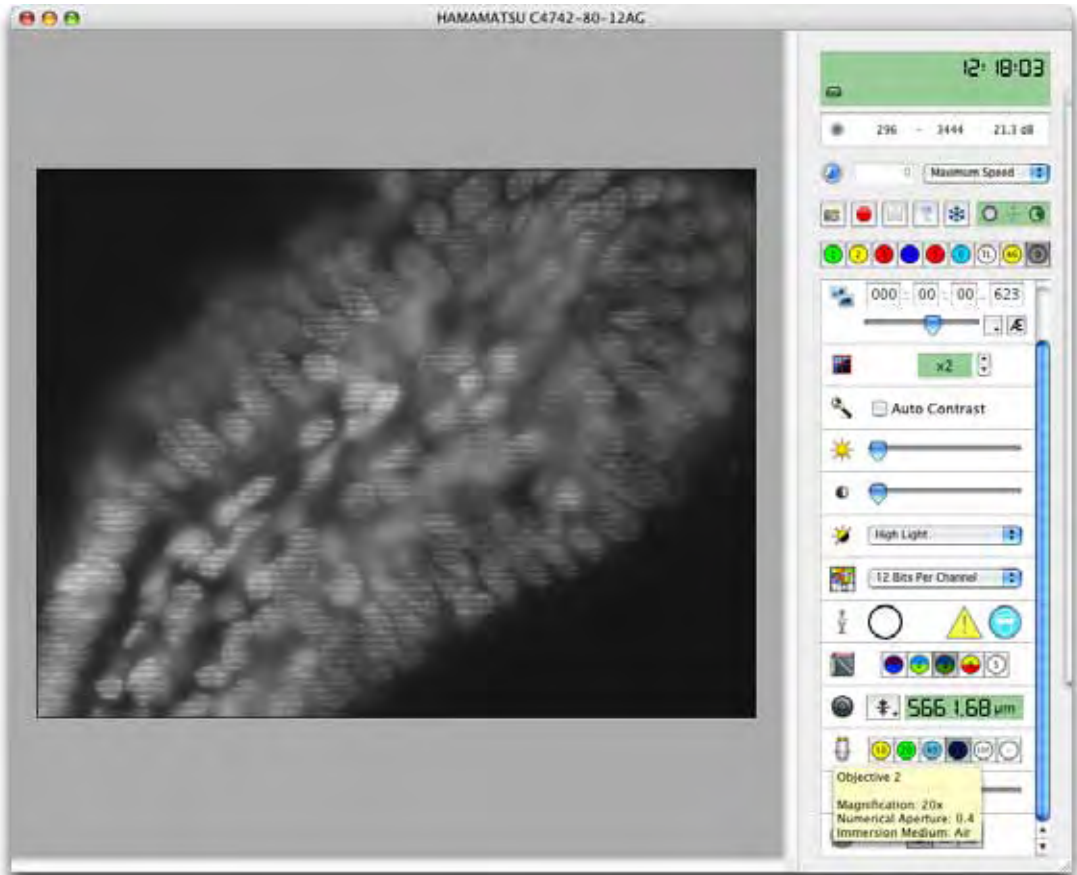

- Click **Grid AF** to focus the OptiGrid[®] automatically. Alternatively, use the grid **Focus** control to focus the OptiGrid[®].

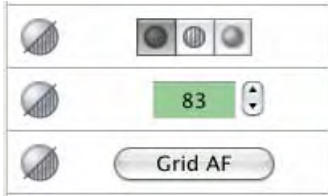

NOTE: With the manual focus model of the OptiGrid[®] you must use the “hex wrench” focusing tool to focus the grid. Insert the hex wrench in the middle of the three holes visible on the side of the OptiGrid[®] until it engages. Twisting the hex wrench tool changes the focal position of the OptiGrid[®]. Avoid using excessive force when focusing the OptiGrid[®] as you can damage the grid focus mechanism when the grid has reached the limit of its movement. If resistance is met, you are likely to have reached the focus limit and should twist the hex wrench tool in the opposite direction.



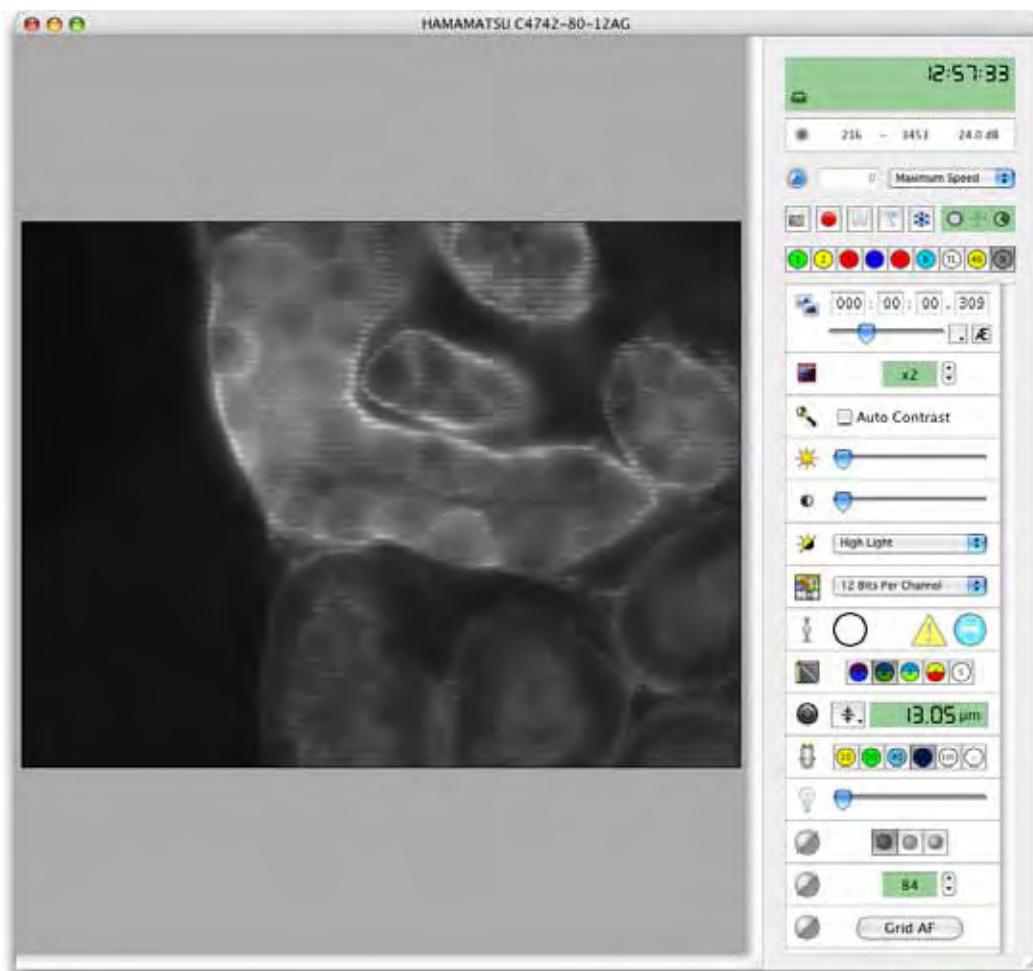

Note: You can also adjust the grid position whilst the grid is in “Grid Confocal” mode. As you move the grid, the signal-to-noise ratio of the grid confocal image will improve if the grid’s focus is improved.

9. Set the Grid activation control to “Grid Confocal”.
10. Change the slide or mount the slide in the first place.
11. You are now ready to acquire grid confocal images or image sequences.

After acquisition, remember to move the OptiGrid® out of the microscope’s light path or ensure that the shutter is closed. If a light source is left on with the grid inserted but not moving, a grid image can be burnt into fixed samples which will cause gridlines.

Multi-channel grid confocal images (Motorized Focus OptiGrid[®])

If you wish to acquire multi-channel grid confocal images, you must ensure that the grid is correctly focused for all of your light paths before acquisition. See page 164 for more information about light paths.

1. Open Volocity and select **Show Video Preview** from the Window menu.
2. Mount the specimen slide on the microscope and select an appropriate light path.
3. Expose the specimen slide to the light source and select a suitably powered lens.
4. Move to the field of view that interests you.
5. Ensure that the OptiGrid[®] is in the “in” position in the microscope’s fieldstop location.
6. Direct all light to your camera and, if your camera supports it, select **Auto-Exposure** from the Video Preview controls (or the AE button).



7. Set the Grid mode control in the Video Preview to Off. You should see clear horizontal lines superimposed on your specimen.
8. Click **Grid AF** to focus the OptiGrid[®] automatically or use the grid focus control to focus the OptiGrid[®].

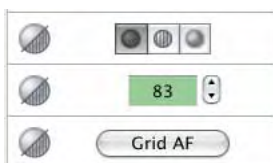

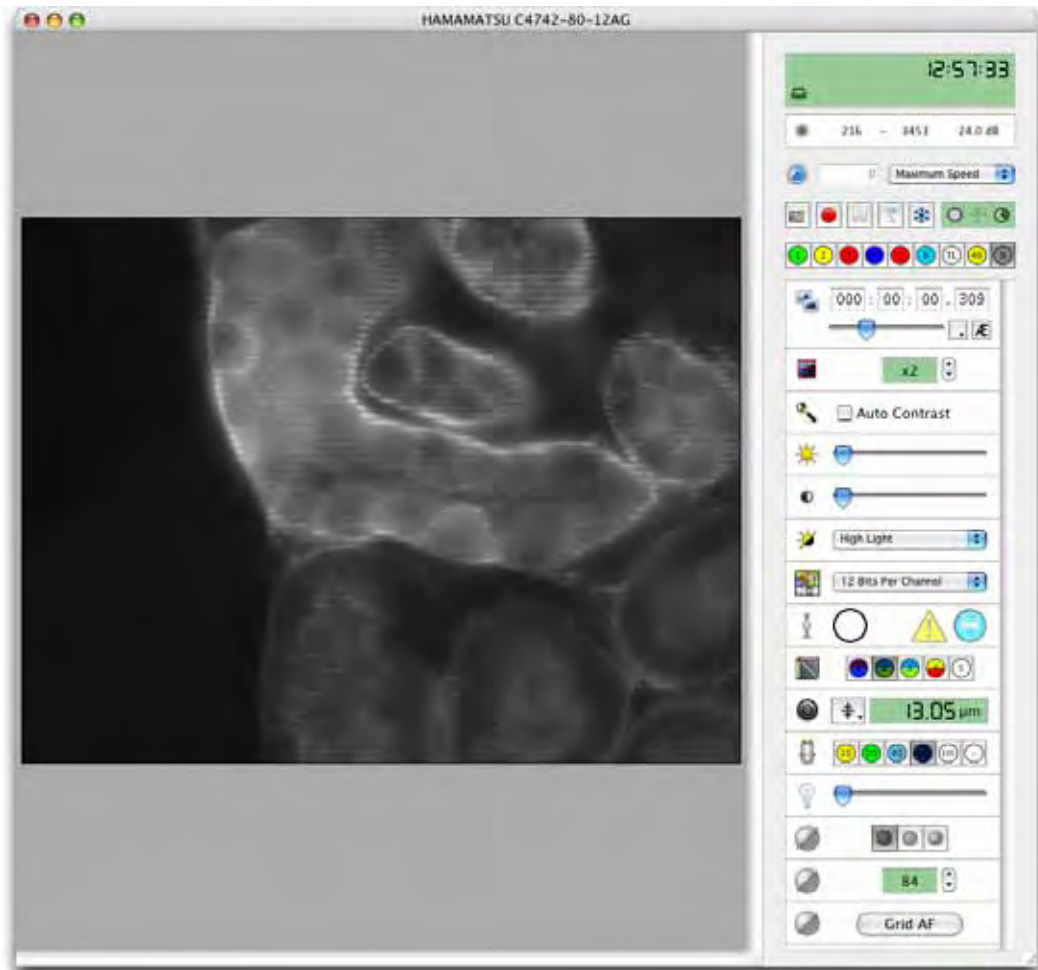

Note: You can also adjust the grid position whilst the grid is in “Grid Confocal” mode. As you move the grid, the signal-to-noise ratio of the grid confocal image will improve if the grid’s focus is improved.

9. Double click on the current light path’s button. The Light Path Properties dialog opens. Scroll through the list of devices until you find **Grid Focus**.

Click on the **Grid Focus** check box to associate the current grid focus position with the light path.

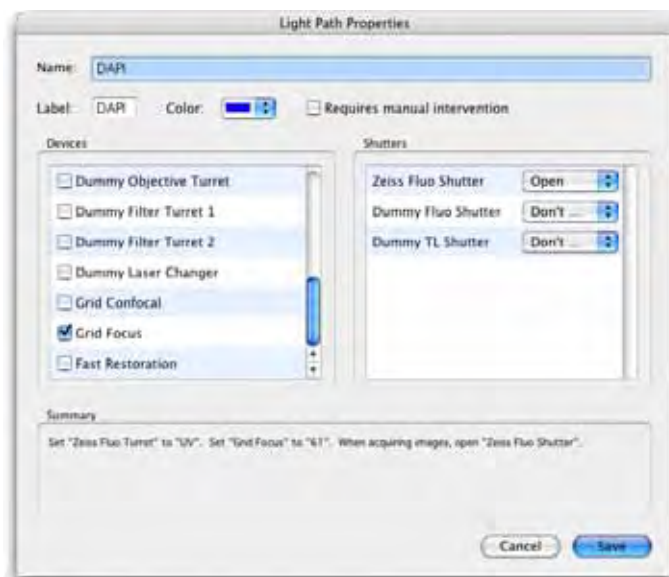

10. Repeat this process for each of the light paths that you wish to restore for your acquisition.
11. Set the Grid activation control to "Grid Confocal".
12. You are now ready to acquire multi-channel grid confocal image sequences.

After acquisition, remember to move the OptiGrid[®] to the "out" position in the microscope's fieldstop location or ensure that the shutter is closed. If a light source is left on with the grid inserted but not moving, a grid image can be burnt into fixed samples which will cause gridlines.

Multi-channel grid confocal images (Manual Focus OptiGrid[®])

With the manual focus OptiGrid[®] it is not possible to associate different grid focus positions with each of your light paths. If your OptiGrid[®] cannot be focused perfectly for each of your light paths, it may be necessary to find a compromise grid focus position in which an adequate image of the grid can be seen for all of your excitation wavelengths.

Adjusting the aperture diaphragm

The position of the aperture diaphragm can have an important effect on the quality of your images; you should always carefully consider its position before and during any imaging sessions. Closing the aperture diaphragm tends to improve the contrast of the grid and, therefore, the contrast of the grid confocal images. Closing the aperture diaphragm also increases the exposure times of your images, so you should balance aperture position with acceptable exposure times.

1. Select the grid confocal mode from the Video Preview controls.



2. Adjust the aperture diaphragm on the microscope.
3. Select Auto-Exposure from the Video Preview controls (you will see the grid lines while Volocity adjusts your exposure).

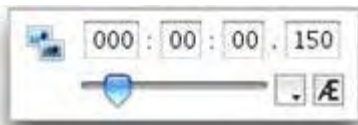

4. Assess whether the quality of the image and the exposure time will meet your experimental needs.

When you are happy with the position of the aperture diaphragm you can proceed with your acquisition of grid confocal images. Acquisition of image sequences can be done as normal, remember to select the grid confocal mode before starting acquisition.

Troubleshooting Grid Imaging

Once you become familiar with the way the grid is working, it becomes clear how artefacts may be generated.

- n Vibration may alter the grid movement and prevent it from moving to the correct position for each of the three raw images.
- n Inconsistent illumination or photobleaching can produce intensity differences between the raw images. The algorithm will extract artefactual data from these illumination differences and grid lines will appear in the final image.
- n A poorly focused (or out of focus) grid will produce little or no difference between the three raw images and a blank confocal image will be generated.

Little or no signal with the grid active

The OptiGrid[®] relies on the grid “marking” in-focus parts of the sample. If the grid contrast in the image is poor, no parts of the sample will be marked and little or no signal will be output.

Recalibrating the grid will not improve the brightness of the grid image – calibration only removes gridlines.

Note: Increasing the camera exposure time will not make the confocal signal brighter – the brightness of the confocal signal is determined purely by the contrast in the grid image.

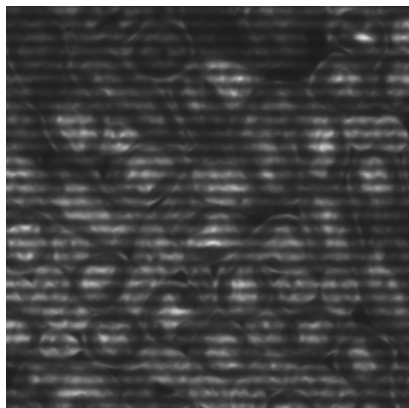

Good grid contrast

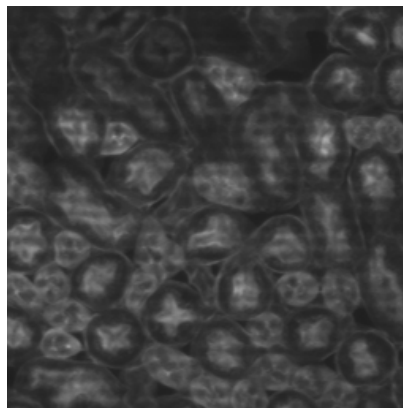

Poor grid contrast

To correct for this:

1. Adjust the grid focus. First focus the sample with the grid off. Select “Grid Confocal” mode, then adjust the grid focus until the confocal signal is as bright as possible.

2. Adjust the imaging system to maximize grid contrast. Closing the aperture diaphragm to reduce stray light will help.
3. It may be necessary to adjust the grid focus for different wavelengths (see page 268) and different objectives.
4. Plan-Apochromat objectives will give better results with multiple wavelengths.

Gridlines in image

Gridlines in the image are caused by the three raw grid images not quite lining up with each other. There are several possible reasons for this:

1. Poor calibration. If gridlines appear, try recalibrating the grid. The grid calibration can change as the grid and microscope heat up in use. Recalibration will correct for this.
2. Vibration can cause grid lines. Isolate the microscope with an anti-vibration table if possible. Equipment containing fans (e.g. camera controllers and light sources) must be isolated from the microscope (e.g. by moving them onto a separate table or onto the floor).
3. Uneven or unstable illumination will cause gridlines. Use a stable light source that offers even illumination. If flicker is a problem, attenuate the light using ND filters and increase exposure times.
4. If the light source is left on with the grid inserted but not moving, a grid image can be burnt into fixed samples which will cause gridlines. Ensure that the fluorescence shutter is closed when possible or that the grid is left running.
5. Fast bleaching samples may show gridlines more than slow bleaching samples. To solve this, reduce the light intensity and increase exposure times.
6. Camera noise will be amplified by the OptiGrid® process and will show as gridlines. Avoid using high camera gain with the OptiGrid®.

Once these factors are eliminated, recalibrate the grid.

Installing and Configuring Photonics Instruments MicroPoint®

Volocity supports the Photonics Instruments MicroPoint® Ablation Laser Unit as a bleaching device.

<http://www.photonic-instruments.com/>

Before you use the MicroPoint® high-intensity laser unit for the first time with Volocity it must be calibrated. You must calibrate the laser again should the laser unit be rotated relative to the microscope, if the camera is moved relative to the microscope, if the dye cell is changed, or if the microscope's objective lens is changed.

Connect the Ablation Laser Unit to the microscope, as instructed in the Photonics Instruments documentation.

Connect the MicroPoint® control box to the computer via a free USB port.

Although the MicroPoint[®] control box connects to Volocity via a USB connection it will function as a “Virtual COM Port” (VCP). In order for this to work you must download and install the driver appropriate for your operating system from <http://ftdichip.com/Drivers/VCP.com>

1. Open Volocity and select Serial Ports from the preferences.
2. Set the usbserial-ELCBXAV5 port to the MicroPoint[®].



10. Select Devices from the preferences.
11. Ensure that all of the MicroPoint[®] devices are selected.



Calibrating Photonics Instruments MicroPoint[®]

Make sure that the laser unit is horizontal (relative to the microscope) before you start, focus and align the laser as described in the Photonics Instruments documentation.

Ensure that your “Laser Safety Filter Block” is always in the light path when using the MicroPoint[®] laser.

1. Mount your mirror slide on the microscope with the reflective surface nearest to the objective lens.
2. Select **Show FRAP Preview** from the Window menu.
3. Switch on your transmitted light lamp.
4. In order to focus on the mirror's surface you should search for a scratch or pit on the surface and focus the microscope on that.
5. Direct all light to the camera and adjust the camera exposure time if necessary.
6. Ensure that any shutters in the laser's light path are open.
7. Select **Calibrate MicroPoint...** from the FRAP menu.
8. The MicroPoint® Calibration wizard is opened.
9. Click **Fire**.

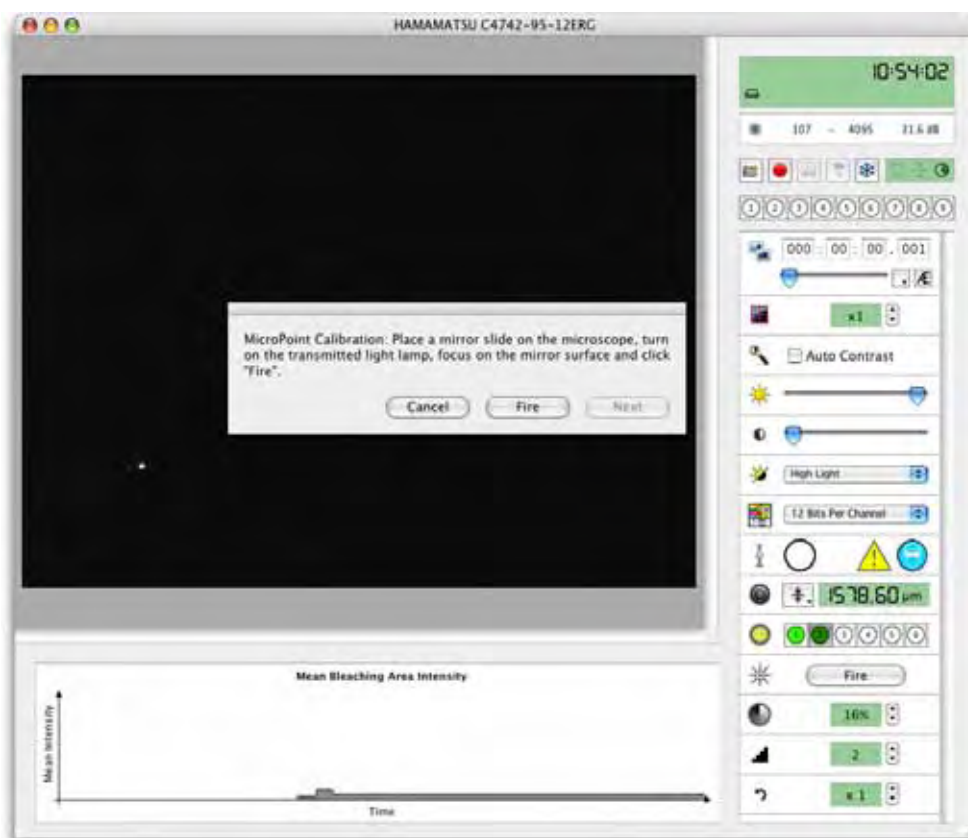

10. The MicroPoint[®] laser is fired. If the laser is correctly focused on the mirror a hole will be cut in the mirror's reflective surface allowing transmission of light and creating a spot. If you are unhappy with the shape and size of the spot, adjust the focus or the intensity of the laser and click **Fire** again.
11. Once you are happy with the size and shape of the spots, click **Next**. A line of holes is fired onto the mirror. Adjust the rotational position of your camera so that the line is horizontal relative to the FRAP preview.

Tip: You may find it easier to judge whether the line is horizontal, if you move it (using the stage) higher up or lower down the Preview window where you can align it with the top or bottom of the screen.

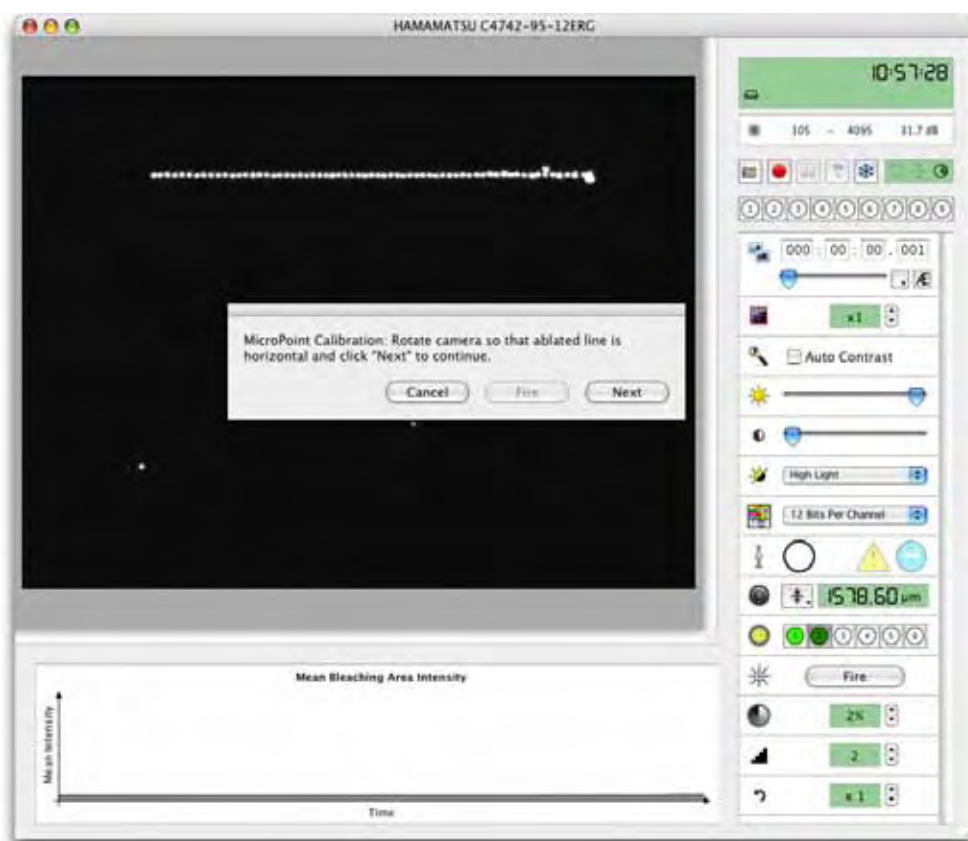

12. Click **Next** to calibrate the laser. A diagonal line of holes is fired across mirror.

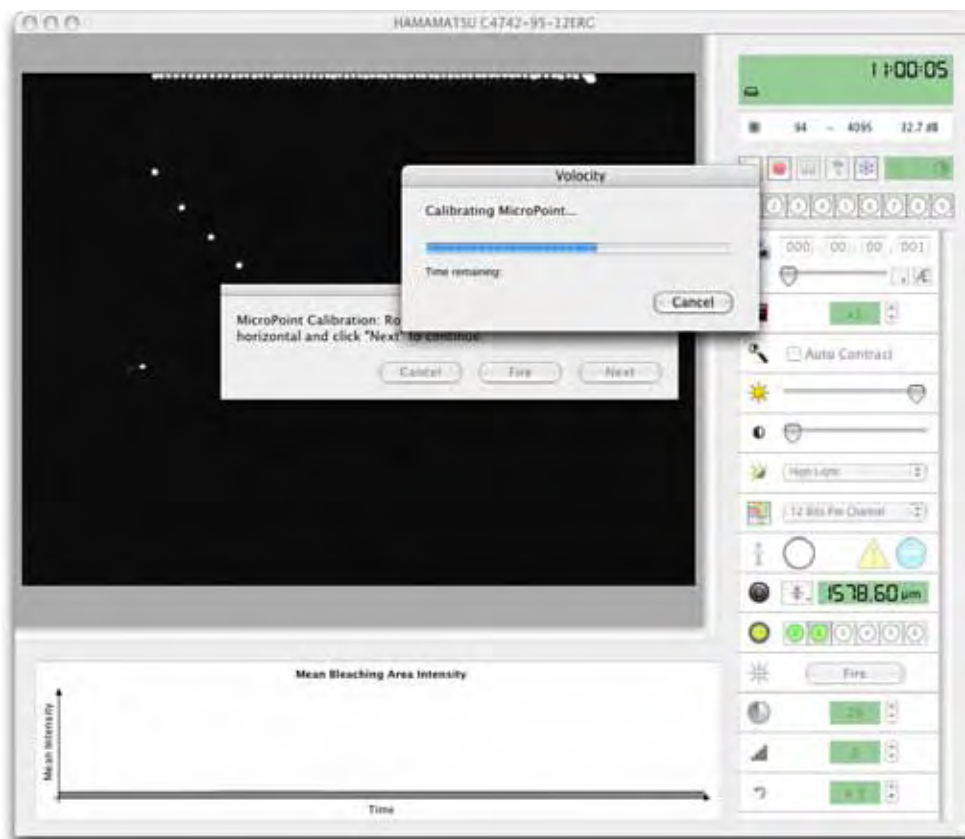

13. Click **Finish**. The calibration wizard will close.

14. You should now check the result: use one of the ROI tools to draw a region of interest on the Preview and click the MicroPoint® **Fire** control within the video controls. The cut area should correspond exactly to the ROI. If this is not the case repeat the calibration procedure.

Volocity Acquisition Worked Examples

Overview

Volocity Acquisition allows you to acquire single or multi-channel, 2D, 3D or 4D image sequences at a single position or at multiple XY points. Before you start acquisition of your image sequences you must configure the Video Preview window and the Acquisition Setup window. Once these steps are complete you can repeatedly execute your acquisition protocol.

This chapter describes how to set up Volocity to carry out single-point and multi-point acquisition and summarizes required settings for different acquisition protocols.

It assumes that you have installed and configured your acquisition device(s) correctly, and set up any additional options, such as Fast Restoration, that you require for your experiment.

For comprehensive installation, configuration and reference information about Volocity Acquisition see the separate chapter starting on page 142. In particular, you may like to review the two sections that describe the Video Preview window, page 167, and how to control devices, page 154.

Example Acquisition Protocols

Acquiring a Single Frame

1. Adjust the camera settings and device controls until you are happy with the image.
2.  Click the capture single frame icon on the Video Preview window. To capture a single timepoint of the acquisition protocol at the current XY location go to the Video menu and select **Capture Timepoint**.

Acquiring a Single Channel over Time

1. Adjust the camera settings until you are happy with the image.
2. In the Acquisition Setup dialog **Channels/Z** tab:

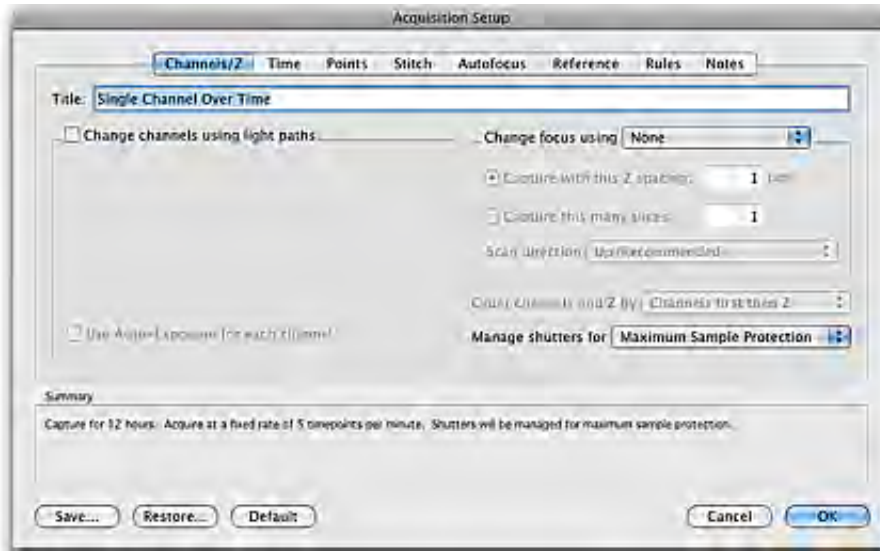

- n Ensure that **Change channels using light paths** is not selected
- n Set **Change focus using** to None
- n Set **Manage Shutters for** to the appropriate option for the priorities of the experiment

3. In the **Time** tab:

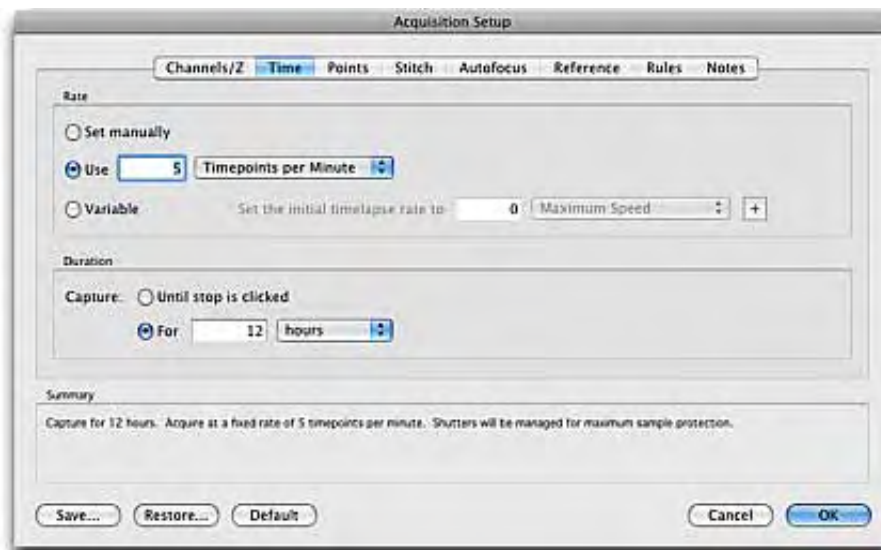

- n Set the **Rate** i.e. how much time is to pass between timepoints
- n Choose the **Duration** for the experiment.
- 3. Click **OK** to close the Acquisition Setup dialog, leaving the experiment ready to run, and return to the Video Preview.
- 4.  Click the capture image sequence icon on the Video Preview window.
- 5. While the protocol is running, capturing images the timelapse interval may be changed using the options in the Video Preview.

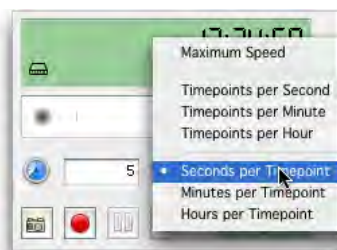

Acquiring Multiple Channels over Time

1. If you wish to use the same exposure for each channel, ensure that the **Auto Contrast** option has been selected in the Video Preview window.



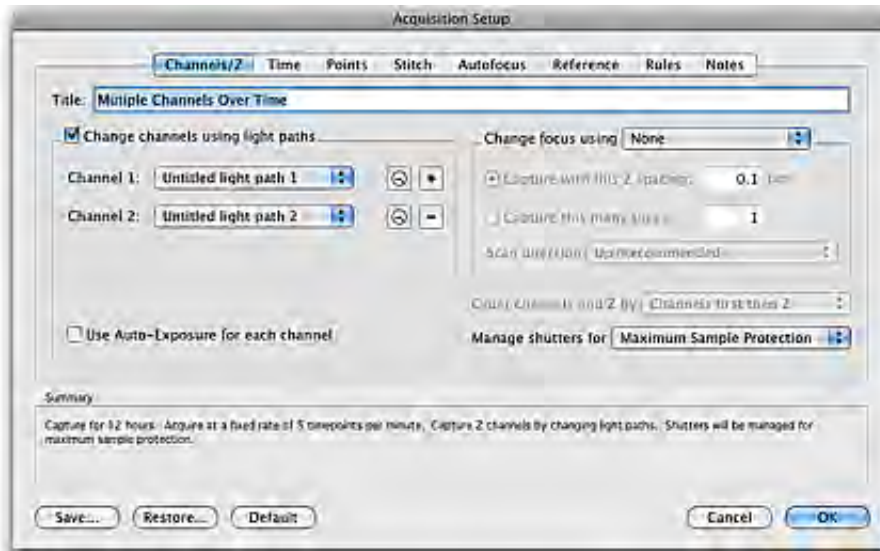

2. If you wish to manually set exposures for each channel ensure that exposure is stored in the light path and that each is stored when the exposure is reading the desired value.
3. In the Acquisition Setup dialog, **Channels/Z** tab:

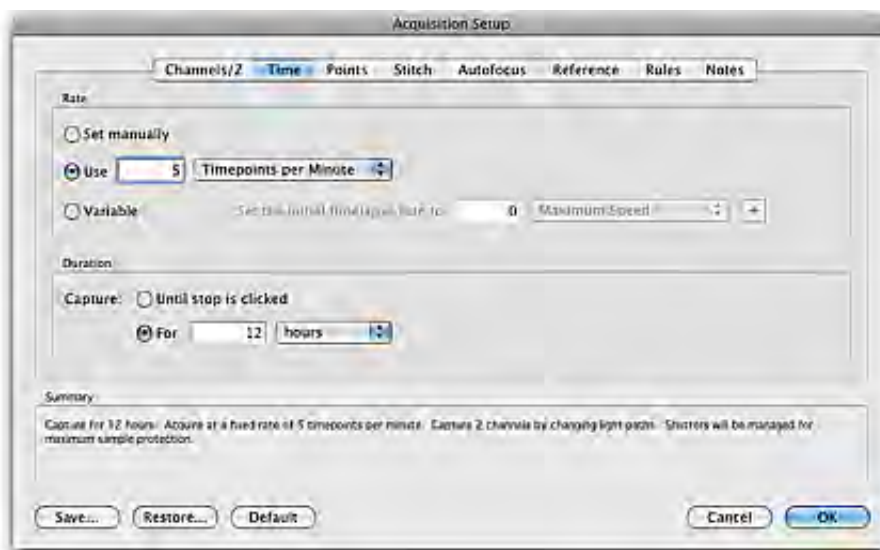

- n Ensure that **Change channels using light paths** is selected. Add the correct number of channels.
- n Set **Change focus using** to None.
- n Choose to **Manage shutters for** Maximum Speed or Maximum Sample Protection depending on the priority of the experiment.

4. In the **Time** tab:



- n Set the **Rate** to reflect the desired interval between timepoints.
 - n Choose how long the experiment is going to be by setting the **Duration**.
4. Click **OK** to close the Acquisition Setup dialog leaving the experiment ready to run.
 5.  Click the capture image sequence icon on the Video Preview window.
 6. While the protocol is running, capturing images, the timelapse interval may be changed using the options in the Video Preview.

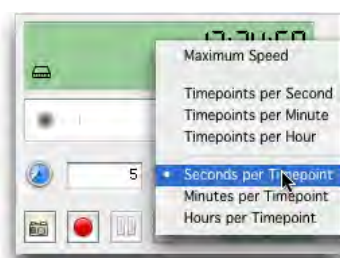

Acquiring a Single Channel at Multiple Z-Planes and Single Timepoint

1. At the midpoint of your specimen adjust the camera settings until you are happy with the image.
2. In the Video Preview store top and bottom of the stack by moving the focus to the limits of the stack and storing Top and Bottom values in the focus drive control.
3. In the Acquisition Setup dialog **Channels/Z** tab:



- n Ensure that **Change channels using light paths** is not selected
- n Select the appropriate device from the **Change focus using** drop-down menu and set an appropriate **Z spacing**
- n Choose to **Manage shutters for** Maximum Speed or Maximum Sample Protection depending on the priority of the experiment.

4. In the Time tab:



n Set the **Duration** = 1 timepoint

4. Click **OK** to close the Acquisition Setup dialog leaving the experiment ready to run.

5.  Click the capture image sequence icon on the Video Preview window.

Acquiring Multiple Channels at Multiple Z-Planes and Single Timepoint

1. At the midpoint of your specimen adjust the camera settings for each channel until you are happy with the image.
2. If you wish to use the same exposure for each channel, ensure that the **Auto Contrast** option has been selected in the Video Preview window. This will ensure the optimum contrast settings to assist setting one exposure for all channels.



3. If you wish to manually set exposures for each channel ensure that exposure is stored in the light path and that each is stored when the exposure is reading the desired value.
4. In the Video Preview store top and bottom of the stack by moving the focus to the limits of the stack and storing Top and Bottom values in the focus drive control.
5. in the Acquisition Setup dialog **Channels/Z** tab:

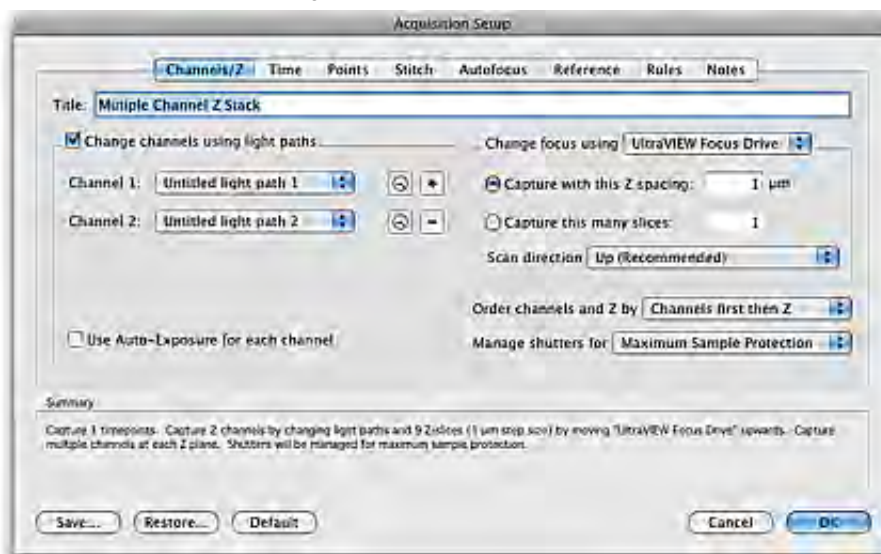

- n Ensure that **Change channels using light paths** is selected. Add the correct number of channels and assign lightpaths to each of them.
- n Select the appropriate device from the **Change focus using** drop-down menu and set an appropriate **Z spacing**
- n Select the appropriate option from the **Use this ordering for channels and Z sections** drop-down menu.

- n Choose to **Manage shutters** for Maximum Speed or Maximum Sample Protection depending on the priority of the experiment.

In the **Time** tab:

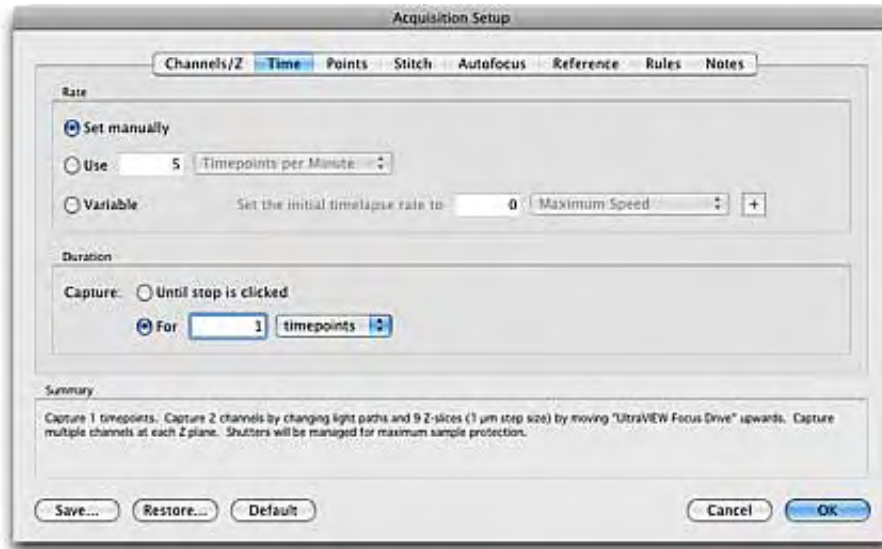

- n Set the **Duration** = 1 timepoint.
5. Click **OK** to close the Acquisition Setup dialog leaving the experiment ready to run.
 7.  Click the capture image sequence icon on the Video Preview window.

Acquiring a Single Channel at Multiple Z-Planes Over Time

1. At the midpoint of your specimen adjust the camera settings until you are happy with the image.
2. In the Video Preview store top and bottom of the stack by moving the focus to the limits of the stack and storing Top and Bottom values in the focus drive control.
3. In the Acquisition Setup dialog **Channels/Z** tab:

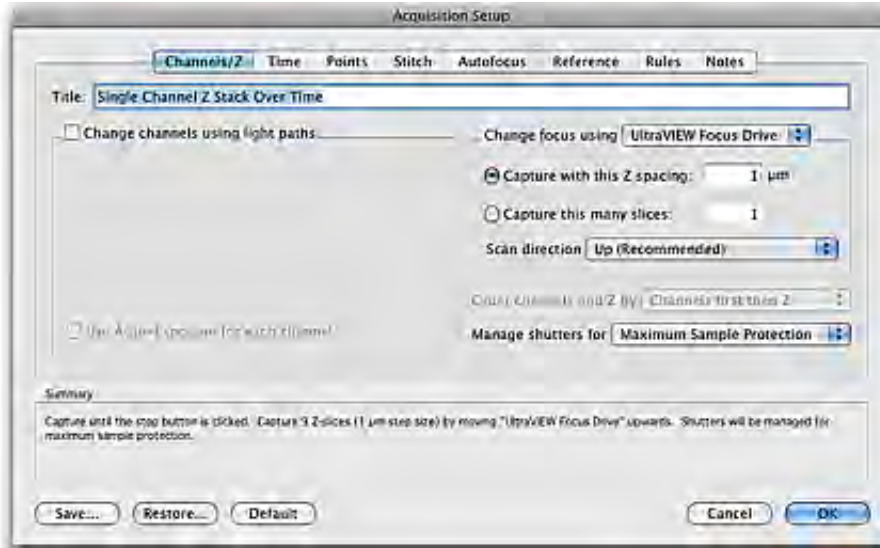

- n ensure that **Change channels using light paths** is not selected
- n select the appropriate device from the **Change focus using** drop-down menu and set an appropriate **Z spacing**
- n Choose to **Manage shutters for** Maximum Speed or Maximum Sample Protection depending on the priority of the experiment.

4. In the **Time** tab:

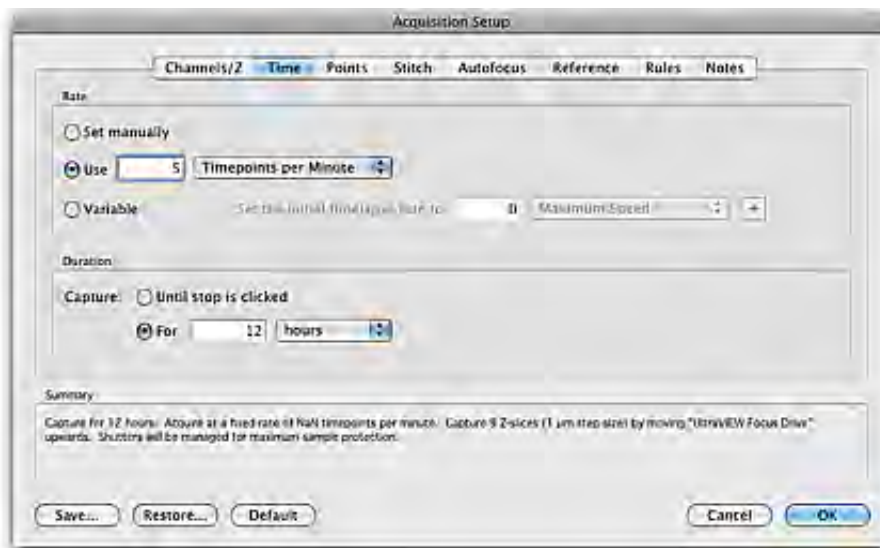

- n set a **Rate** for the experiment
 - n set a **Duration**
5. Click **OK** to close the Acquisition Setup dialog, leaving the experiment protocol ready to run, and return to the Video Preview.
 6.  Click the capture image sequence icon on the Video Preview window.

Acquiring Multiple Channels at Multiple Z-Planes Over Time

1. At the midpoint of your specimen adjust the camera settings for each channel until you are happy with the image.
2. If you wish to use the same exposure for each channel, ensure that the **Auto Contrast** option has been selected in the Video Preview window. This will ensure the optimum contrast settings to assist setting one exposure for all channels.





3. If you wish to manually set exposures for each channel ensure that exposure is stored in the light path and that each is stored when the exposure is reading the desired value.
4. In the Video Preview store top and bottom of the stack by moving the focus to the limits of the stack and storing Top and Bottom values in the focus drive control.
5. On the Acquisition Setup dialog **Channels/Z** tab:

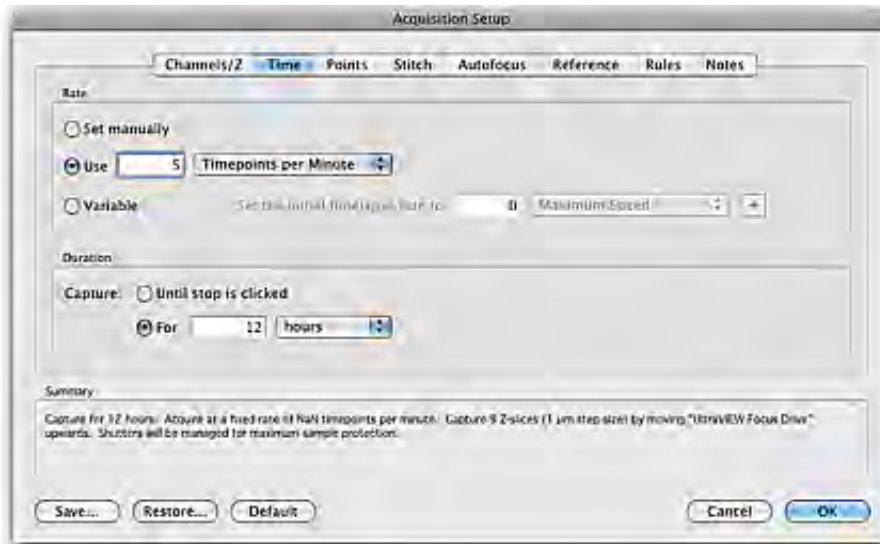

- n Ensure that **Change channels using light paths** is selected. Add the correct number of channels and assign a lightpath to each
- n Select the appropriate device from the **Change focus using** drop-down menu and set an appropriate **Z spacing**.
- n Select the appropriate option from the **Use this ordering for channels and Z sections** drop-down menu
- n Choose to **Manage shutters for** Maximum Speed or Maximum Sample Protection depending on the priority of the experiment.

6. In the **Time** tab:



- n Set the **Rate** for the interval between timepoints
 - n Set the **Duration** of the experiment
7. Click **OK** to close the Acquisition Setup dialog, leaving the experiment protocol ready to run, and return to the Video Preview.
 8.  Click the capture image sequence icon on the Video Preview window.
While the experiment is running it is possible to adjust the timelapse settings using the control in the Video Preview.

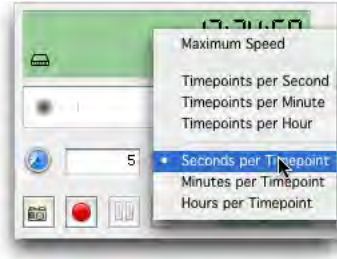

Acquiring at Multiple XY Locations

Any of the previous examples may be performed at multiple XY locations using a motorized stage. It is essential that locations at which acquisition is to take place are first stored on the stage area by marking points or using a well overlay. See page 209 for more information.

1. In addition to the options for channels, focus, timelapse and duration. Select the XY stage to be used in the **Points** tab.
2. If you want Volocity to auto-focus on your points during the acquisition, select the light path that you wish to use for auto-focusing from the drop-down menu.
3. If you have chosen to acquire multiple Z planes during your experiment, you now need to ensure that the top and bottom focus limits are set correctly.

Note: You should avoid re-setting the zero value of your focus drive after setting your acquisition points. If you do so, you will invalidate the Z coordinates stored with each point.

Volocity Visualization

Overview

Volocity Visualization is a separate product in the Volocity family. The functionality described here will only be available if Volocity Visualization is licensed on your system. See page 38 for information about activating additional products on your system. Volocity Visualization permits different ways of displaying the data in the Image view.

3D Opacity is an interactive high resolution renderer with options for how the data is displayed. Resolution of the data is managed to maintain interactivity. 3D Opacity rendering can also show feedback from selections. If Volocity Visualization is used in conjunction with Volocity Quantitation measurements feedback can be shown in the 3D Opacity mode.

3D Ray tracing is a processor intensive rendering that requires more time to calculate the image and is therefore not interactive. Different effects may be generated with the ray tracer but it does not support measurements feedback or scale shown on the view.

3D Slice allows 3D or 4D data to be viewed at a different orientation of slicing and, if required, the data may be re-sliced to create another version of the data at the new orientation.

Specific recommendations are made for the graphics cards. These are detailed in the System Requirements technical note. This technical note will be updated as new graphics cards become available and are tested.

If the installed graphics card does not meet this specification, 3D Opacity Rendering will not be possible. Error messages including the term "OpenGL" are shown.

3D in the Image View

Select the item in the library that you wish to view, or render, in 3D. Double click on the item thumbnail to open it in a separate window.

1. Click on the Image tab if you are not already viewing this tab. Select a 3D rendering option from the Mode pop-up in the tool bar or navigate to the Image menu, and the Mode submenu to select an option. There is more detail on the individual Renderers used to produce the image shown on the screen in the relevant sections.
2. The volume will be shown in 3D in the Image view.

The following example shows a view generated by the 3D Opacity Renderer.

A progress bar will be displayed here as you work with rendered data

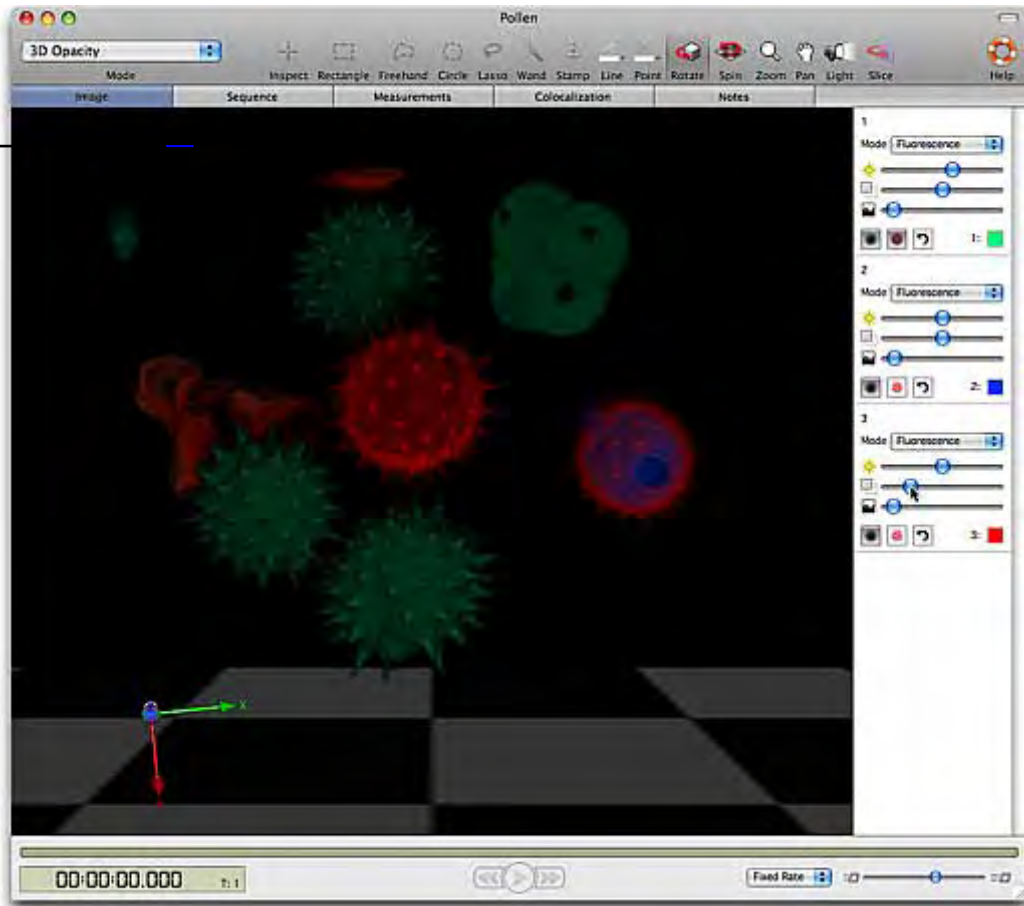

Once you have selected the 3D rendered view you can use the tools in the toolbar to manipulate the object in space (see page 325), the channel controls to adjust how individual channels appear and the time navigation controls to step or play through timepoints (see page 311). Select **Reset View** from the 3D menu to return the object to its default position. Volocity displays a progress bar in the top left-hand corner of the view as it applies any changes that you make.

3D Modes in Image View

When Visualization is licensed on the system additional modes are available in the Image view.

- n 3D Opacity

3D Modes in Image View

- n 3D Ray Tracer

- n 3D Slice

Change the mode from either the tool bar or the image menu.

3D Opacity

The 3D Opacity renderer is extremely versatile, many effects are possible within one mode of the image view.

To view 3D data using the Opacity renderer select 3D Opacity from the mode pop up in the Image view tool bar. Channels may be overlaid or tiled.

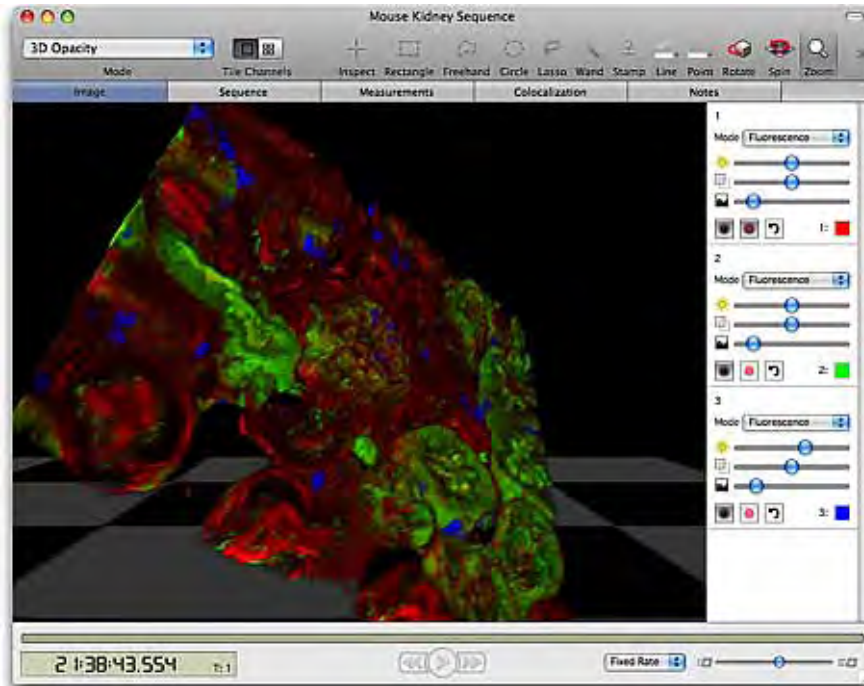

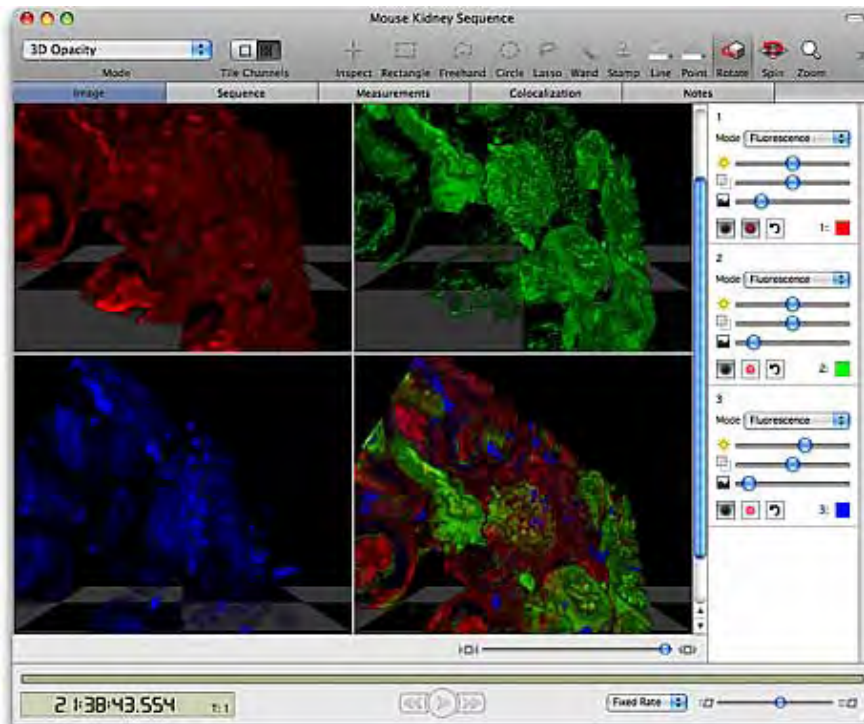

Move the volume using mouse cursor. Different movements are possible by selecting different tools.

Move to different timepoints in the dataset using the time navigation controls.

Change the appearance of the volume using the channel controls.

Channel Controls

If the channel controls are not visible select Image menu, **Show Channel Controls**. There is a panel of controls for each channel in the data set. The first control is the Renderer mode. Within the same view individual channels may be set to any one of these modes. The 3D Opacity renderer offers four choices:

- n **Fluorescence:** applies direct opacity rendering, which is designed for use on data from fluorescence microscopy. Control over brightness, density and black level is given on a per channel basis.
- n **Brightfield:** applies direct opacity rendering, which is designed for use on data generated by transmitted light microscopy. Control over brightness, density and black level is given on a per channel basis.
- n **Max Intensity:** applies direct maximum intensity projection rendering. The brightest intensity in the view path to the screen will form the screen image. Max Intensity rendering will not be

visible against background colors lighter than the data so avoid using light colored backgrounds with this mode. Control over brightness and black level is given on a per channel basis.

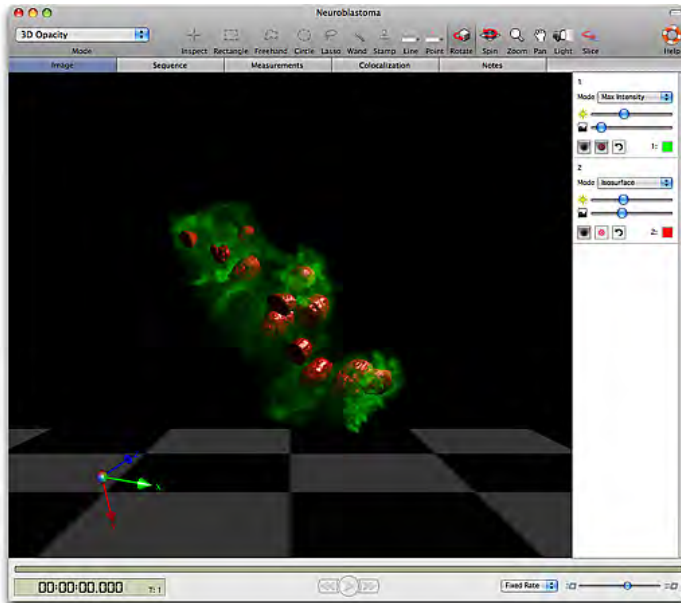

One of two channels in Max Intensity for a transparent effect. Also useful for fine processes and data with low numbers of z slices. The second channel is in Isosurface mode and is therefore completely solid.

- n **Isosurface:** applies indirect surface rendering, which identifies a surface around objects where all voxel intensity values are the same. This intensity is determined by the black level setting. The surface is made up of complex polygons. This generates apparently solid objects which cannot be seen through. No signal from objects behind can pass through an isosurface. Control over brightness and black level is given on a per channel basis. Light position, as controlled by the light tool affects isosurfaces. Isosurfaces cannot be generated for RGB or true color channels. The isosurface option will not be available for channels with millions of colors depth.

3D Opacity

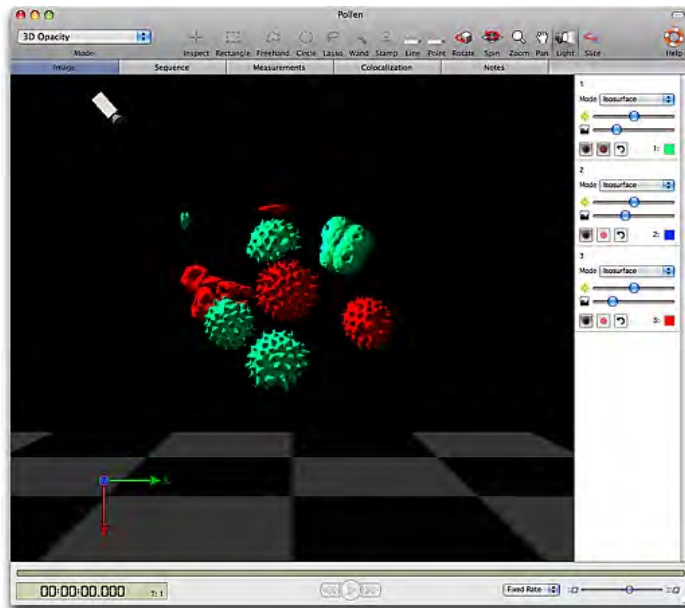

A three channel dataset where all three channels are in the isosurface mode showing the use of the scene light to change the lighting of the isosurfaces. The isosurface option is not available for millions of colors depth channels.

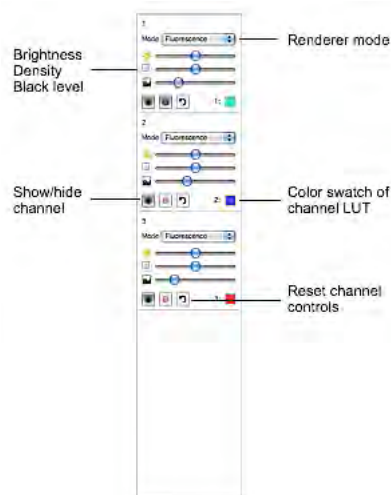

Use the slider controls to control the brightness, density and black level of the rendered image.

- n **Brightness:** alters the brightness of the rendered voxels. A multiplication factor is applied to the intensity values of the voxels. Moving the slider to the left reduces the brightness, moving it to the right increases brightness.
- n **Density:** alters the density of the rendered voxels. This affects how much can be seen through the structure. Denser voxels do not allow signal from the objects behind to pass

through to the screen image. Moving the slider to the right increases voxel density, moving it to the left decreases density.

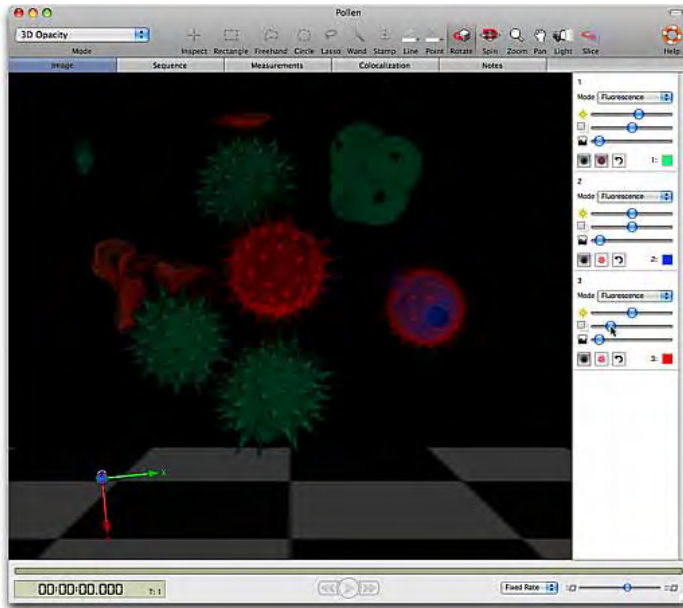

Three channel data with all three channels set to Fluorescence. One channel, red, has been made more transparent by reducing the density control, just for that channel.

- n **Black Level:** sets a value at which voxels of that intensity or lower will not be rendered. The remaining data is rescaled across the full display range of the screen. Increasing the black level removes low intensity voxels from the image as illustrated below.

3D Opacity

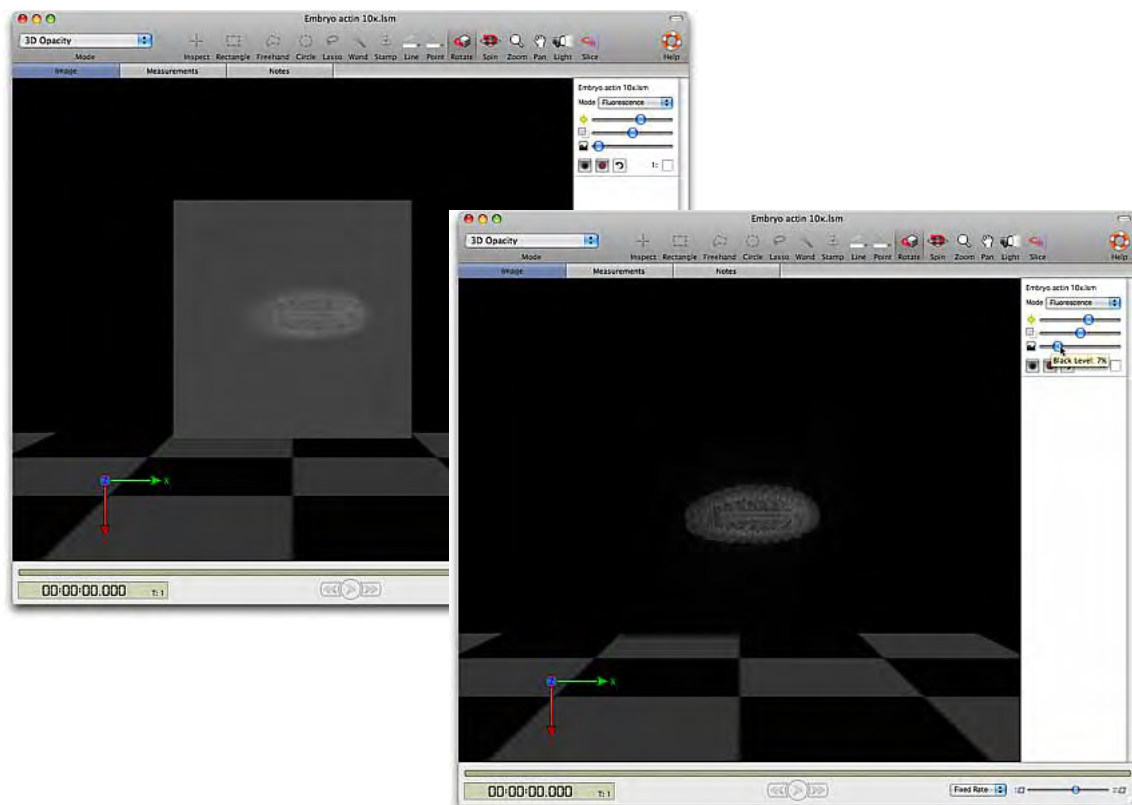



When choosing an appropriate black level, it may help to change the background color of the rendering view. Choose **View Options...** from the Image menu and choose a different color for the background (a lighter color usually helps the process). When the background color has been changed a dark area may be visible around the rendered object. Adjust the black level until this darkness is removed.

Leaving the cursor over any of the Renderer Controls momentarily brings up a tip showing their current values.

Move the volume in space using the tools available in the tool bar (see page 325).

 The show/hide button cloaks and uncloaks the channel in the Image View so you can choose to work with a channel or not.

 Target the channel for selection tools (see page 383).

 The reset button resets the slider button for that channel to default (the values it had when first opened).

The colored square reflects the color lookup table associated with the channel.

310 Improvisation

Reference Channels in 3D Opacity

3D Opacity mode supports the visualization of single plane reference channels within the volume. Reference channels will be shown at a single plane with a white outline in the position at which they were acquired.

Reference channels are 2D and are therefore rendered in a different way to 3D channels. There is no render mode (Fluorescence, Brightfield, Isosurface, Max Intensity) and slider controls only for brightness and density.

Time Navigation

Move through time resolved data in an image view using the time navigation controls across the bottom of the view. If these controls are not visible select **Show Time Navigation** from the Image menu.



Play the sequence back at a fixed rate or a multiplier of the real time as indicated by the timestamps of the data.

Set the mode of playback by selecting **Loop Sequence** or **Shuttle Sequence** from the Image menu. **Skip Timepoints** will miss out timepoints as necessary to maintain the frame rate set by the slider.

Using Contrast Enhancement with 3D Views

Changes made using the Contrast Enhancement dialog (Tools menu) are carried through into the 3D View. Remember that it is possible to alter the black point, white point and gamma of a dataset using the Contrast Enhancement and this will affect the appearance in the rendered view.

3D Ray Tracer

Unlike 3D Opacity which is a real time renderer that can be interacted with, the 3D Ray Tracer is not an interactive renderer. The screen image is built up in tiles over multiple passes. A progress bar in the top left-hand corner of the image shows progress to completion of the screen image. The quality of the image produced and the effects possible are different to those possible with the 3D Opacity renderer although the controls are similar. Please read the relevant section, starting on page 303.

3D Ray Tracer does not support tiled channels.

The Ray Tracer is a software renderer, which uses the computer processor or CPU to generate the results rather than graphics hardware.

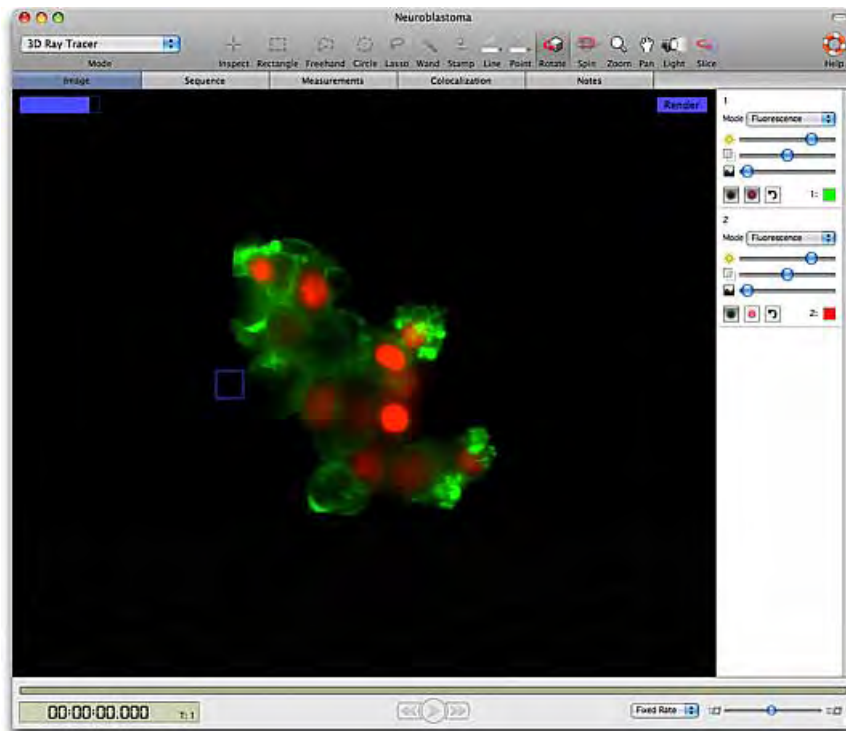

Using the tools in the toolbar to change the position or the orientation of the view will not update the view immediately; the view will switch to a wireframe representation of the volume that can be moved as required.

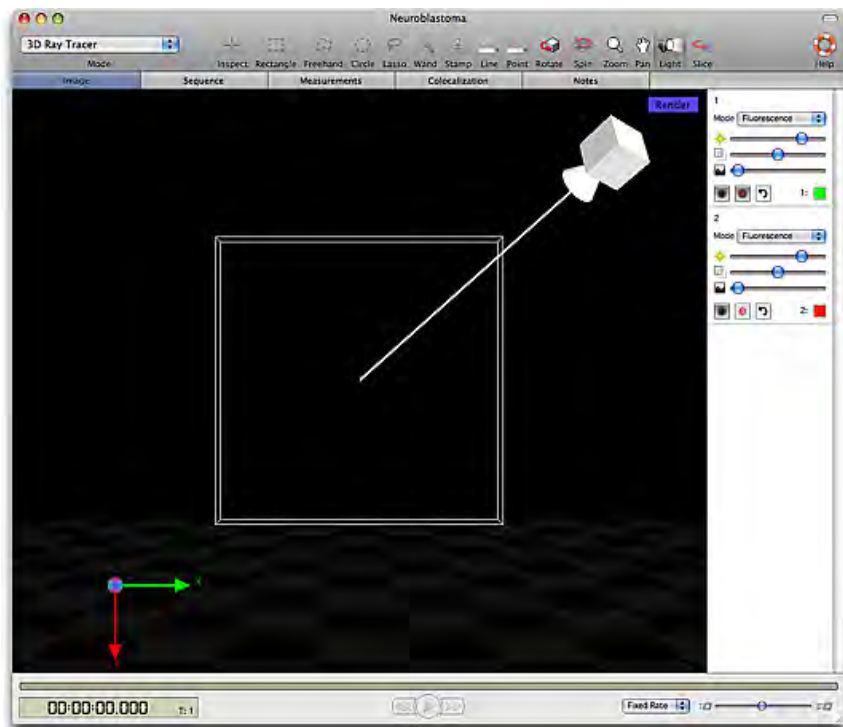

When the cursor is within the view a **Render** button is shown in the top right-hand corner. Click on this button to prompt the building of the screen image in tiles over multiple passes.

There is no need to wait for the image to build if you wish to make further changes; it is possible to interact with the menus, toolbar and channel controls while the image is being built. Click on the **Render** button to update the image with your changes.

Channel Controls

If the channel controls are not visible select Image menu, **Show Channel Controls**. There is a panel of controls for each channel in the data set. The first control is the Renderer mode. Within the same view individual channels may be set to any one of these modes. The modes available are described below:

- n **Fluorescence:** applies direct opacity rendering, which is designed for use on data from fluorescence microscopy.
- n **Isosurface:** applies indirect surface rendering, which identifies a surface around objects where all voxel intensity values are the same. This intensity is determined by the black level setting. The surface is made up of complex polygons. This generates apparently solid objects which cannot be seen through. No signal from objects behind can pass through an isosurface.

Fluorescence and Isosurface rendering modes in the Ray Tracer ensure compatibility for data which is also viewed using other renderers. The Ray Tracer offers further isosurface modes:

- n **Matte:** for a non-reflective surface.
- n **Metal:** gives the surface properties similar to that of metal, surfaces are shiny and may reflect properties of the surrounding scene, for example the color of the floor.
- n **Glass:** generates a surface which mimics the properties of glass. Objects can be given a high degree of transparency and there may be some reflection. Surfaces will be shiny.

Use the slider controls to control the brightness, density and black level of the rendered image.

- n **Brightness:** alters the brightness of the rendered voxels. A multiplication factor is applied to the intensity values of the voxels. Moving the slider to the left reduces the brightness, moving it to the right increases brightness.
- n **Density:** alters the density of the rendered voxels. This affects how much can be seen through the structure. Denser voxels do not allow signal from the objects behind to pass through to the screen image. Moving the slider to the right increases voxel density, moving it to the left decreases density.
- n **Black Level:** sets a value at which voxels of that intensity or lower will not be rendered. The remaining data is rescaled across the full display range of the screen. When choosing an appropriate black level, it may help to change the background color of the Rendering view. Choose **View Options...** from the Image menu and choose a different color for the background (a lighter color usually helps the process). When the background color has been changed a dark area may be visible around the rendered object. Adjust the black level until this darkness is removed.

Leaving the cursor over any of the Renderer Controls momentarily brings up a tip showing their current values.

The tools in the toolbar are described on page 325 an additional tool is available to you, the light source position.



Select this tool and click in the view, move the light position control. Ray tracing has the ability to cast shadows within the data and on the floor of the scene. It may be necessary to change the floor color to best show shadows on the floor. Do this using the **View Options...** dialog selected from the Image menu.

Switching views during tracing will cause the image to be lost and it will have to be traced again.

Note: The Ray Tracer does not currently support measurements feedback display or drawing of the scale grid in the Image view.

Reference Channels in 3D Ray Tracer

3D Ray Tracer mode supports the visualization of single plane reference channels within the volume. Reference channels will be shown at a single plane with a white outline in the position at which they were acquired.

Reference channels are 2D and are therefore rendered in a different way to 3D channels. There is no render mode (Fluorescence, Brightfield, Isosurface, Max Intensity). Slider controls in 3D Ray Tracer are otherwise the same as for 3D channels.

Improvisation Computing Server

3D Ray Tracing may be accelerated using the Improvisation Computing Server (ICS) to process the component tiles of the image. The data set is sent to each node of the ICS and Volocity requests processed tiles back.

3D Slice

The XY plane in which the images from a sample have been acquired may not always provide the best presentation of the structures being examined. It may be desirable to re-slice the image data in a different orientation in order to get the required view. 3D Slice and associated tools allow the reslicing of data sets in any chosen rotation of X, Y and Z.

3D Slice mode does not support tiled channels.

Before reslicing data ensure that the X, Y, and Z calibrations are correct in the item properties dialog, see page 63.

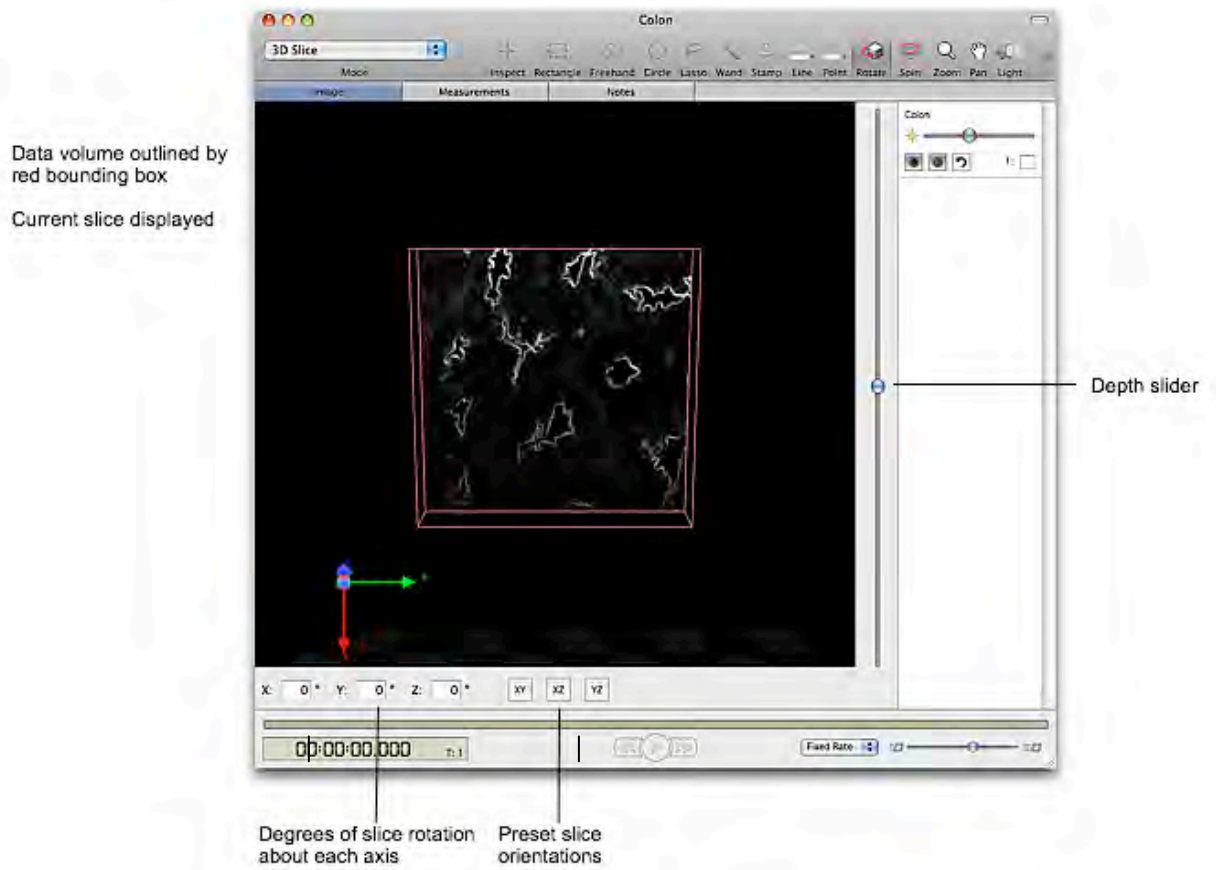

Enter Values to Set Slicing Orientation

You may either enter values for the X, Y, and Z values or use the buttons to step up and down. In order to achieve all possible orientations of the slice, the rotation should be considered to be first around the X axis, then around the new Y axis and finally around the new Z axis.

Use Preset Slicing Orientation

Click the Preset buttons to immediately set an XY, XZ or YZ slicing orientation.

When a slice orientation has been chosen, use the depth slider to the right of the view to see the slice moved through the volume. A tooltip for the slider will show the depth through the volume in microns. This value requires accurate calibration of the volume in the Properties dialog, see page 63.

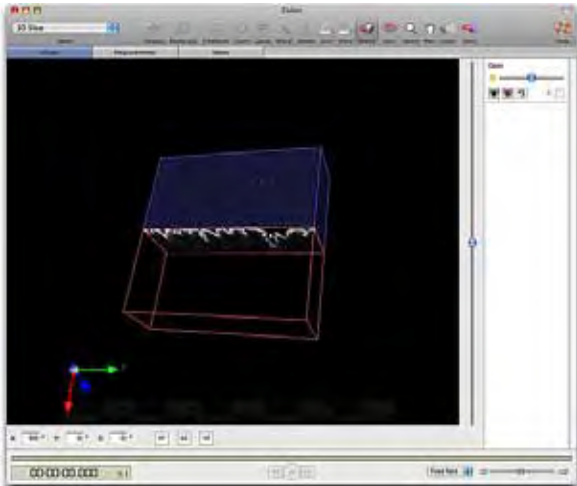

Slice moved to XZ orientation

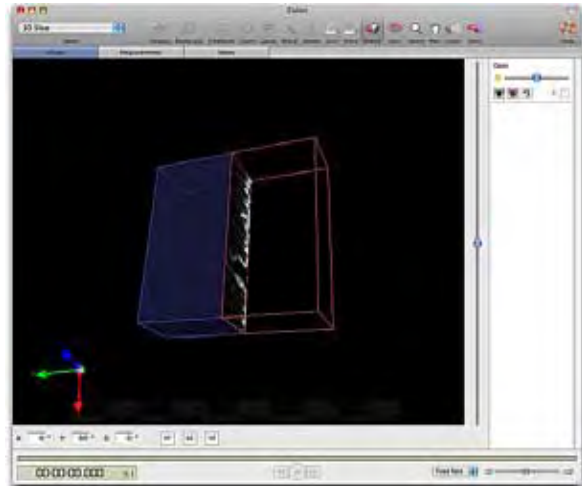

Slice moved to YZ orientation

Tools to Set Slicing Orientation



Rotate Slice, shortcut key, **S**.

The volume remains stationary and the slice is moved. The data shown in the slice will, therefore, be updated to show the changes in the slice.

3D Slice

The slice may be rotated through 360 degrees about all axes. A preview of the slice may be displayed in the top right-hand corner, select **Show Preview** from the Image menu.

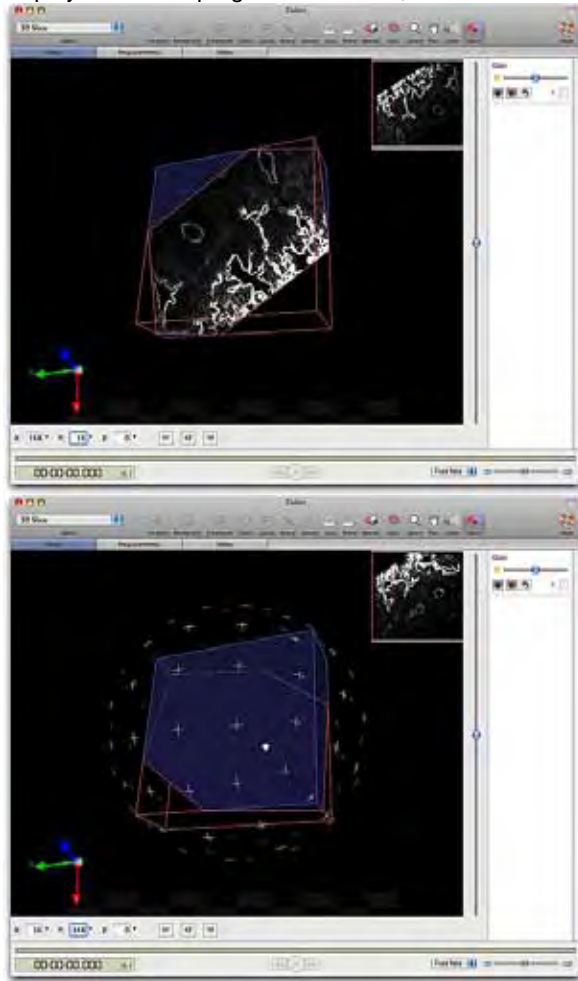



Rotate Volume, shortcut key, **V**.

Use this tool to rotate about the current slice (it is the volume that is rotated).

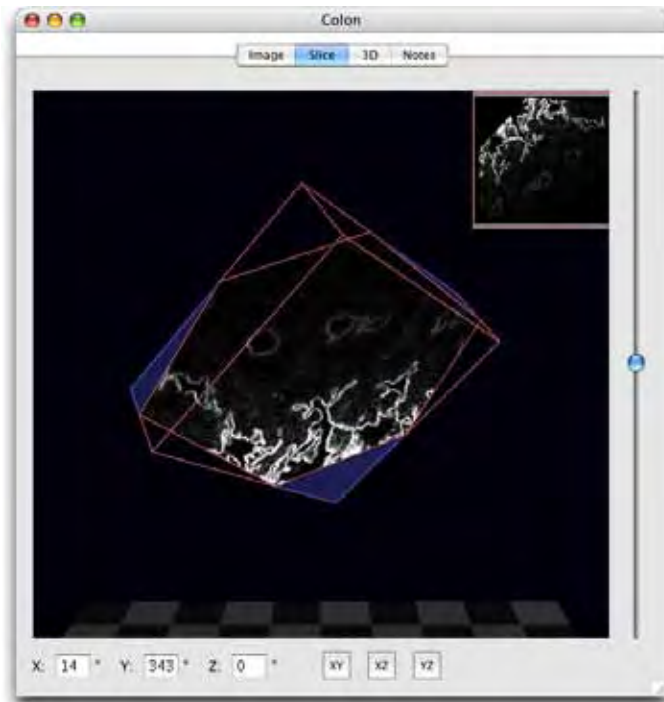

The slice remains stationary and the volume is moved. The data shown on the slice will update as the volume is moved through it. This tool can be used to allow constant viewing of the slice face while still changing the slice orientation.

When a slice orientation has been chosen, use the depth slider to the right of the view to see the slice moved through the volume. A tooltip for the slider will show the depth through the volume in microns. This value requires accurate calibration of the volume in the Properties dialog, see page 63.

Channel Controls and Time Navigation

Channel controls and time navigation are used with the slice view in the same way as for any other mode of the image view. If they are not visible select Image menu, **Show Channels** or **Show Time Navigation**.

Show Preview

Choose **Show Preview** to preview new slices that would be created, if the volume were to be sliced according to current settings. The slice preview is updated with the current slice when the depth slider is moved. Choose **Hide Preview** to remove the preview pane from the top right-hand corner of the Slice View.

To Create Data with New Slicing Orientation

Reslice Image from the Image menu creates a new volume or image sequence with each slice at the new orientation. The volume will typically be larger than the original. Any offset slices will be drawn around to avoid cutting off data.

- n Resliced volumes are interpolated using tri-cosine interpolation so that each axis has the same calibration as the highest resolution axis in the original data. Calibration will be changed accordingly. The overall dimensions of the data set will not change and calibrated measurements, such as the volume in square microns, will be the same. Non-calibrated measurements, such as voxel counts, will not be the same as the original data.
- n Calibrate data before slicing; corrections on sliced data will not be easy to calculate.
- n Rendered views of sliced and unsliced data will look identical.
- n The mean intensity of objects will not be changed. Individual voxels may have altered intensity values because of interpolation.

Reslice Image to Folder creates a folder of images at the new slicing orientation.

Capture Snapshot

This option adds a new 2D image to the library showing the view as it appears when the snapshot is captured.

Show/Hide Floor, Scale, Orientation

These options change the display of the Slice View. It is possible to show a scale grid and orientation tool as in the Rendering View, see page 324.

View Options

These options change the color of the scale grid and Slice View background to clearly display data.

Reference Channels in 3D Slice

Reference channels are single images within a 3D data set. 3D Slice mode shows the reference image only at the z location where it exists. Depending on the orientation of the slice and the position in z of the current view point a reference image may not be visible.

Image Menu

Commands found in the Image menu, of particular reference to Volocity Visualization, are described here. These include controls that allow you to show/hide elements of the view and to apply special effects.

Mode

Allows selection of how the data is viewed in the Image view. The options added by Volocity Visualization are:

- n 3D Opacity
- n 3D Ray Tracer
- n 3D Slice

The mode is also set using the popup in the tool bar.

Stereo

This option allows selection of a stereo mode of viewing which will generate the image so that it is viewed with specialized glasses to emphasize the 3D appearance.

Show/Hide Channels, Bookmarks, Movie, Time Navigation

These are parts of the view that may or may not be used depending on the work that you are doing therefore you may wish to hide them from view to give more space to the image. Channel controls and Time Navigation are shown by default. Bookmarks and Movie will need to be shown when they are first required.

Capture Snapshot

This option creates a 2D image of the view as it currently appears. This image may then be exported.

Create QTVR Movie...

This option creates a specialized movie which can be viewed using a QuickTime player. Rather than playing back frames through time, different orientations of the view are captured and viewers of a QTVR movie may manipulate the object themselves within the limits of range of movement set when making the movie. QuickTime must be installed on the system for this option to be available.

Show/Hide Scale

Scale is shown using a grid behind the object. The grid moves to stay behind the object as it is rotated. The distance represented by each square in the grid, the calibration information, is shown in the bottom right corner of the screen.

Use the Scale tab in the **View Options...** dialog to change the color of the scale grid and switch calibration information on or off.

Show/Hide Floor

A floor is shown below the object in the 3D View to emphasize the orientation of the object. **Hide Floor** becomes **Show Floor** when the floor is not visible. Use the **View Options...** to change the position and appearance of the floor.

Show/Hide Orientation

Orientation is a marker to identify x, y, and z axes. This multi colored pointer is shown in the bottom left hand corner of the view

Show/Hide Time

Select **Show Time** from the 3D menu to display the volume timestamp. Change the color of the timestamp or frame time in the View Options.

Always Show Ball

This option always displays the graphical ball which is used to move the object around in the view.

Reset View

This option resets the orientation of the object to the default position applied when the data is first seen in the 3D View.

View Options

Use the **View Options...** command to change the setup of the 3D View. The dialog is tabbed for different settings.

In the **General** tab change the background and/or floor color. Using different colors for these can improve the visibility of details in the data being rendered. Floor position and also pattern can be changed. The **3D Scale** tab changes how the scale grid is drawn.

Image Toolbar

Rotate Object



Shortcut key R

Use this tool to rotate the object. A ball outlines the object and the pointer changes to a hand when you position it on the object. When you let go, the object spins around the pivotal point.

Use Alt-click (Mac) or Ctrl-click (WINDOWS) and drag to zoom.

Use Shift-click to move the camera, or view, position.

Spin Object



Shortcut key F

Use the Spin tool to move the camera, or view, position.

Use Alt-click (Mac) or Ctrl-click (WINDOWS) and drag to zoom.

Use Shift-click to move the object.

Zoom



Shortcut key Z

Use to zoom.

Pan



Shortcut key H

Use the pan tool to move the object inside the ball control. For example, this allows you to set the pivotal point for rotation, as described in the next section.

Light Source



Shortcut key G

Use the light source tool to move the source of illumination in the scene. Currently supported for Ray tracing and isosurfaces in 3D Opacity rendering.

Rotate Slice



Shortcut key E

Use the rotate slice tool when viewing data in the 3D slice mode to change the orientation of the slice in the volume.

Setting the Pivotal Point of Rotation

1. Click and drag within the ball with the hand tool to center the object on the first axis.
2. Change to the rotate tool to check the effect.
3. Continue to adjust for each axis, using the hand tool, until you have set the pivotal point of rotation, as required.

Note: Select **Reset View** from the Image menu to return the object to its original position.

Free Flight Camera Control

It is possible to control the viewing point or camera position for free flight around and through the volume. This is achieved using a USB joystick/gamepad with two analog joysticks and front face buttons.

Joypad Preferences

It is important to enable the joypad and calibrate the sticks before using the joypad for the first time.

1. Select **Preferences...** from the Edit menu (Windows) or the Volocity menu (Mac).
2. Click on the **Joypad** icon.
3. Check to **Enable Joypad Control**, select the **Device** and **Calibrate** both sticks.

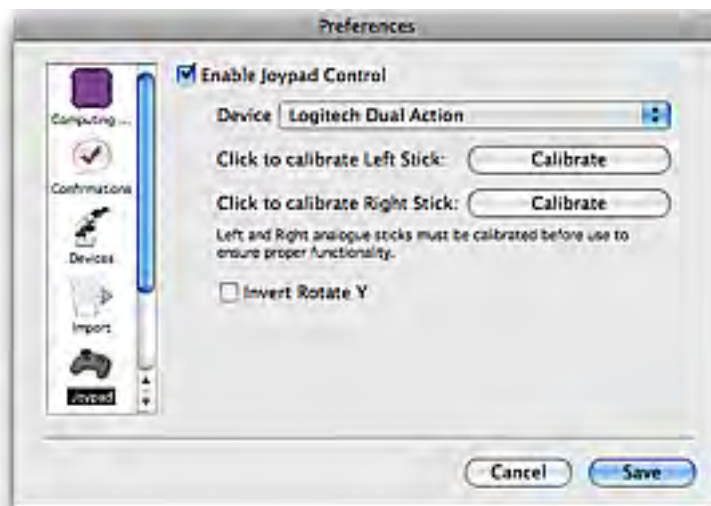

Controlling the Joypad

The gamepad controls the camera or viewer position allowing completely free movement around and through the volume. The gamepad is, therefore, not moving the object at all.



Left Analog Stick

Move left, right, forwards and backwards

Top Left Shoulder Button

Modifies action of left analog stick

Move up and down

Numeric Buttons

1 Point at center of volume

2 Add bookmark

Right Analog Stick

Turn left, right, up and down

Top Right Shoulder Button

Modifies action of right analog stick

Roll left and right

3D Image Bookmarks

Bookmarks allow you to store information about the position of the volume and the rendering settings being applied to it. Bookmarks operate in any mode of the Image view.

Bookmarks do not store the status of overlays on the image such as time or scale, nor will they store and therefore turn on or off any measurement feedback that may be shown in a view when the bookmark is made.

Bookmarks can be used to remember these settings so that they may be retrieved later. For example, to return to a previous position and appearance after making changes or to use the position and appearance of one data set to view another data set with exactly the same settings applied.

To Create a Bookmark

Bookmarks are kept in a Bookmark pane to the left of the Image View. If this pane is not visible, select **Show Bookmarks** from the Image menu.

- n Position the volume as required and set the channel controls to produce the desired appearance.
- n Select **Add Bookmark** from the Image menu or use the shortcut Ctrl+ B on Windows, Apple+B on Mac OS.

A thumbnail of the volume will be added to the bookmarks pane.

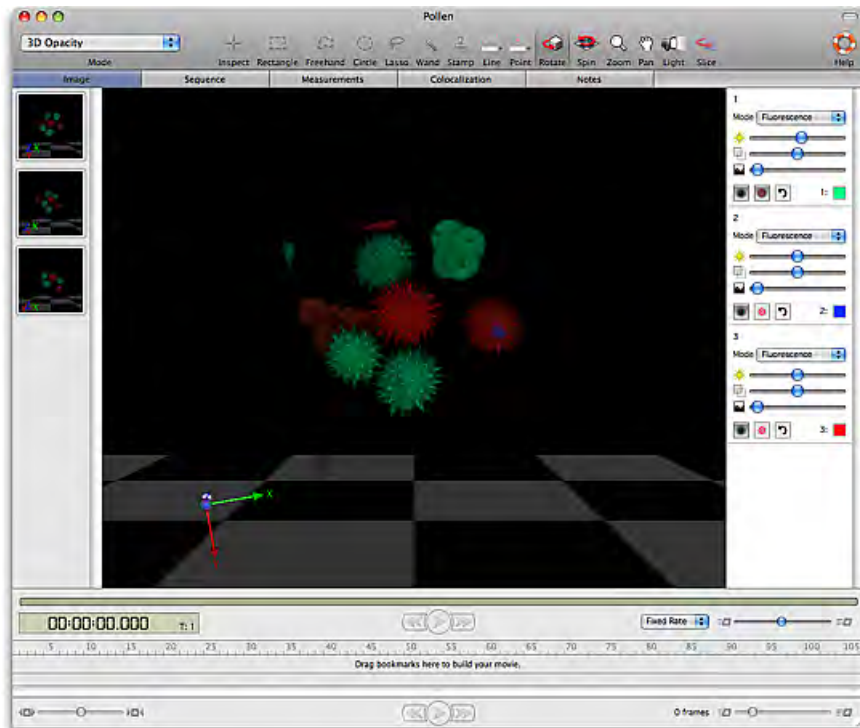

To Use a Bookmark

Double click on the thumbnail of a bookmark in the bookmark pane to use the settings of that bookmark to change the position and rendering settings of the current Image View to those stored by the bookmark.

Alternatively use **Next Bookmark** or **Previous Bookmark** in the Image menu to step through bookmarks in the order in which they were created.

To Edit a Bookmark

1. Select the bookmark in the bookmark pane, the borders of the bookmark will become highlighted.
2. Select **Edit Bookmark...** from the Image menu.
3. A dialog is opened showing the states of the view that are being stored.

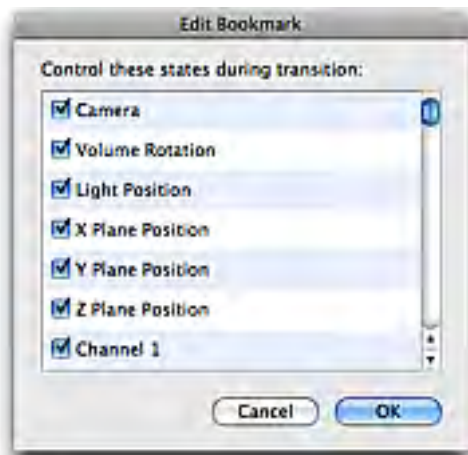

4. Uncheck a state and that particular bookmark setting will not be applied to the Image View when the bookmark is used.

Check the state again and the setting(s) stored when the bookmark was created will be applied again when the bookmark is used.

To Move a Bookmark.

To use the settings of one Image View with another data set so that both data sets may be compared move the bookmark from the first Image View to the second.

With both data sets open drag the bookmark from one bookmark pane to the other.

The bookmark thumbnail will update the first time it is used with the new dataset.

To Delete a Bookmark

Select the bookmark in the bookmark pane, the borders of the bookmark will become highlighted.

Use the Delete (Windows) or Backspace (Mac OS) keys to delete the bookmark.

Overlays turned on or off by items in the Image menu, i.e. the ball control, scale, orientation and time, are not stored by bookmarks.

3D Image Movie Interface

Bookmarks are the starting point for making movies to animate 3D images. The movie will be an animation of the transition between the appearance of the volume in one bookmark and its appearance in the next bookmark. Each transition takes place over a number of frames determined by you. Select **Show Bookmarks** from the Image menu to view the bookmarks pane.

1. Choose **Show Movie** from the Image menu.

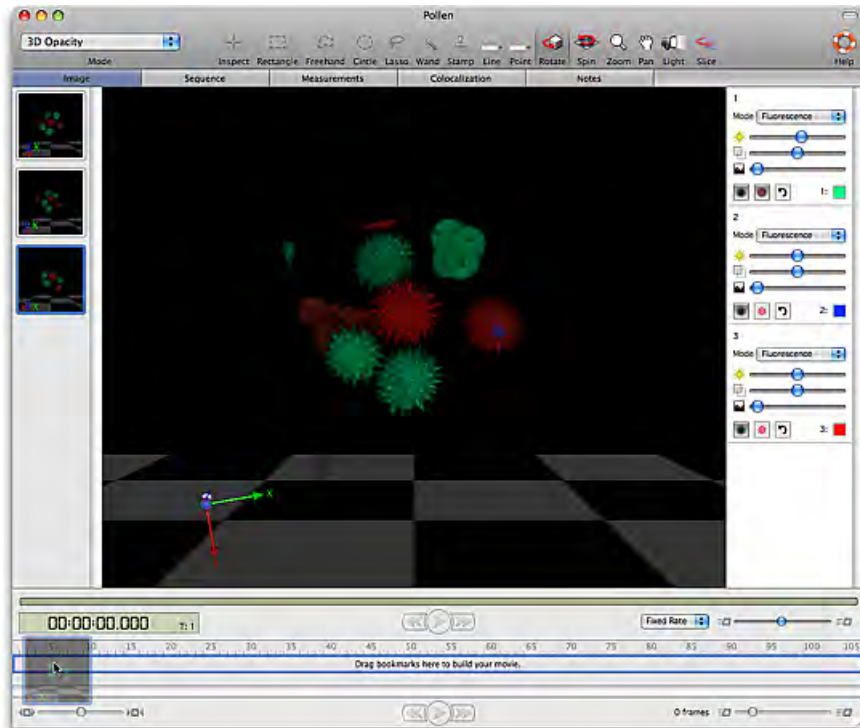

2. Drag a bookmark thumbnail from the bookmark pane to the movie pane to create a keyframe in the movie. By default this keyframe will be 10 frames long. Keyframe length may be changed by clicking and dragging the end of the keyframe.

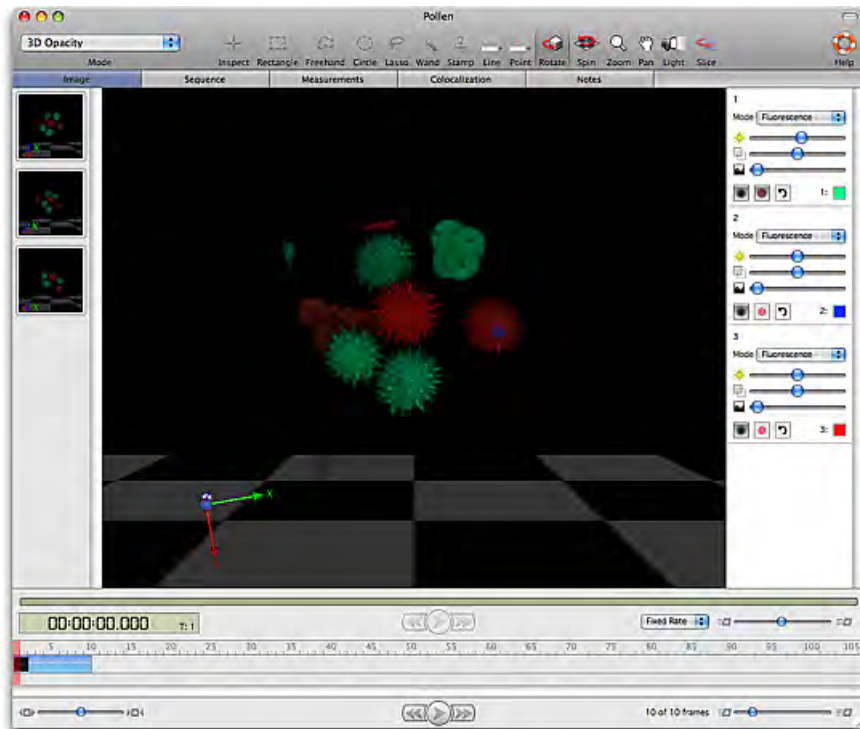

3. Drag a second bookmark into the movie pane. When the movie plays, the volume will be gradually changed in appearance from the first bookmark to the second, this transition taking as long as the number of frames over which the first keyframe extends.

3D Image Movie Interface

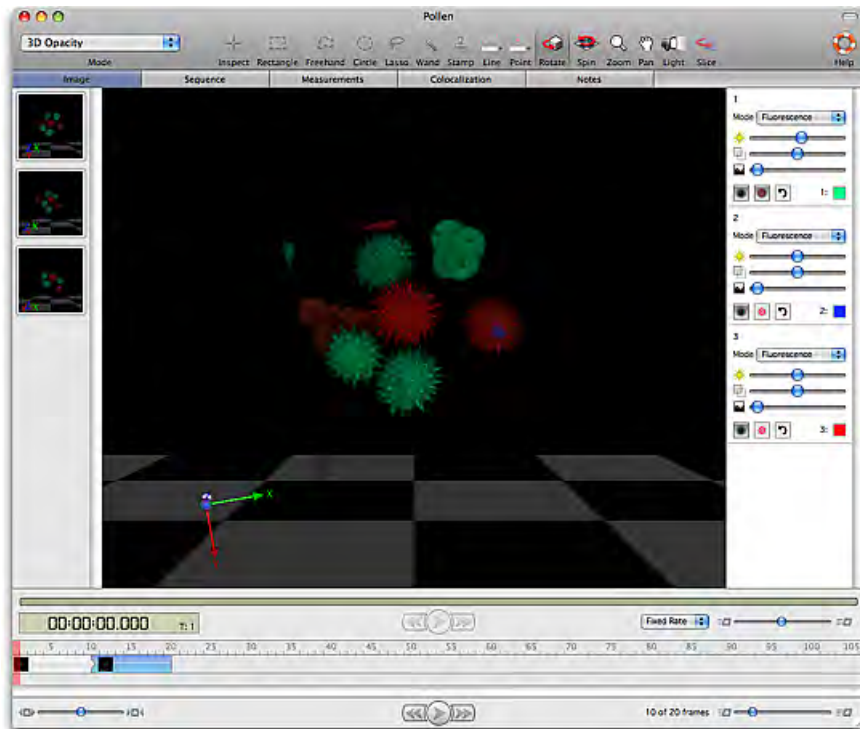

4. Continue dragging bookmarks in to make a series of keyframes/transitions. Preview the movie, in the current Image view by using the lower set of controls on the view.

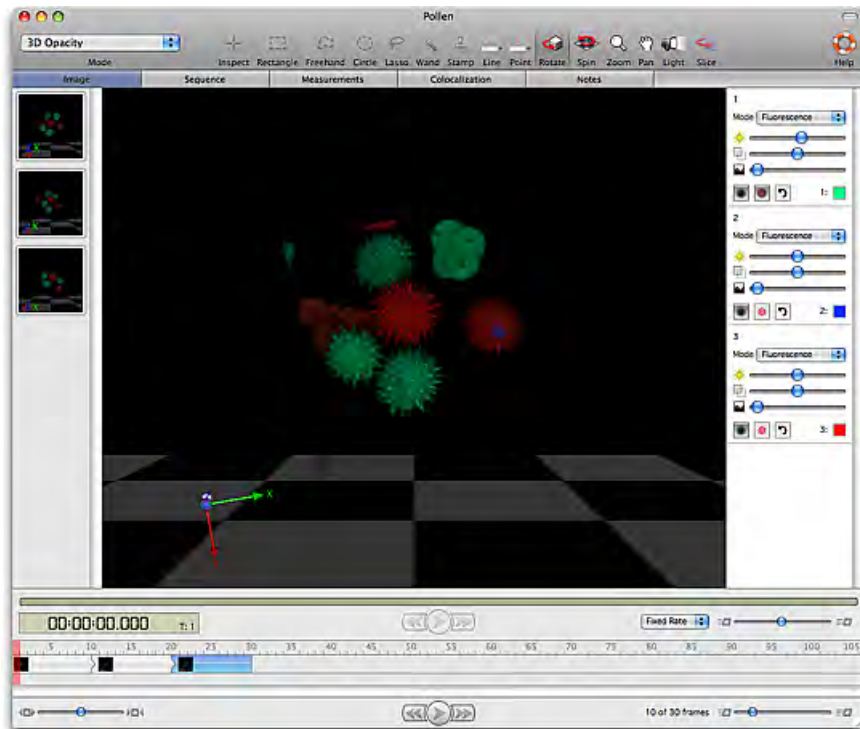

5. To include switching between timepoints in a movie made for a time resolved sequence select **Add Timepoint Sequence...** from the Movie menu.

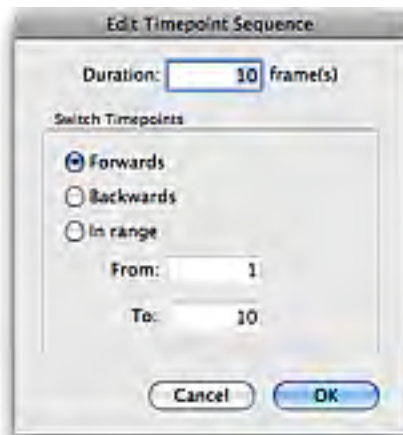

Configure the dialog so that the timepoint sequence lasts the required number of frames, switching between timepoints backwards or forwards and even switching between a subset of timepoints.

This will add a time bar to the movie. Delete a keyframe from the movie by clicking on it once to select it then using the Delete key (Windows) or the Backspace key (Macintosh)

6. Preview the movie on the current Image View using the lower set of playback controls.

Edit Keyframe

Double click on a keyframe or select **Edit Keyframe...** from the Movie menu to access the Edit Keyframe dialog.

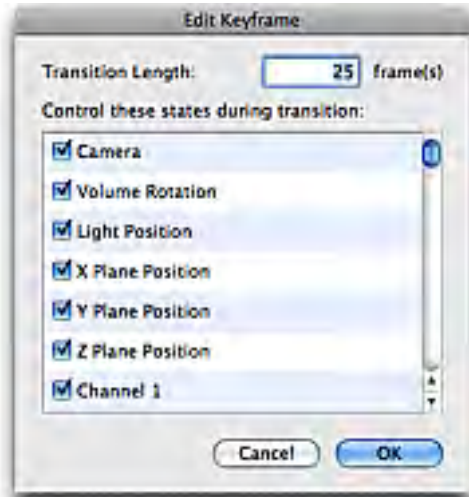

This dialog allows configuration of the length of the keyframe transition and also selection of the bookmark properties which are used in that transition. It is, therefore, possible to use only the positional information and not the rendering settings stored with a keyframe.

Edit Timepoint Sequence

Double click on a timepoint sequence or select **Edit Timepoint Sequence...** from the Movie menu to access the Edit Timepoint Sequence dialog.



Adjust the number of frames over which the timepoints will be played through, switch between timepoints backwards or forwards.

You can also use this dialog to configure a timepoint sequence to switch between a subset (or range) of timepoints. Additional timepoint sequences may be added to the movie to switch through remaining timepoints.

Resize Movie

Select **Resize Movie...** from the Movie menu to easily change the length of the movie. Movie length may be changed to a percentage of its existing frame number, to a fixed number of frames or to last a known length of time when played at a known frame rate.



Clear Movie

Select **Clear Movie** from the Movie menu to delete all the keyframes and timepoint sequences of a movie.

Make Movie

Once a movie is created you may wish to generate the frames of the movie for the current Image View to then be able to export them. Select **Make Movie** from the Movie menu to create the movie frames and add them to the library as new image sequence. This new sequence will have the same name as the source data with **Movie** appended. View and work with this sequence in the same way as any other.

This folder may be exported as a movie by selecting it and choosing **Export...** from the File menu.

Save and Restore Movie

It may be relevant to save this movie for future use and for use with different data sets.

Save the movie keyframes by selecting **Save Movie...** from the Movie menu. Give the movie a name and click **Save**. This will store the movie as a preference within the system.

To use a movie previously stored on the system Select Movie menu, **Restore Movie...**Select the movie name from the list and click **Restore**.

To make standard movements such as rotation about an axis use one of the stored movies supplied with Volocity. Select Movie menu, **Restore Movie...** to open one of these in your movie.

Use existing movies with a data set by viewing the Image View and selecting **Restore Movie...** from the Movie menu.

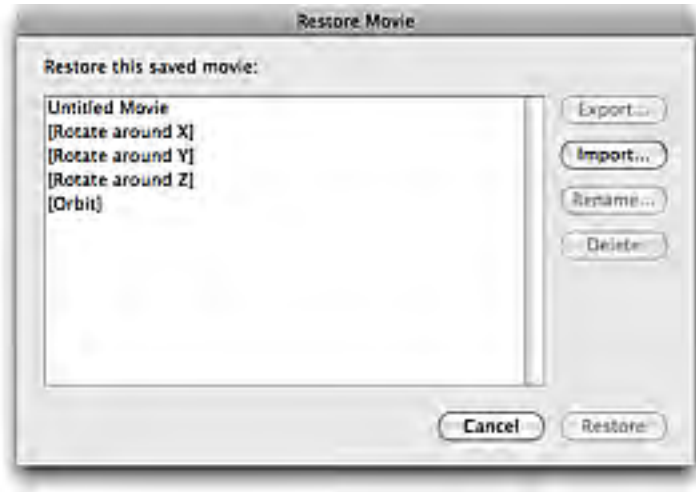

Creating QuickTime VR Movies

A QTVR file is an interactive movie that can be viewed in QuickTime player. If you have QuickTime installed on your machine, you can render a volume and then create a QTVR movie of the rendered view.

Note: A QuickTime VR movie is not a real movie, as such, rather an animation that is created by displaying the object according to a map of user-defined co-ordinates.

1. Select **Create QTVR Movie...** from the Image menu

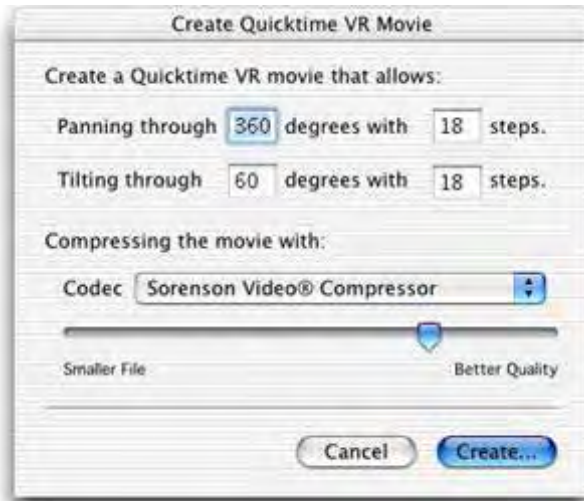

2. Amend the settings as appropriate.
3. The panning and tilting values define the rotation that can be applied to the QuickTime object. These values are used to build a map of all the co-ordinates that will be used to display the object on the screen. In our example, you will be able to rotate the object 360 degrees in 18 steps and tilt it through 60 degrees in 18 steps (this means the object will rotate 3 degrees for each step).
4. Select a compression format from the drop-down list and use the slider control to set the compression factor.
5. The available compression options vary according to the version of QuickTime that is installed
6. Click on **Create...**
7. Select a folder and enter a name for the movie.
8. Click on **Save**.

Aligning Volumes

The Volocity alignment tool is designed to compensate for rotational and translational shifts only between the 2-dimensional planes that make up a volume.

When performing rotational correction the Alignment tool will search for correlation +/- 30 degrees from the origin. The Alignment tool searches for correlation between slices in the data to match features and establish where each slice should be in relation to the next. For alignment to be successful features must be represented in neighboring slices. This means that the slices must be similar.

The Alignment tool will not work on structures that are, or approximate to, spheres, since they show rotational symmetry which makes feature matching impossible.

During rotation of images anti-aliasing is applied which has a smoothing effect on the data. The original data is not overwritten, a new volume or volume sequence is created with the suffix (aligned). The XY dimensions of an aligned volume will be the same as the original volume, areas of image that have been shifted outside the original boundary to allow alignment will be cropped from the result.

There is no benefit to be gained by repeatedly aligning the same data.

1. Select **Align Volumes...** from the Tools menu.
2. If you are aligning images in an image sequence, a prompt will be shown offering options to align volumes individually or using a selected channel in the sequence as a reference.

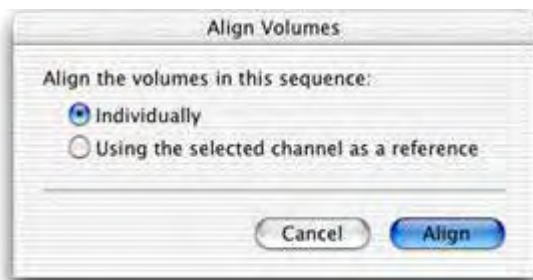

3. If no channel has been selected, or if you have selected more than one channel, only **Individually** is available. If a channel has been selected, you can click on either button. Click **Align**.

Volocity Quantitation Worked Examples

Overview

Volocity Quantitation is a separate product in the Volocity family. See page 38 for more information about activating additional products after installation. Volocity Quantitation is designed to identify biological structures automatically. These can then be measured and tracked in 2D, 3D and 4D, analyzed and charted. Volocity Quantitation is an individual product and must be purchased separately. See page 38 for more information about activating extension products.

Volocity Quantitation provides a powerful, easy-to-use interface that allows the user to build up protocols of measurement tasks and then view the feedback as an overlay on the original image and view a table of measurements – all from the same Measurements view.

The Measurements view provides all the tools required to identify objects and make a variety of measurements from those objects. Measurements made in the Measurements view can also be stored as a new item in the library by using **Make Measurement Item...** in the Measurements menu.

To assist users wishing to start working immediately, this chapter provides five worked examples describing common applications using Volocity Quantitation:

- n Measure the mean volume of structures in a 2-channel data set at a single timepoint.
- n Measure multiple timepoints.
- n Measure multiple image sequences.
- n Measure and track multiple timepoints.
- n Colocalization.

For more detailed information on the tasks and tools available in Volocity Quantitation please see the separate reference chapter, starting on page 376.

Measuring a Single Timepoint

The process has three stages:

- n Create a protocol to locate objects of interest in your data set. A protocol is used to threshold data to select areas of interest and, from that selection, include or exclude objects based on a range of criteria.
- n Create a Measurement Item to store the measurements.
- n Review the results.

To obtain correct values for calibrated spatial measurements, it is important to ensure that the data is calibrated correctly by setting the X, Y and Z pixel dimensions in the Properties dialog, see page 63.

Creating the Measurement Protocol

1. Open the required data set and view the Measurements tab. The Measurements View contains all the tools and information needed for selecting objects.

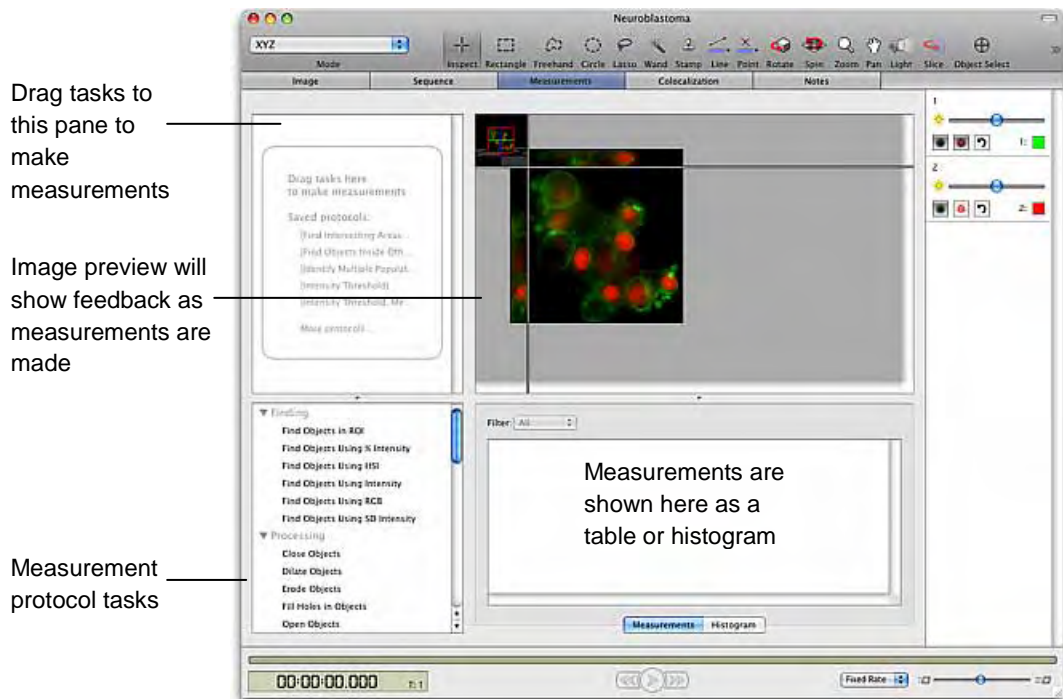

2. Start the protocol by using a Finding task such as **Find Objects Using Intensity**. There are other Finding tasks which may be appropriate for different types of data. See instructions for each task starting on page 400. If the dataset contains more than one channel, as in this example, make sure that the correct channel is selected in the task.

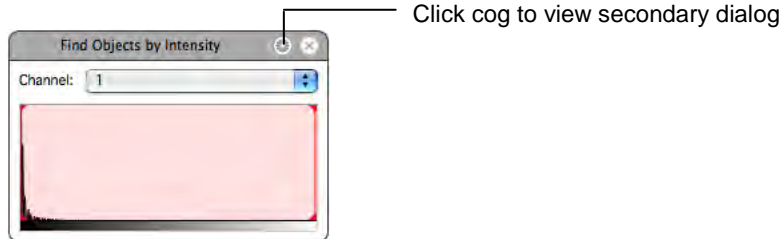

3. The task shows a histogram of the intensity values present within the data set and selected values are shown as a shaded red area on the histogram. Drag the vertical, red lines to adjust the intensity range selected.
4. The selected objects will be shown as a colored overlay in the image preview and standard morphological and intensity measurements will be displayed in the measurements table. To change the color of objects found use the **Color Objects** task, see page 419, and to change the measurements made use the **Measure Objects** task, see page 417.
5. If the selected objects are not automatically shown, select **Update Feedback** from the Measurements menu. To update feedback automatically after any change to the protocol turn on **Automatically Update Feedback** in the Measurements menu.

6. If too many or too few objects have been selected you may need to make adjustments to the protocol.
 - n **Find Objects.** The protocol will only select voxels if they are between the minimum and maximum intensity set in the task. Drag the red bars to include more or fewer voxels. Click on the cog icon on a task in the protocol to access the secondary dialog for the task.

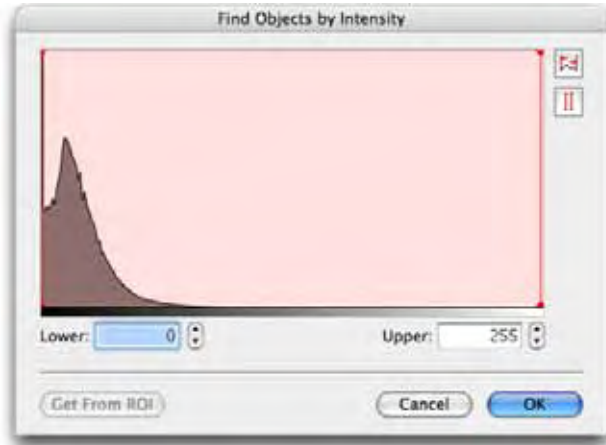

This dialog shows a larger histogram and value entry fields for more precise setting of threshold values. It is also possible to set the thresholds to the maximum and minimum intensity values found within a region of interest drawn on the image. The ROI must be drawn before this dialog is opened. Click **Get From ROI**.

- n **Modify the Selection.** It may be necessary to remove noise from the selection to avoid selecting voxels that are not relevant to the objects required. Add a **Remove Noise From Objects** task to the protocol and select the size of filter to be applied.

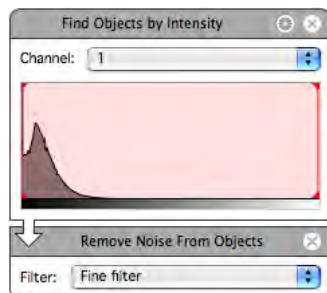

- n **Exclude Objects.** It is also possible to exclude objects based on certain characteristics such as their size, shape or position relative to the edge of the image or an ROI. Use the table of measurements to make decisions about this step. To order the measurements by size to help choose sizes to exclude click on the column heading for Volume (or Area) and the column will be

reordered by that value. Add an **Exclude Objects by Size** task to the protocol to exclude objects larger or smaller than the size entered.

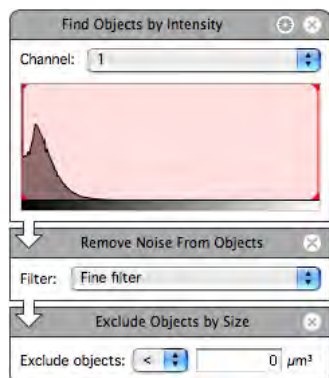

6. Adjust the protocol, as required, until the preview shows the required selection.
7. If the table does not show the measurements required, or shows too many, add task(s) from the Measuring category to the protocol. Click on the cog icon in a Measure task to set up the measurements required. For example the **Measure Objects** task dialog will look like this:

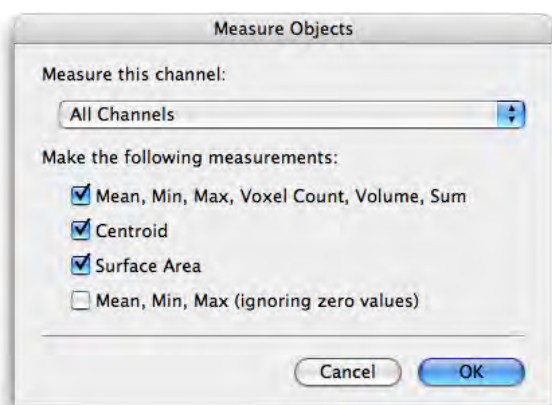

8. If you wish to save the protocol for future use, select **Save Protocol...** from the Measurements menu.

Storing Measurements in a Measurement Item

1. The measurements visible in the Measurements View are present because a protocol is active in the Measurements View. As soon as the protocol is changed the measurements will change. To store measurements and work with them further, you must create a Measurement item.
2. Select **Make Measurement Item...** from the Measurements menu.

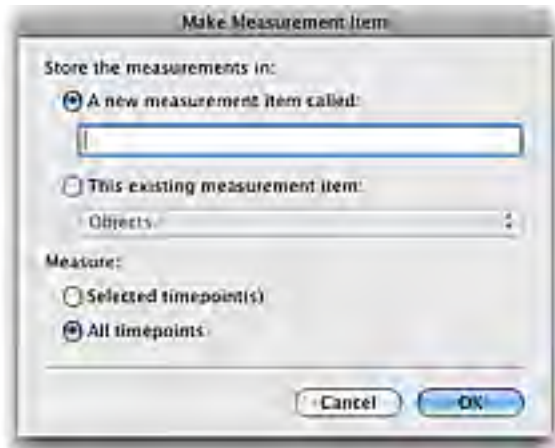

3. Select to make a new measurement item and enter a name for it, or add these measurements to an existing table, which may be made from the same data or from different data. Measurement items may combine measurements from different sources. Measurements may be made all on timepoints or selected timepoints. If no timepoints are selected the current timepoint is measured.
4. Click on **OK**.

A progress bar may be shown on screen while the measurements are being made. A new item will be added to the library.



Viewing the results

1. Double click the Measurement item to open the Raw view showing the table of numbers.

This table may be sorted, re-organized and filtered. See page 429 for more information on working with the Raw View.

If required, the measurements may be exported as tab or comma-delimited text. To do this, display the Raw View and select **Export...** from the File menu.

Measuring Multiple Timepoints

The process has three stages:

- n Create a protocol to locate objects of interest in your data set. A protocol is used to threshold data to select areas of interest and, from that selection, include or exclude objects based on a range of criteria.
- n Create a Measurement Item to store the measurements.

- n Review the results.

To obtain correct values for calibrated spatial measurements, it is important to ensure that the data is calibrated correctly by setting the X, Y and Z pixel dimensions in the Properties dialog, see page 63.

Creating the Measurement Protocol

1. Open the required data set and view the Measurements tab. The Measurements View contains all the tools and information needed for selecting objects.

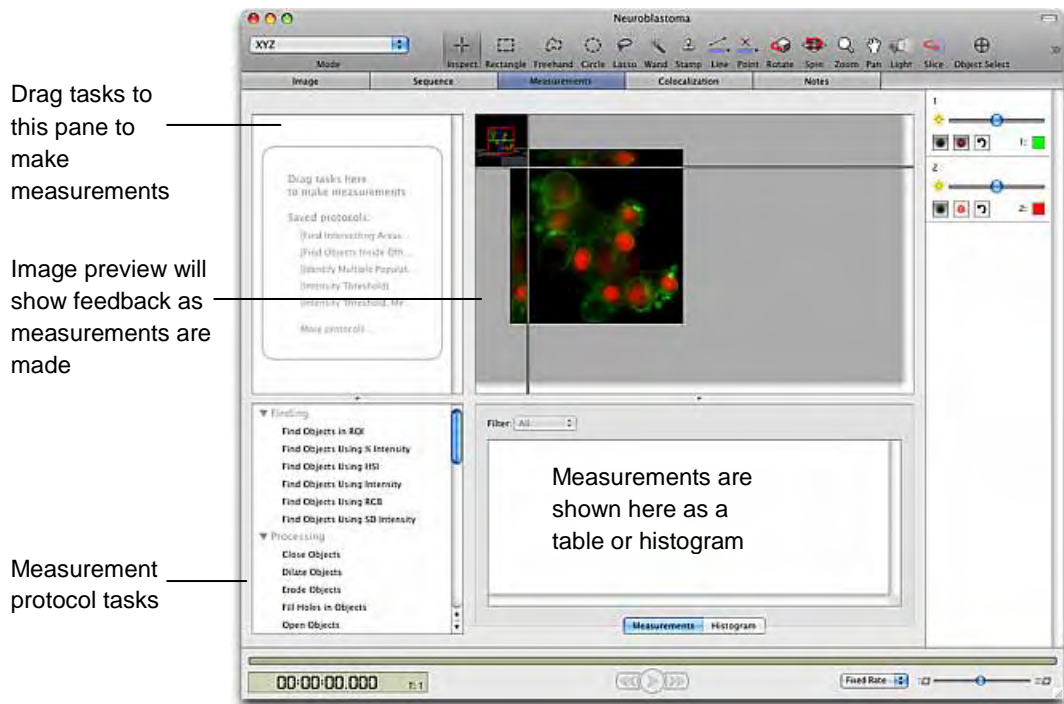

2. Start the protocol by using a “Find Objects” task such as **Find Objects Using Intensity**. There are other “Find Objects” tasks which may be more appropriate for time resolved data (for example, **Find Objects by % Intensity** and **Find Objects by SD Intensity**). These tasks do not use absolute intensity values and are, therefore, better suited to data where the range of intensity values does not remain constant. See instructions for individual tasks starting on page 400. If the dataset contains more than one channel, make sure the channel containing the objects required is selected in the task.



3. The task shows a histogram of the intensity values present within the data set; selected values are shown as a shaded red area on the histogram. Drag the vertical, red lines to adjust the intensity range selected.
4. The selected objects will be shown as a colored overlay in the image preview and standard morphological and intensity measurements will be displayed in the Measurements table. To change the color of objects found use the **Color Objects** task, see page 419, and to change the Measurements made use the **Measure Objects** task, see page 417.
5. If the selected objects are not automatically shown, select **Update Feedback** from the Measurements menu. To update feedback automatically after any change to the protocol, turn on **Automatically Update Feedback** in the Measurements menu.
6. If too many or too few objects have been selected, you may need to make adjustments to the protocol.
 - n **Find Objects.** The protocol will only select voxels if they are between the minimum and maximum intensity set in the task. Drag the red bars to include more or fewer voxels. Click on the cog icon on the task in the protocol pane to view the secondary dialog.

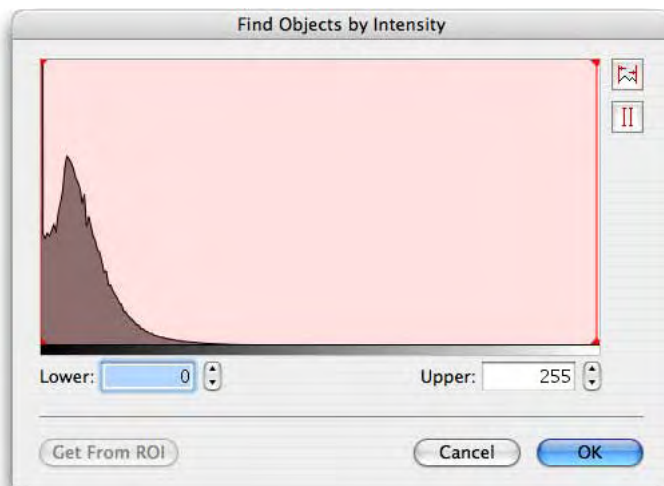

This dialog shows a larger histogram and value entry fields for more precise setting of threshold values. It is also possible to set the thresholds to the maximum and minimum intensity values

found within a region of interest drawn on the image. The ROI must be drawn before this dialog is opened. Choose **Get From ROI**.

- n **Modify the Selection.** It may be necessary to remove noise from the selection to avoid selecting voxels that are not relevant to the objects required. Add a **Remove Noise From Objects** task to the protocol and select the size of filter to be applied.

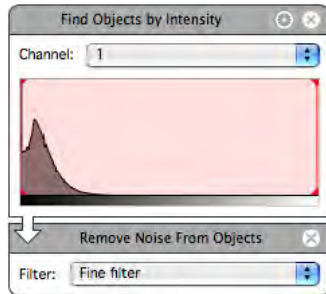

- n **Exclude Objects.** It is also possible to exclude objects based on certain characteristics such as their size, shape or position relative to the edge of the image or an ROI. Use the table of measurements to make decisions about this step. To order the measurements by size to help choose sizes to exclude click on the column heading for Volume (or Area) and the column will be reordered by that value. Add an **Exclude Objects by Size** task to the protocol to exclude objects larger or smaller than the size entered.

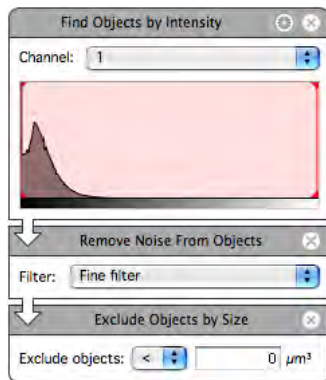

- n Adjust the protocol, as required, until the preview shows the required selection.

Storing Measurements in a Measurement Item

1. The measurements visible in the Measurements view are present because a protocol is active in the Measurements view. As soon as the protocol is changed, the measurements will change. To store measurements and work with them further, you must create a Measurement item.
2. Select **Make Measurement Item...** from the Measurements menu.

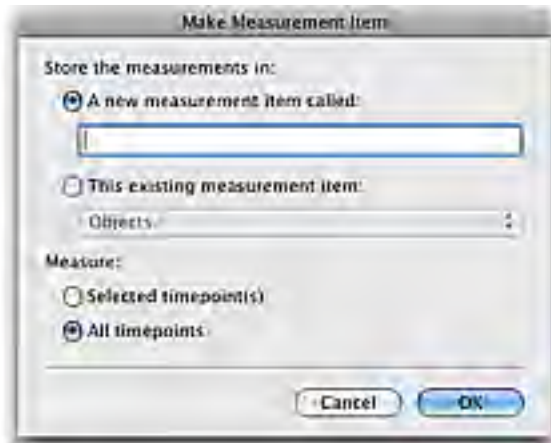

3. Select to make a new Measurement item and enter a name for it, or add these measurements to an existing table, which may be made from the same data or from different data. Measurement items can combine measurements from different sources. Measure all timepoints or a selected subset of timepoints.

4. Choose to measure **All timepoints** and Click on **OK**.

A progress bar may be shown on screen while the measurements are being made. A new measurement item will be added to the library.

Viewing the Results

1. Double click the Measurement item to open the Raw View showing the table of numbers.
This table may be sorted, re-organized and filtered. See page 429 for more information on working with the Raw View.
If required, the measurements may be exported as tab or comma-delimited text. To do this, display the Raw View and select **Export...** from the File menu.
2. The Analysis View may be used to show relationships of data over time, for example the mean intensity of measured objects for each timepoint. Click on the Analysis tab and select **Analyze...** from the Analysis menu.



The data of interest is the mean intensity for each object. Therefore select the column heading for the mean intensity of the channel of interest in **Analyze these data**:

There are several objects per timepoint, so **Summarized by:** Mean will find the mean of the value for each object. **Organize the data by:** Row set to Timepoint



The Analysis view now shows a table with the mean of the mean intensities arranged in rows according to timepoint.

Timepoint	Mean of Mean
1	45.2106
2	43.153
3	41.2418
4	40.7353
5	40.1004
6	40.2019
7	39.9116
8	40.1747
9	40.7632
10	40.5481
11	42.1173
12	42.1551

Measuring Multiple Timepoints

This can easily be plotted as a chart by clicking on the Chart tab.

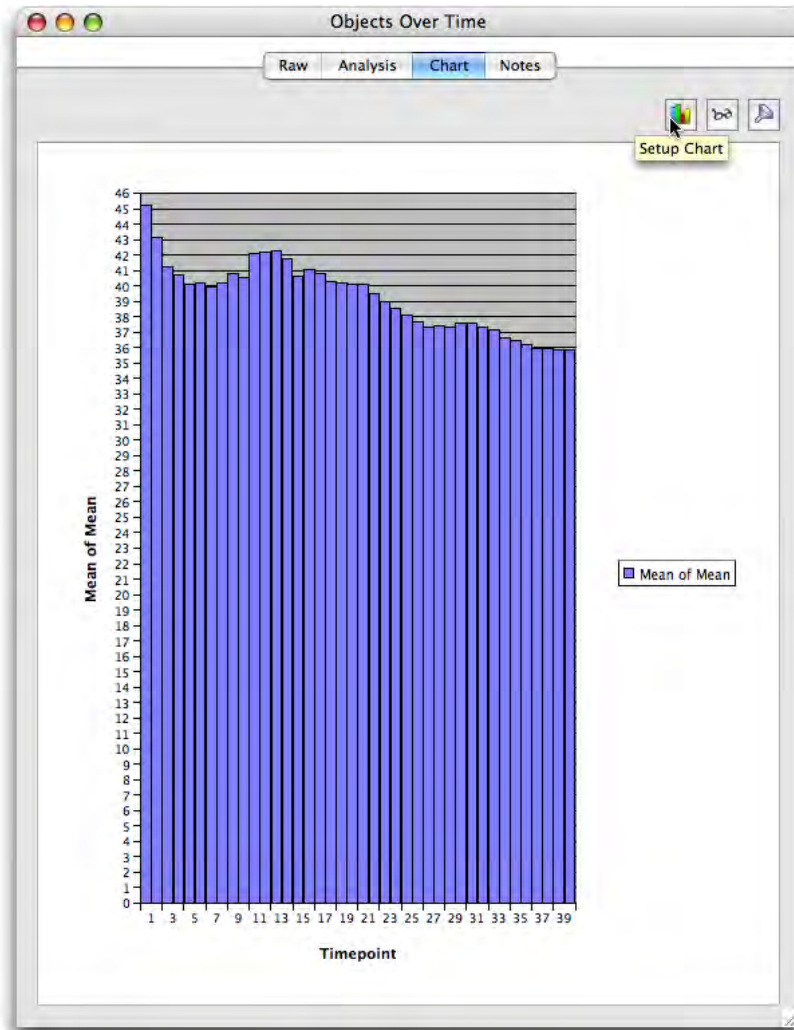

There are many different chart types and options to configure the appearance of the chart, accessed by clicking on the Chart Setup button or selecting **Edit Chart...** from the Chart menu.

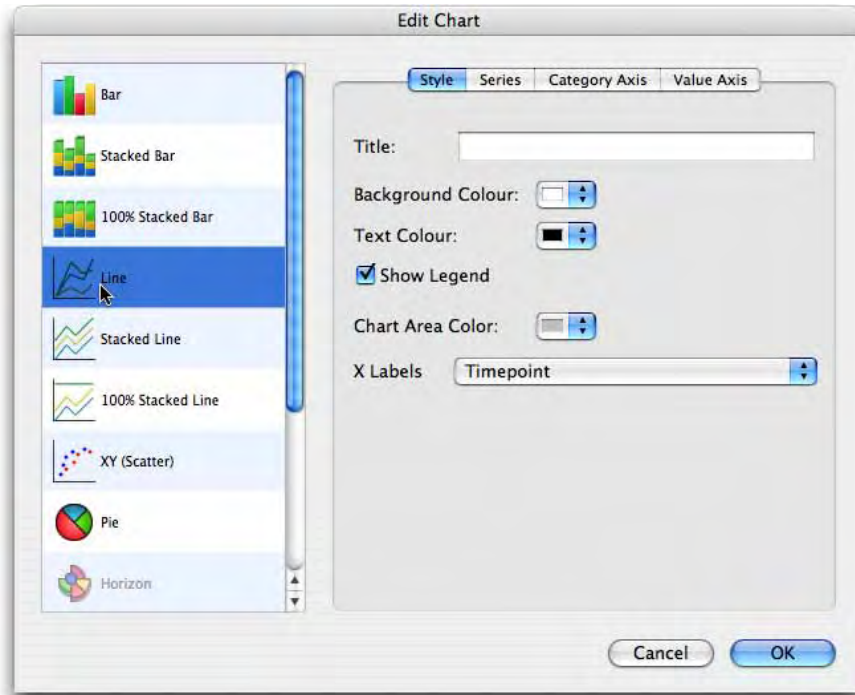

Measuring Multiple Image Sequences

Volocity supports batch processing of image sequences. One Measurements protocol is applied to multiple selected sequences and the results are collected in a single Measurements item.

The process has four stages:

- n Create a protocol to locate objects of interest in your data set. A protocol is used to threshold data to select areas of interest and, from that selection, include or exclude objects based on a range of criteria.
- n Save the protocol.
- n Apply the saved protocol to selected image sequences in the library.
- n Review the results.

If you have a saved Measurements protocol that you would like to apply to multiple image sequences, start at “Apply the Protocol to Selected Sequences” on page 358. Otherwise, you must first create a protocol by opening one of the image sequences that you will measure and viewing the Measurements tab.

To obtain correct values for calibrated spatial measurements, it is important to ensure that the data is calibrated correctly by setting the X, Y and Z pixel dimensions in the Properties dialog, see page 63.

Creating the Measurement Protocol

1. Open the required data set and view the Measurements tab. The Measurements View contains all the tools and information needed for selecting objects.

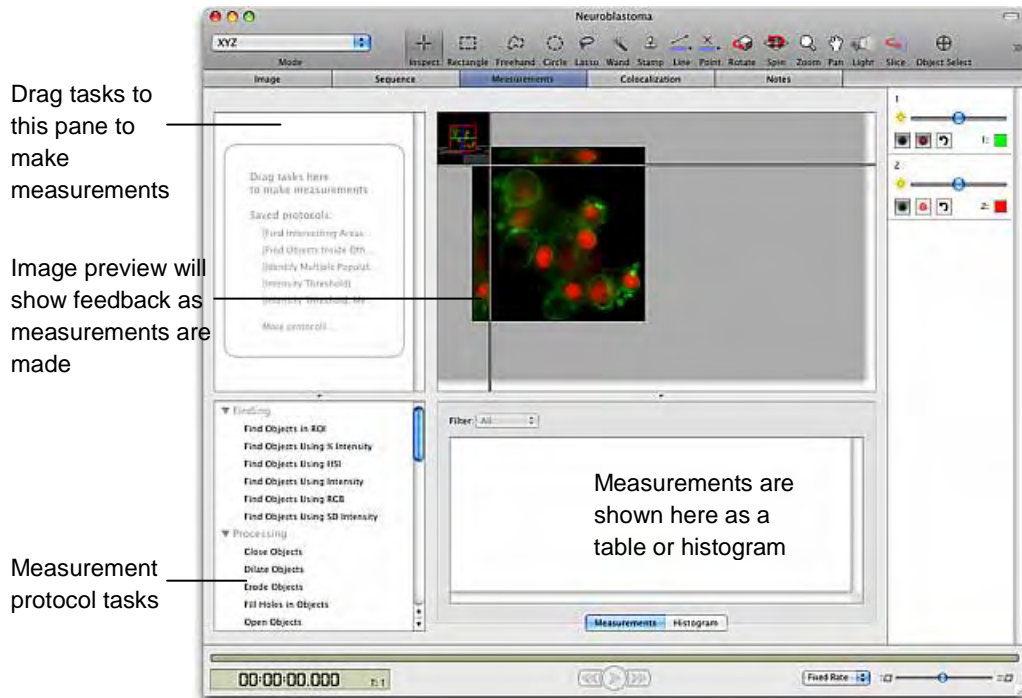

2. Start the protocol by using a Finding task such as **Find Objects by Intensity**. There are other “Find Objects” tasks that may be more appropriate when working with multiple data sets containing images that have widely-varying intensity values (for example, **Find Objects by % Intensity** and **Find Objects by SD Intensity**). These tasks do not use absolute intensity values and are, therefore, better suited to data where the range of intensity values does not remain constant. Descriptions of individual tasks begin on page 400.

If the dataset contains more than one channel, make sure that the channel containing the objects required is selected in the task.



3. The task shows a histogram of the intensity values present within the data set and selected values are shown as a shaded red area on the histogram. Drag the vertical, red lines to adjust the intensity range selected.
4. The selected objects are shown as a colored overlay in the image preview and standard morphological and intensity measurements are displayed in the Measurements table. To change the color of objects found use the **Color Objects** task, see page 419, and to change the measurements made use the **Measure Objects** task, see page 417.
5. If the selected objects are not automatically shown, select **Update Feedback** from the Measurements menu. To update feedback automatically after any change to the protocol, turn on **Automatically Update Feedback** in the Measurements menu.
6. If too many or too few objects have been selected you may need to make adjustments to the protocol.
 - n **Find Objects.** The protocol will only select voxels if they are between the minimum and maximum intensity set in the task. Drag the red bars to include more or fewer voxels. Click on the cog icon in the task panel to access the secondary dialog for the task.



This dialog shows a larger histogram and value entry fields for more precise setting of threshold values. It is also possible to set the thresholds to the maximum and minimum intensity values found within a region of interest drawn on the image. The ROI must be drawn before this dialog is opened. Click **Get From ROI** to populate the settings.

- n **Modify the Selection.** It may be necessary to remove noise from the selection to avoid selecting voxels that are not relevant to the objects required. Add a **Remove Noise From Objects** task to the protocol and select the size of filter to be applied.

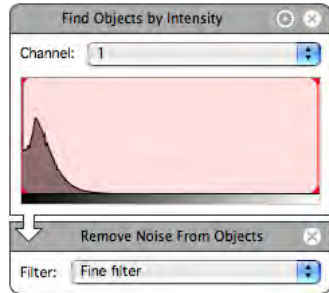

- n **Exclude Objects.** It is also possible to exclude objects based on certain characteristics such as their size, shape or position relative to the edge of the image or an ROI. Use the table of measurements to make decisions about this step. To order the measurements by size to help choose sizes to exclude click on the column heading for Volume (or Area) and the column will be reordered by that value. Add an **Exclude Objects by Size** task to the protocol to exclude objects larger or smaller than the size entered.

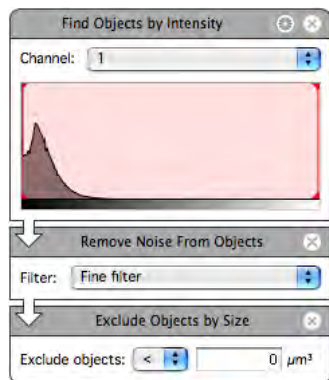

Adjust the protocol, as required, until the preview shows the required selection.

7. Select **Save Protocol...** from the Measurements menu.

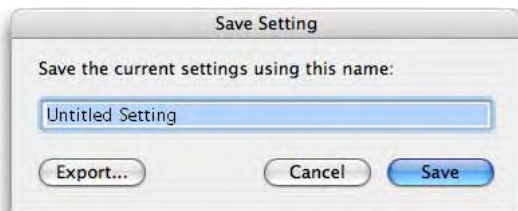

Apply the Protocol to Selected Sequences

1. In the Library View select the items to be batch processed.
2. Select **Measure...** from the Tools menu.

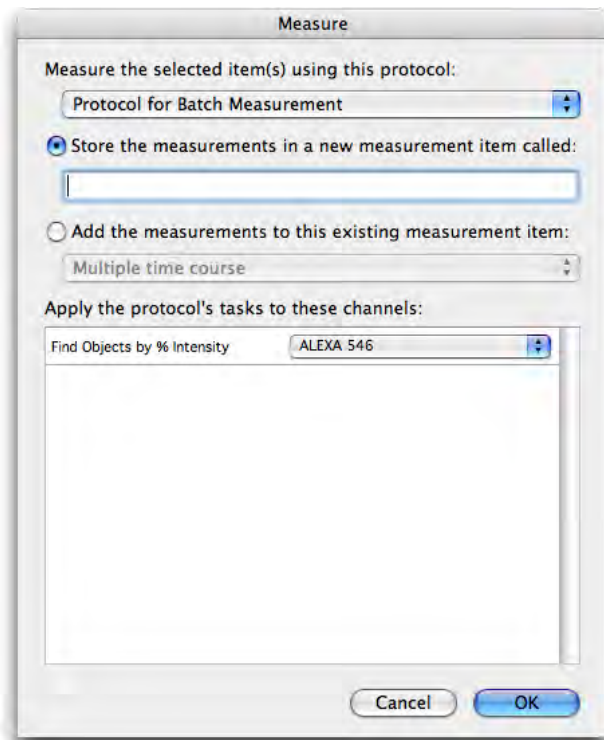

Select the protocol to be applied to the selected items from the drop-down menu, which lists all saved protocols by name.

Either, select **Store the measurements in a new measurement item called:** and enter a name for the Measurement item that will contain all the measurements made by the selected protocol on the selected items. Or, select **Add the measurements to this existing measurement item:** and choose from the measurement items that already exist in the library. In this case, all the measurements from all the selected items will be added to the measurements already in the table.

For each task in the protocol that operates on a specific channel (i.e. the Protocol dialog contains a drop-down for channel selection when the task is configured), there will be an entry under **Apply the protocol's tasks to these channels:** The drop-down lists the unique channel names found within the selected items. Channels with the same name will all be processed.

3. Select the correct channel for each task in the list and click **OK**.

4. A progress bar is shown as each of the selected items is measured with the protocol and the Measurement item is created.
5. Double-click the Measurement item to view the Raw View of all the measured objects.
6. To perform further analysis of this large amount of data, go to the Analysis tab and select **Edit Analysis...** from the Analysis menu.
7. To show the changing mean intensity over time, the Analysis dialog could be configured as shown below:



Organized by: Column: Item Name will organize the data according to the name of the image sequence. Since Item Name is selected for **Column** in the table, these will become individual series in a chart allowing us to visually compare the data sets.

Measuring Multiple Image Sequences

Click on the **Chart** tab to view the chart. The default chart type is a bar chart. Select **Edit Chart...** from the Chart menu to change the chart type. The following example shows a line chart.

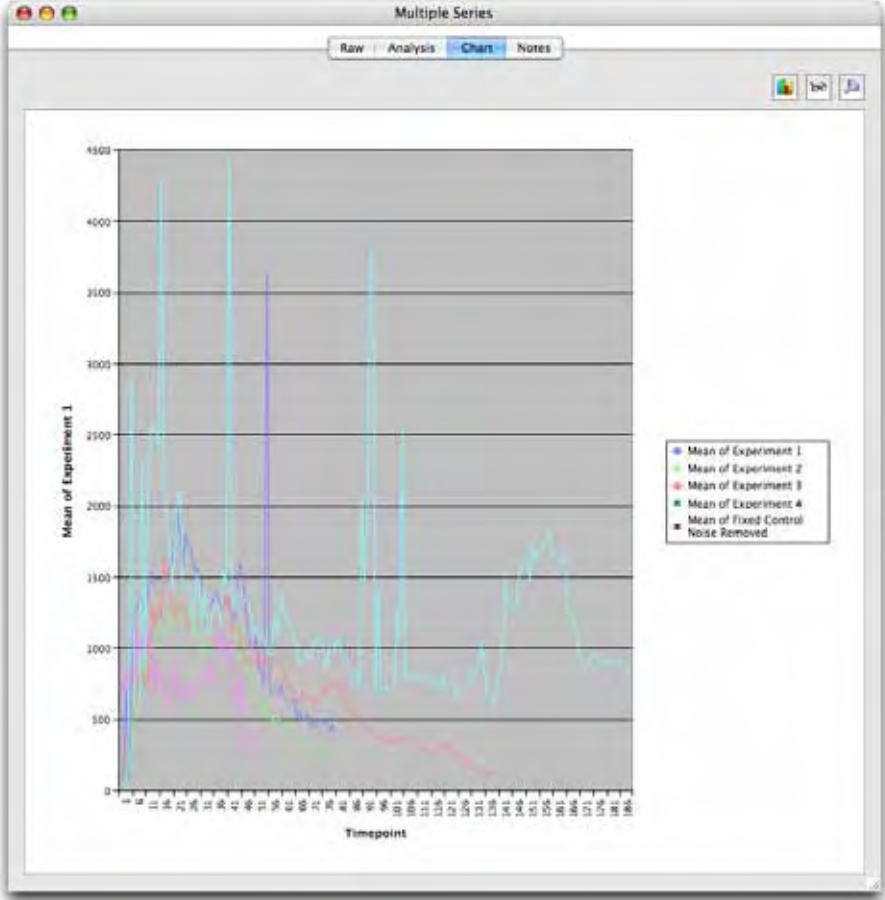

Measuring and Tracking Multiple Timepoints

Velocity's unique time-based measurement architecture allows you to measure and track biological objects as they move in time in both 2D and 3D.

Tracking uses the centroid measurement for each object to identify whether objects have moved between timepoints. It does not use any of the other measurements.

The process has three stages:

- n Create a protocol to locate objects of interest in your data set. This protocol must locate objects as accurately as possible in each timepoint.
- n Measure the objects found by the protocol and generate tracks based on the centroid position of each object.
- n Review the results.

Creating the Measurement Protocol

1. Open the required data set and view the Measurements tab. The Measurements View contains all the tools and information needed for selecting objects.

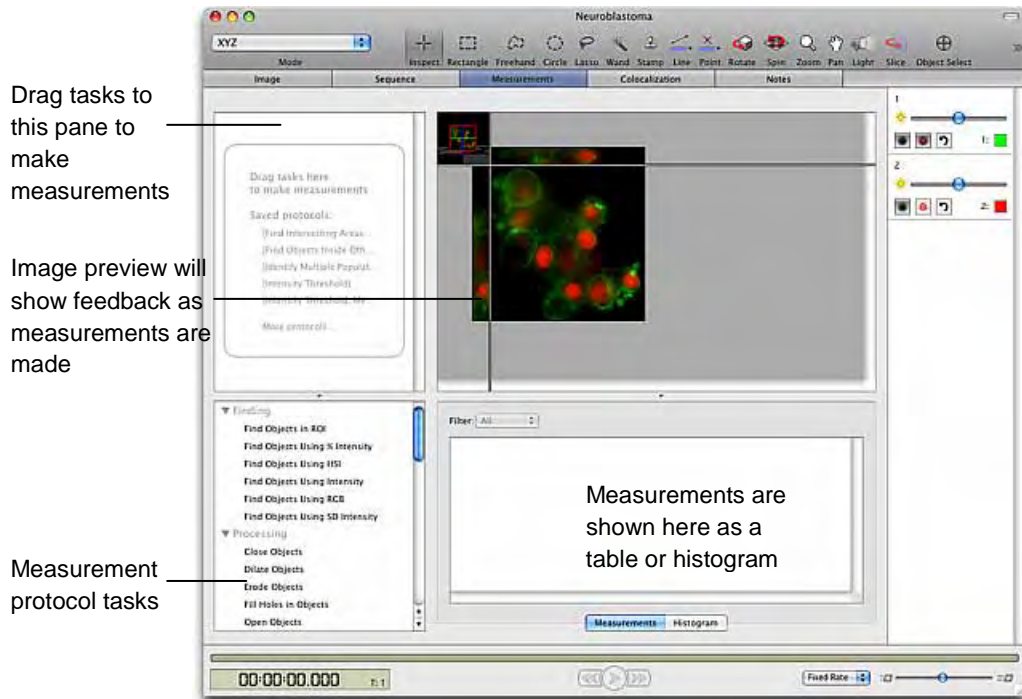

2. Start the protocol by using a “Find Objects” task such as **Find Objects by Intensity**. There are other Finding tasks that may be more appropriate for time resolved data, for example **Find Objects by % Intensity** and **Find Objects by SD Intensity**. These tasks do not use absolute intensity values and are, therefore, better suited to data where the range of intensity values does not remain constant. See the detailed description of individual tasks starting on page 400. If the dataset contains more than one channel make sure the channel containing the objects required is selected in the task.

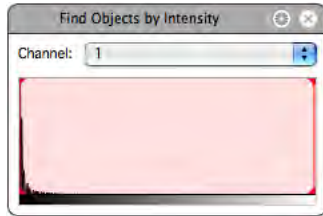

3. The task shows a histogram of the intensity values present within the data set and selected values are shown as a shaded red area on the histogram. Drag the vertical, red lines to adjust the intensity range selected.
4. The selected objects are shown as a colored overlay in the image preview and standard morphological and intensity measurements are displayed in the Measurements table. To change the color of objects found use the **Color Objects** task, see page 419, and to change the measurements made use the **Measure Objects** task, see page 417.
5. If the selected objects are not automatically shown, select **Update Feedback** from the Measurements menu. To update feedback automatically after any change to the protocol, turn on **Automatically Update Feedback** in the Measurements menu.

6. If too many or too few objects have been selected, you may need to make adjustments to the protocol.

- n **Find Objects.** The protocol will only select voxels if they are between the minimum and maximum intensity set in the task. Drag the red bars to include more or fewer voxels. Click on the cog icon on the task in the protocol to access the secondary dialog for the task.

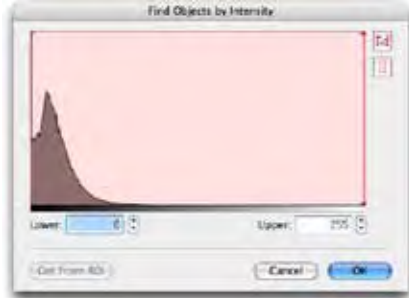

This dialog shows a larger histogram and value entry fields for more precise setting of threshold values. It is also possible to set the thresholds to the maximum and minimum intensity values found within a region of interest drawn on the image. The ROI must be drawn before this dialog is opened. Click **Get From ROI** to populate the fields.

- n **Modify the Selection.** It may be necessary to remove noise from the selection to avoid selecting voxels that are not relevant to the objects required. Add a **Remove Noise From Objects** task to the protocol and select the size of filter to be applied.

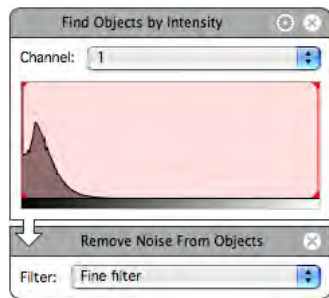

- n **Exclude Objects.** It is also possible to exclude objects based on certain characteristics such as their size, shape or position relative to the edge of the image or an ROI. Use the table of measurements to make decisions about this step. To order the measurements by size to help choose sizes to exclude click on the column heading for Volume (or Area) and the column will be reordered by that value. Add an **Exclude Objects by Size** task to the protocol to exclude objects larger or smaller than the size entered.

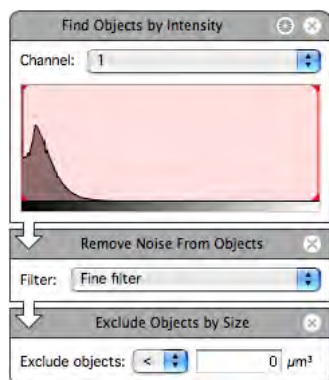

Adjust the protocol, as required, until the preview shows the required selection.

7. You should check the protocol on a number of different timepoints before storing the measurements. This saves time and avoids making unnecessary measurements.

Set up the protocol, then use the Time Navigation controls to move between timepoints. Stop at intervals and **Automatically Update Feedback** will apply the protocol to the new timepoint. If the protocol is not applied when the timepoint changes, select **Update Feedback** from the Measurements menu.

You can then see the effect on the Image View and adjust the protocol for a number of timepoints to obtain the best fit.

Adding a Tracking Task to the Protocol

1. To make the protocol track object centroid position when more than one timepoint is measured, add the **Track Objects** task to the protocol.

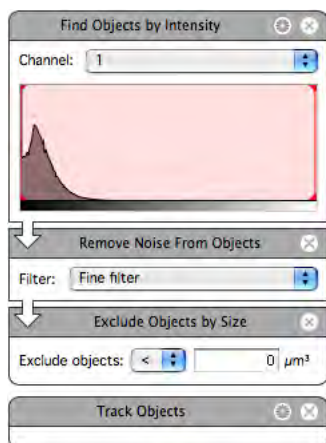

The **Track Objects** task will always go to the bottom of the list of tasks in the protocol. It is not possible to add it between other tasks or to add other tasks after it.

2. Click on the cog icon on the Track Objects task in the protocol pane to access the secondary dialog for the **Track Objects** task.

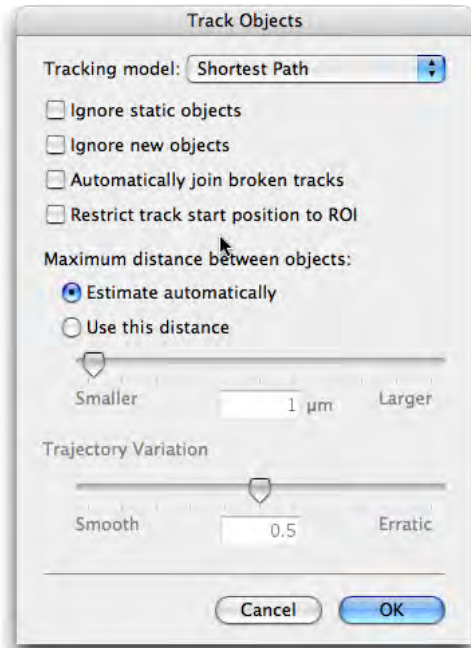

3. Select the appropriate options. These are described fully on page 422. For this example, we will select the **Shortest Path** and allow Volocity to calculate the **Maximum distance between objects** automatically.
4. Click **OK** to close the dialog.
5. Tracking will only be carried out if all timepoints are being measured. Either turn on **Measure All Timepoints** in the Measurements menu to see tracking in the Measurements View, or select **Make a Measurements Item** in the Measurements menu and ensure **Measure: All timepoints** is selected; this makes a Measurements item that contains tracks. New measurement items are added to the bottom of the library.

Measuring and Tracking Multiple Timepoints

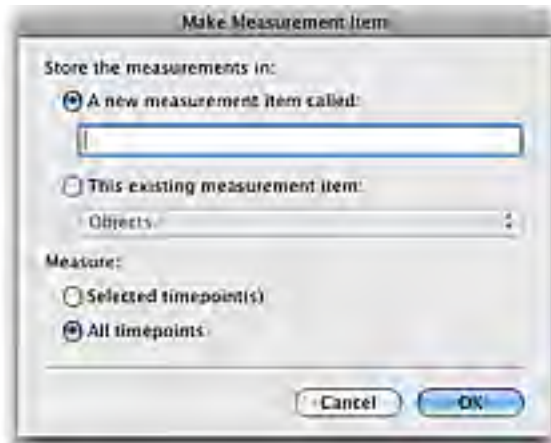

6. When all timepoints are measured Velocity will apply the protocol to all the timepoints and track the centroid positions of the objects found. The Measurements table will show all the objects found in each timepoint and the tracks made from them. Select individual tracks to check and adjust the **Track Objects** task, if necessary.

Viewing the Results

1. Open the Measurement item created by the steps above.

The Raw table shows objects found in each timepoint and the tracks made from them with measurements relevant to each.

Name	Type	ID	Item Name	Volume (µm³)	Timepoint	Abs. Time	Rel. Time	Color	Centroid X	Centroid Y	Centroid Z
Object 7145	Object	7145	vesicle tracking	39	40	17:22:1	8.04958	Blue	68.6923	197.897	68.65
Object 7146	Object	7146	vesicle tracking	40	40	17:22:1	8.04958	Green	38.125	200.975	38.1
Object 7147	Object	7147	vesicle tracking	81	40	17:22:1	8.04958	Blue	44.9138	202.704	44.91
Object 7148	Object	7148	vesicle tracking	103	40	17:22:1	8.04958	Green	47.4	71.0381	4
Object 7149	Object	7149	vesicle tracking	20	40	17:22:1	8.04958	Red	37.7	73.05	3
Object 7150	Object	7150	vesicle tracking	19	40	17:22:1	8.04958	Cyan	34.7895	75.9474	34.78
Object 7151	Object	7151	vesicle tracking	13	40	17:22:1	8.04958	Magenta	113.769	94	113.7
Object 7152	Object	7152	vesicle tracking	23	40	17:22:1	8.04958	Yellow	126.565	118.67	126.5
Object 7153	Object	7153	vesicle tracking	19	40	17:22:1	8.04958	Blue	100.947	191.053	100.9
Object 7154	Object	7154	vesicle tracking	74	40	17:22:1	8.04958	Green	74.6081	202.324	74.60
Object 7155	Object	7155	vesicle tracking	26	40	17:22:1	8.04958	Red	70.3077	201.731	70.30
Object 7156	Object	7156	vesicle tracking	74	40	17:22:1	8.04958	Cyan	60.4054	70.7838	60.40
Object 7157	Object	7157	vesicle tracking	16	40	17:22:1	8.04958	Magenta	75.6875	71.1875	75.68
Object 7158	Object	7158	vesicle tracking	15	40	17:22:1	8.04958	Yellow	117.333	94.2	117.3
Object 7159	Object	7159	vesicle tracking	23	40	17:22:1	8.04958	Blue	91.913	198.913	91.9
Object 7160	Object	7160	vesicle tracking	36	40	17:22:1	8.04958	DarkGreen	80.7778	204.222	80.77
Object 7161	Object	7161	vesicle tracking	4	40	17:22:1	8.04958	Orange	4.25	174.75	4
Object 7162	Object	7162	vesicle tracking	7	40	17:22:1	8.04958	Green	111.143	184.429	111.1
Object 7163	Object	7163	vesicle tracking	13	40	17:22:1	8.04958	Blue	96	198.769	96
Object 7164	Object	7164	vesicle tracking	5	40	17:22:1	8.04958	Green	32.8	200	3
Object 7165	Object	7165	vesicle tracking	4	40	17:22:1	8.04958	Blue	76	67.1	4
Object 7166	Object	7166	vesicle tracking	4	40	17:22:1	8.04958	Green	34.5	69.5	3
Object 7167	Object	7167	vesicle tracking	2	40	17:22:1	8.04958	Red	133	141.5	1
Track 1	Track	7168	vesicle tracking	N/A	N/A	N/A	N/A	Green	N/A	N/A	N/A
Track 2	Track	7169	vesicle tracking	N/A	N/A	N/A	N/A	Blue	N/A	N/A	N/A
Track 3	Track	7170	vesicle tracking	N/A	N/A	N/A	N/A	Green	N/A	N/A	N/A
Track 4	Track	7171	vesicle tracking	N/A	N/A	N/A	N/A	Cyan	N/A	N/A	N/A
Track 5	Track	7172	vesicle tracking	N/A	N/A	N/A	N/A	Blue	N/A	N/A	N/A
Track 6	Track	7173	vesicle tracking	N/A	N/A	N/A	N/A	Green	N/A	N/A	N/A
Track 7	Track	7174	vesicle tracking	N/A	N/A	N/A	N/A	Blue	N/A	N/A	N/A
Track 8	Track	7175	vesicle tracking	N/A	N/A	N/A	N/A	Red	N/A	N/A	N/A

- Choose **Tracks** from the **Filter:** drop-down to quickly view just the tracks.

Objects Time

Raw Analysis Chart Notes

Filter: Tracks Raw data in this measurement item. Showing 102 of 7269 measurements.

Name	Type	ID	Item Name	Color	Track ID	Length	Length (µm)	Time Span	Track Velocity	Track Velocity (µm/s)
Track 72	Track	7239	vesicle tracking	Green	7239	11.6459	11.6459	4	23.5077	23.5077
Track 73	Track	7240	vesicle tracking	Red	7240	8.36278	8.36278	4	16.8806	16.8806
Track 74	Track	7241	vesicle tracking	Blue	7241	10.658	10.658	4	21.5137	21.5137
Track 75	Track	7242	vesicle tracking	Cyan	7242	2.55474	2.55474	3	7.70532	7.70532
Track 76	Track	7243	vesicle tracking	Yellow	7243	5.33353	5.33353	3	16.0864	16.0864
Track 77	Track	7244	vesicle tracking	Purple	7244	3.26082	3.26082	3	9.83494	9.83494
Track 78	Track	7245	vesicle tracking	Orange	7245	6.95341	6.95341	3	20.9721	20.9721
Track 79	Track	7246	vesicle tracking	Light Green	7246	7.3521	7.3521	3	22.1746	22.1746
Track 80	Track	7247	vesicle tracking	Dark Orange	7247	3.23817	3.23817	3	9.76663	9.76663
Track 81	Track	7248	vesicle tracking	Dark Purple	7248	2.32928	2.32928	3	7.02532	7.02532
Track 82	Track	7249	vesicle tracking	Pink	7249	5.74018	5.74018	3	17.5129	17.5129
Track 83	Track	7250	vesicle tracking	Light Purple	7250	7.82853	7.82853	3	23.6116	23.6116
Track 84	Track	7251	vesicle tracking	Cyan	7251	5.03095	5.03095	3	15.1738	15.1738
Track 85	Track	7252	vesicle tracking	Blue	7252	4.09045	4.09045	3	12.3372	12.3372
Track 86	Track	7253	vesicle tracking	Yellow	7253	6.08856	6.08856	3	18.3637	18.3637
Track 87	Track	7254	vesicle tracking	Light Green	7254	1.82811	1.82811	2	10.8781	10.8781
Track 88	Track	7255	vesicle tracking	Orange	7255	2.81611	2.81611	2	16.7571	16.7571
Track 89	Track	7256	vesicle tracking	Blue	7256	2.59864	2.59864	2	15.463	15.463
Track 90	Track	7257	vesicle tracking	Light Green	7257	1.58709	1.58709	2	9.44385	9.44385
Track 91	Track	7258	vesicle tracking	Yellow	7258	4.05281	4.05281	2	24.116	24.116
Track 92	Track	7259	vesicle tracking	Red	7259	2.92866	2.92866	2	17.4268	17.4268
Track 93	Track	7260	vesicle tracking	Pink	7260	1.09511	1.09511	2	6.51635	6.51635
Track 94	Track	7261	vesicle tracking	Light Green	7261	3.03944	3.03944	2	18.086	18.086
Track 95	Track	7262	vesicle tracking	Yellow	7262	1.78098	1.78098	2	10.5976	10.5976
Track 96	Track	7263	vesicle tracking	Light Green	7263	2.00071	2.00071	2	11.9051	11.9051
Track 97	Track	7264	vesicle tracking	Green	7264	2.84422	2.84422	2	16.9243	16.9243
Track 98	Track	7265	vesicle tracking	Pink	7265	3.02813	3.02813	2	18.0187	18.0187
Track 99	Track	7266	vesicle tracking	Light Green	7266	3.56293	3.56293	2	21.201	21.201
Track 100	Track	7267	vesicle tracking	Red	7267	0.781736	0.781736	2	4.65166	4.65166
Track 101	Track	7268	vesicle tracking	Pink	7268	1.08372	1.08372	2	6.44861	6.44861
Track 102	Track	7269	vesicle tracking	Orange	7269	1.27519	1.27519	2	7.58792	7.58792

3. Click directly on the Chart tab to show the tracks as plots of centroid position.

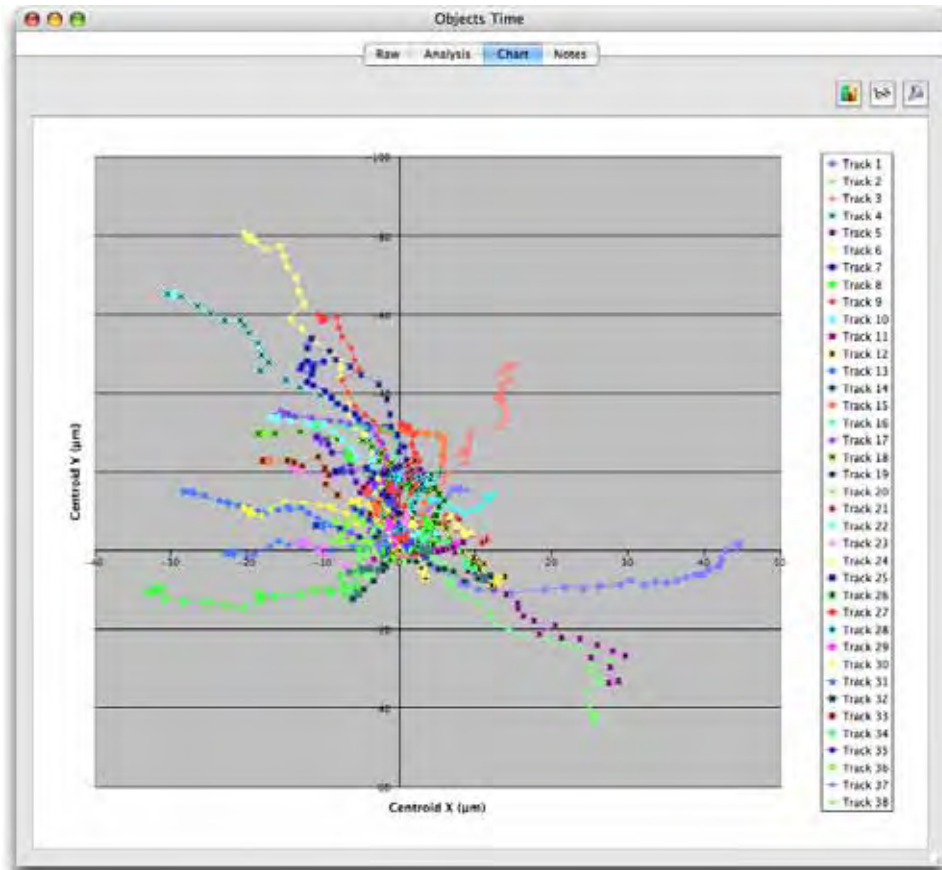

Measuring and Tracking Multiple Timepoints

Select **Edit Chart...** from the Chart menu to change the type of chart and customize many features of its appearance.

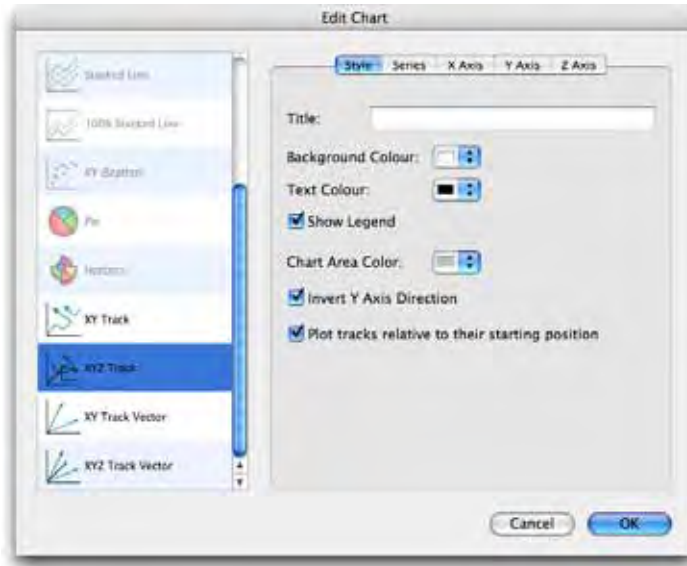

Colocalization

Colocalization is part of the Volocity Quantitation product and is designed specifically for Colocalization analysis as described by Manders et al (1993). See also page 467.

Using the Colocalization View

1. Open the image sequence containing the two channels to be analyzed. The two channels must be the same color depth. It is much easier to visualize colocalization if each channel has a different color. Colocalization does not operate on single volumes.
2. Select the Colocalization tab. Set Channel X and Channel Y using the drop-downs at the top of the screen.

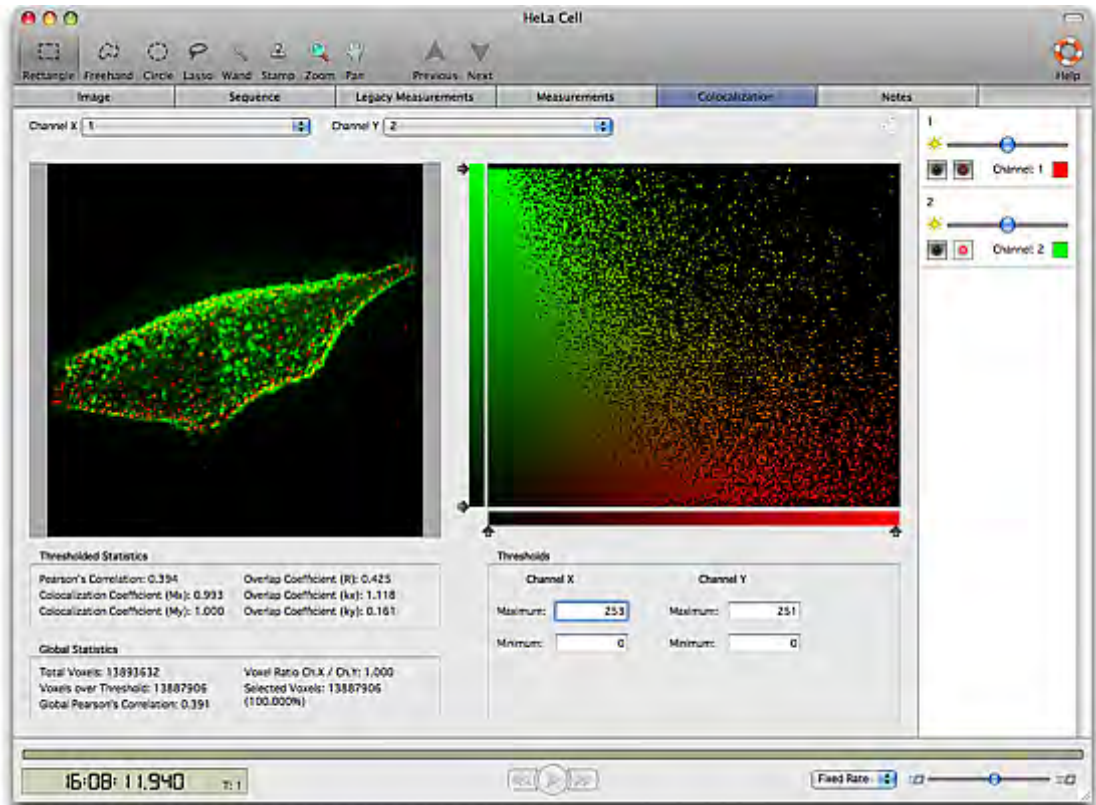

The preview image shows an extended focus merge of the two channels. Volocity calculates statistics and displays them below the preview. Regions of interest can be drawn on the preview. If a region of interest is present on the preview image the statistics will be based on only the voxels within the thresholds within the region of interest. This allows the comparison of statistics generated

from individual cells or structures within the image. If no region of interest is present, the statistics will be based upon voxels within the threshold within the whole image. Working with the scatter plot on the right, set thresholds for each axis so that the lower threshold is above background. It may not be necessary to change the upper threshold.

There are three ways of setting thresholds.

- n Use the ROI tool to draw a region of interest on the Preview. Select **Set Thresholds from ROI** from the Colocalization menu.
- n Enter the required values manually into the Threshold **Maximum** and **Minimum** boxes for each channel or drag the slider controls on the scatter plot.
- n Select **Automatic Thresholding** from the Colocalization menu to generate thresholds automatically.

See page 470 for further information. Any voxels of intensity outside thresholds will be removed from the preview image for that channel. Any point on the scatter plot that is outside thresholds for either channel will be removed from the scatter plot leaving only points that are within the thresholds for both channels. If thresholds are not set, voxels where both images show background intensity levels will contribute to the generation of colocalization statistics, this may make your channels appear to have a better correlation coefficient than is actually the case.

4. Colocalized voxels are shown in an overlay on the preview.
5. You may select regions of interest in the preview. If regions are selected on the preview the statistics and scatter plot will be generated only from the region. If no region is selected the statistics and scatter plot will be based on the whole image.

If required, select sub-regions of the scatter plot for analysis. Use the ROI tools to draw a region of interest on the scatter plot. Voxels selected on the scatter plot will be shown in an overlay on the preview. The preview will update so the overlay shows the location of just the selected voxels. The statistics will also update to reflect the selected voxels. The Edit menu, Select all command will select the whole scatter plot.

6. Create the colocalization output.
Select **Generate Colocalization** from the Colocalization menu and choose the required output.



- n Field statistics are stored within a measurements item in your current library. The field statistics measurements item contains a record of the co-localisation statistics of the voxels included in your analysis. Each time point in your image sequence will have a row devoted to it in the field statistics measurement item.

Color	Pearsons Correlation	Overlap Coefficient R	Overlap Coefficient Kx	Overlap Coefficient Ky	Colocalization Coefficient Mx	Colocalization Coefficient My	X Min Threshold	X Max Threshold	Y Min Th	Y Max Th
0	0.430517	0.50151	0.219467	1.15517	0.396597	0.906645	19	247	26	
7	0.417562	0.483643	0.189865	1.23199	0.359811	0.905863	19	247	26	
1	0.440786	0.500728	0.227316	1.10299	0.39071	0.89598	19	247	26	
7	0.429936	0.489679	0.211511	1.22306	0.36231	0.887072	19	247	26	
4	0.448082	0.506791	0.236073	1.11633	0.387571	0.860741	19	247	26	
1	0.453002	0.511226	0.218137	1.29811	0.389546	0.872362	19	247	26	
2	0.456174	0.510356	0.202454	1.28653	0.371457	0.877727	19	247	26	
4	0.449348	0.501382	0.192202	1.31476	0.351907	0.877458	19	247	26	
4	0.438415	0.489552	0.176284	1.36174	0.333893	0.874128	19	247	26	
3	0.435496	0.486102	0.165416	1.42849	0.331866	0.875127	19	247	26	
5	0.437606	0.488937	0.161562	1.47967	0.335657	0.866873	19	247	26	
3	0.439584	0.496618	0.180173	1.38885	0.36407	0.852617	19	247	26	
5	0.41943	0.478625	0.161371	1.41596	0.340119	0.848131	19	247	26	
1	0.399001	0.459853	0.145892	1.46946	0.31789	0.842481	19	247	26	
7	0.375746	0.436899	0.131711	1.4488	0.291314	0.83208	19	247	26	
2	0.362482	0.421965	0.120168	1.48171	0.274988	0.826485	19	247	26	
5	0.346523	0.403915	0.109525	1.48959	0.257281	0.814727	19	247	26	
4	0.322106	0.379431	0.099511	1.44676	0.230691	0.79946	19	247	26	
4	0.301378	0.359152	0.0918498	1.40436	0.209422	0.788091	19	247	26	
1	0.283718	0.341536	0.0842443	1.38463	0.196631	0.772749	19	247	26	
2	0.267795	0.325856	0.0764807	1.38835	0.181666	0.760746	19	247	26	
7	0.258888	0.314508	0.0724557	1.36518	0.173576	0.753033	19	247	26	
8	0.245045	0.303396	0.0678214	1.35715	0.163145	0.745095	19	247	26	
3	0.226274	0.285199	0.0619751	1.31244	0.152125	0.733723	19	247	26	
9	0.209729	0.269312	0.0562239	1.29	0.142805	0.729942	19	247	26	
9	0.19619	0.256723	0.0518744	1.2542	0.134437	0.722068	19	247	26	
3	0.185512	0.247393	0.048844	1.25303	0.127284	0.712652	19	247	26	
3	0.167702	0.22992	0.044259	1.19441	0.114823	0.70134	19	247	26	
5	0.154219	0.217196	0.0404929	1.165	0.105762	0.6898	19	247	26	
1	0.148908	0.211475	0.0385251	1.16085	0.100718	0.683035	19	247	26	

- n The scatter plots are saved to a folder in the current library. Each scatter plot is stored as a 2D image and may be exported.

Colocalization

- n If any voxels were selected in the scatter plot they are displayed in the Colocalization channel. These voxels are marked in the Colocalization View preview with the colored overlay. The channel is produced from a brightest point merge honoring the color and intensity of those voxels in the original channels.

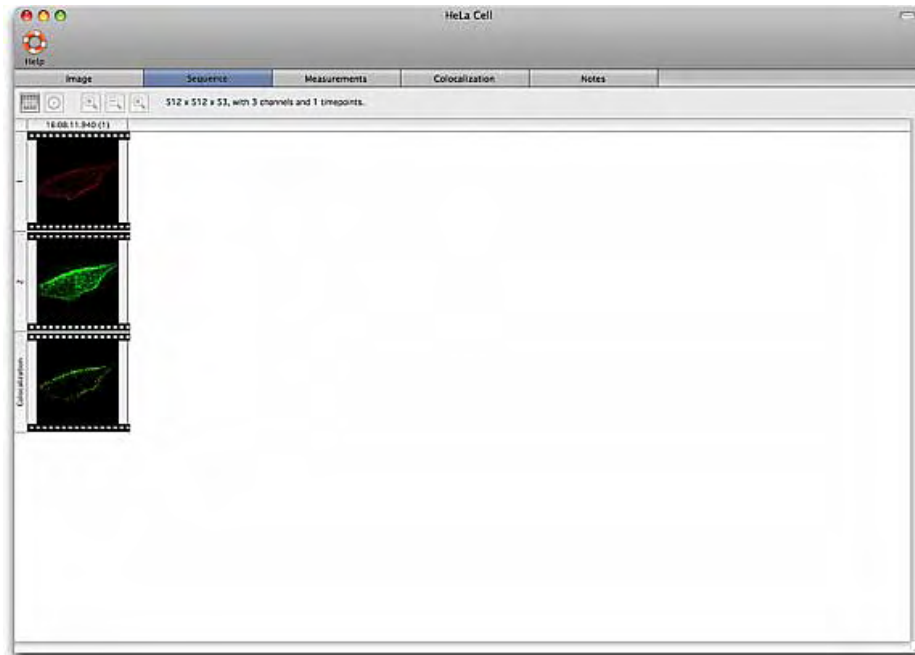

- n A merged channel is made by generating a color channel with contributions from each of your analyzed channels. Merged channels such as this are often used for simple red plus green gives yellow (in areas on colocalization) visual analysis of colocalization. We recommend that you only use this channel for simple visual illustration purposes.

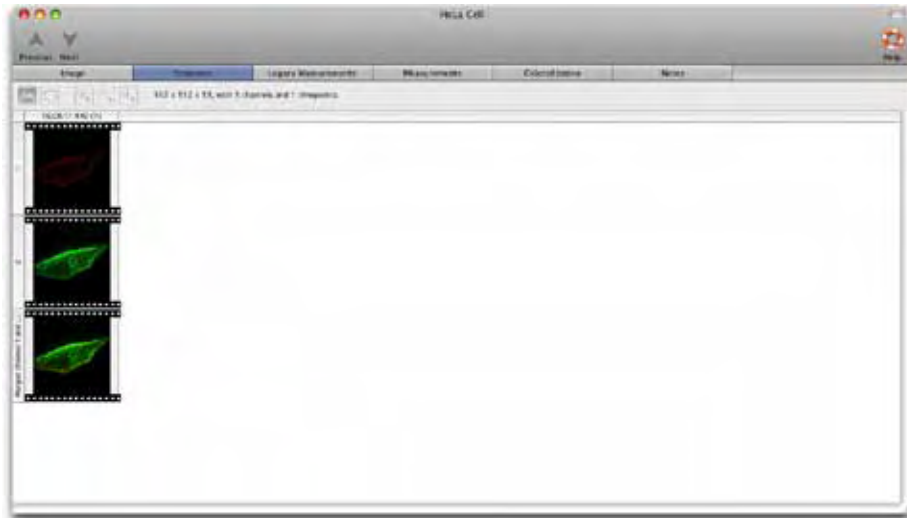

- n PDM channels are generated by calculating the product of the difference from the mean for each voxel from the two channels analyzed.

Velocity generates two PDM channels, a positive channel which is colored yellow, and a negative channel which is colored purple.



Volocity Quantitation Reference

Overview

This is the reference chapter for Volocity Quantitation. For worked, step-by-step examples on measuring and analyzing data at a single timepoint and at multiple timepoints, please see page 173.

This chapter describes:

- n The Measurements View
- n How to draw points, lines and ROIs to create objects manually
- n How to create measurement protocols and use them to select objects
- n Raw Data, Analysis and Chart Views
- n How to visualize and quantify colocalization between pairs of images
- n FRAP and FLIP analysis
- n Ratioing
- n FRET analysis

Measurements View

To measure objects, they must first be identified. The Measurements View provides all the tools required to identify objects and make a variety of measurements from those objects. Use the Region of Interest drawing tools to manually draw around objects (see page 378), or automatically detect objects by creating a measurement protocol using the Measurement Protocol tasks (see page 396).

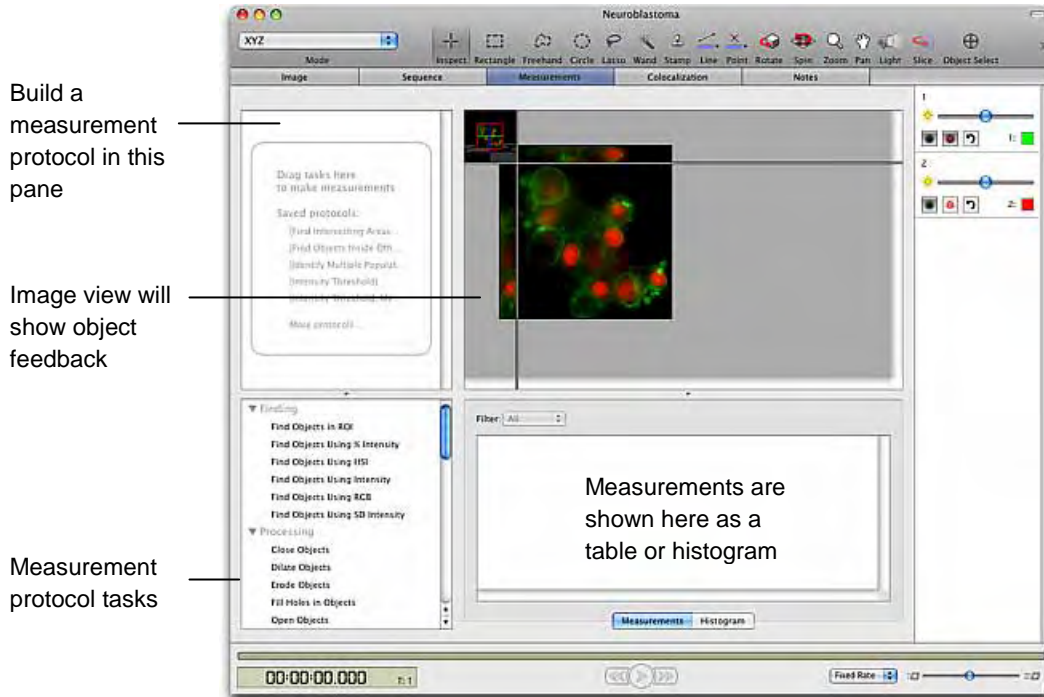

Image View

This is an Image view within the Measurements view. Image view mode may be changed to the option most useful when selecting objects using the popup. Options for showing overlays and additional information in the Measurements menu allow you to configure this view in the same way as you would configure the Image View, see page 85.

Measurements and Histogram

The Measurements table provides numerical information about the objects found in the image directly above it. This numerical information is only shown for objects are selected in the image either by a user-drawn ROI or a measurements protocol.

Click on the **Histogram** tab to display the numerical information as a simple histogram, one column from the table at a time. Use the histogram to find patterns in a selected item property.

Choose the data to be shown from the drop-down list of those available.

Using the Drawing Tools

Drawing Lines with the Line Tool

Lines are used to measure distances for example between two structures or along the length of a boundary.



Use the Line tool to add lines in the Image View. Connect two or more points by holding down the Shift key and clicking with the cursor. Release the Shift key to end a line.

The total length of the line and an intensity profile are displayed as the line is drawn. Turn off this display in the **View Options...** dialog found in the Measurements menu.

Once drawn, you can move the points along lines. To do this the line tool must be selected and the cursor moved over the lines. The cursor changes shape over a control point indicating that you can grab and move it.

To delete part of a line double click on a control point to highlight that section of the line and use the Backspace (Mac) or Delete (WINDOWS) key. To delete all the lines active on the view, use the **Select None** command in the Edit menu.

As lines are drawn automatic feedback updates the table below the image to show the measured lengths. For each line a row is shown in the table below the image preview. The length of the line is shown uncalibrated and as calibrated units.

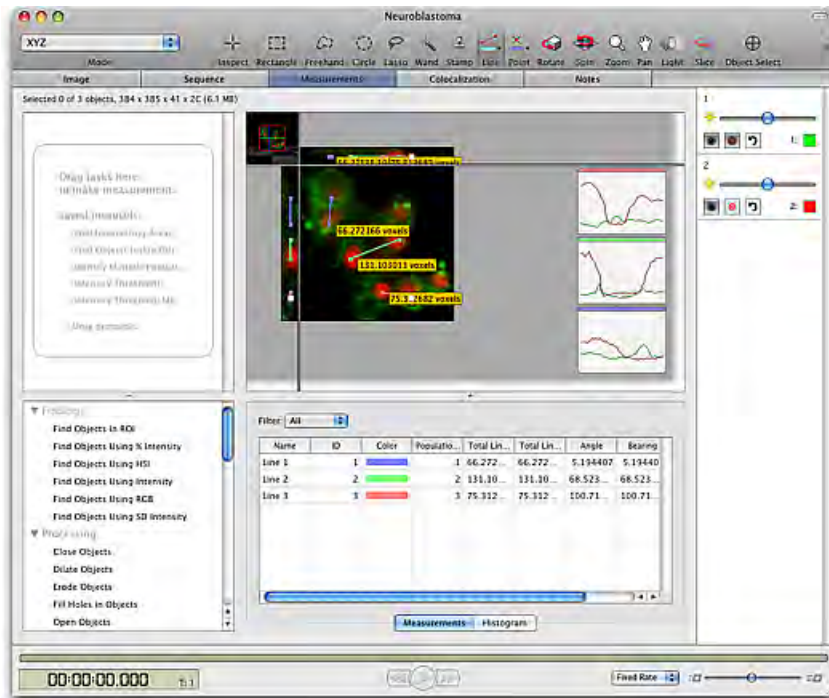

When working with 3D data the XYZ mode of the image will allow accurate positioning of the points joined by the line. Use any part of the view to mark and reposition points.

Line measurements are also shown in the table below the Image View. Export this table as a text file by selecting **Export...** from the File menu and selecting one of the options for exporting the view rather than the item. Save this table in the library by selecting **Make Measurement Item...** from the Measurements menu.

Setting Up the Line Tool

Velocity will automatically assign a different color for each line or you can specify a color. Next to the Line tool in the tool bar is an arrow. Click here to display the color picker dialog. Choose one of the displayed colors or specify a color. Choose **Automatic** to return to colors assigned by Velocity. Note how the line tool reflects the color selected.

Point Counting with the Point Tool

Use the Point tool to count objects in the image. Select the Point tool and click on objects of interest in the image. For each click a point is marked on the image. These points are numbered and the numbering increases by one with each click.

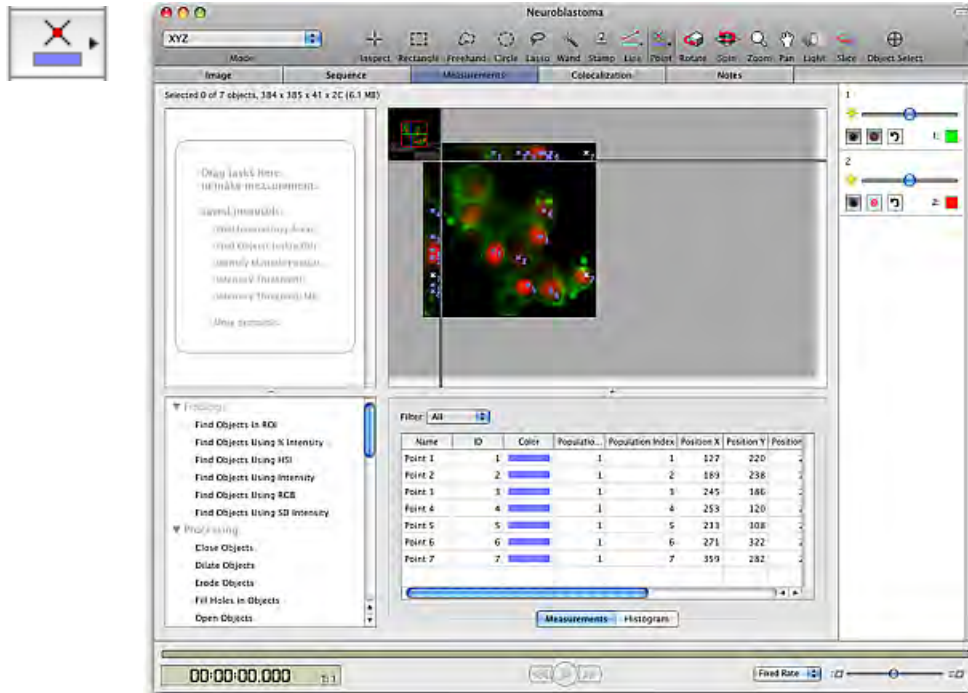

Count two populations of objects in the same image using the color of the points. Specify a new color and therefore new population. Next to the Point tool in the tool bar is an arrow. Click here to display the color picker dialog. Choose one of the displayed colors or specify a color. Choose **Automatic** to return to colors assigned by Velocity. A new color will start a new count at one.

To delete a point, click on it to highlight it and use the Backspace (Mac) or Delete (Windows) keys. Other points of the same color will be renumbered. To clear all points on the screen go to Edit menu, Select None.

For each point, a row is shown in the table below the image preview. The position of the point as X, Y and Z coordinates is stored. All points of the same color are assigned the same population ID.

- n Export this table as a text file by selecting **Export...** from the File menu.
- n Save this table as an item in the library by selecting **Make Measurement Item...** from the Measurements menu.

Drawing Regions Using ROI Tools

Use these tools to draw a region of interest. The selected area will be outlined with "marching ants", a moving outline. Each object (i.e. contiguous block of voxels) within the ROI will be assigned a different color. Regions of interest are shown in the Image View using a colored overlay. Select **View Options...** from the Measurements menu to change this.

For each object a row is shown in the table below the image preview. Some default morphological and intensity information for each object is stored.

- n Export this table as a text file by selecting **Export...** from the File menu.
- n Save this table as an item in the library by selecting **Make Measurement Item...** from the Measurements menu.



The Rectangular ROI selection tool allows you to draw rectangles or squares.

Shortcut key R



The Freehand tool allows you to make a freehand selection of an area on the image.

Shortcut key F



The Lasso tool allows you to trace the outline of a selection. It selects regions based upon the color similarities of adjacent pixels. The initial point clicked sets the color to compare and the tool has the effect of shrinking around the pixels that fall outside of the tolerance value.

Shortcut key S

Setting Up the Lasso Tool

Double-click on the Lasso Tool in the tool bar to display a dialog in which you may adjust the Tolerance of the selection.

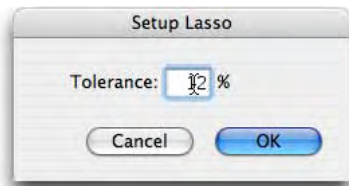

Shortcut key W

The Magic Wand tool has the effect of expanding the selection outwards from the original pixel clicked on until the threshold set by the Setup Magic Wand is reached.

Setting Up the Magic Wand

Double click on the Magic Wand tool to display the Setup dialog.

click to select only contiguous voxels, or all groups that meet criteria

click to select one of the threshold criteria

if required, check to enable filter

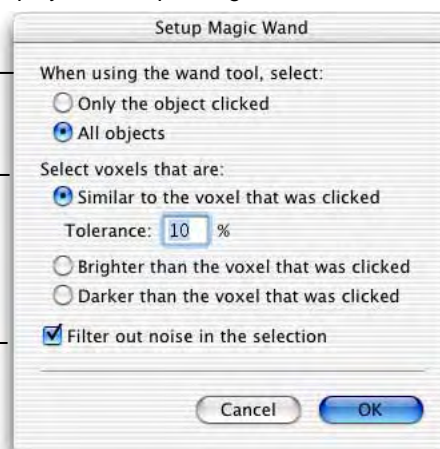

Note: If you are trying to isolate regions of interest from background data, it may be easier to use the Wand tool to select the background, use the **All objects** criterion and then apply the **Reverse Selection** command in the Actions menu.

Filter out noise in the selection will apply a 3x3x3 median filter. This will remove very small objects that are often described as noise and can add significantly to the time taken to make the measurement.



The ROI stamp tool makes a selection by placing an ROI of a predetermined shape and size on the image, centered on the cursor position. This is useful for making ROIs of a known size and/or repeating a selection of a known size.

Setting up the ROI Stamp Tool

Double click on the ROI Stamp Tool to display the Setup dialog.

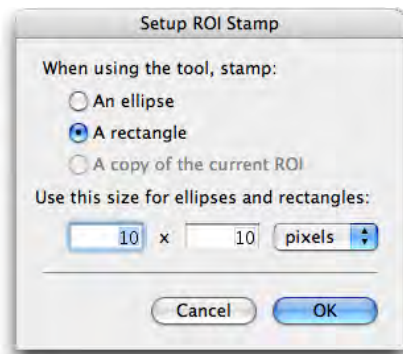

The size of the ROI may be set in pixels or micrometers. An ROI size set by micrometers will vary in the number of pixels depending on the calibration of the item.

Target Channel

The Magic Wand and Lasso tools work on voxel intensity. So, within multi-channel data sets in an image sequence, the size and shape of the selection made by the tool can be very different depending on which channel is targeted when the selection is drawn. Use the target channel button in the channel controls to choose the channel on which the selections will be made. See page 82 for more information about working with Channel Controls.

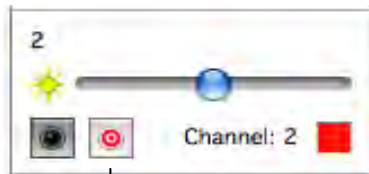

Target channel button

Using the Drawing Tools

The following example shows the selection made if the magic wand is clicked when the red channel is targeted.

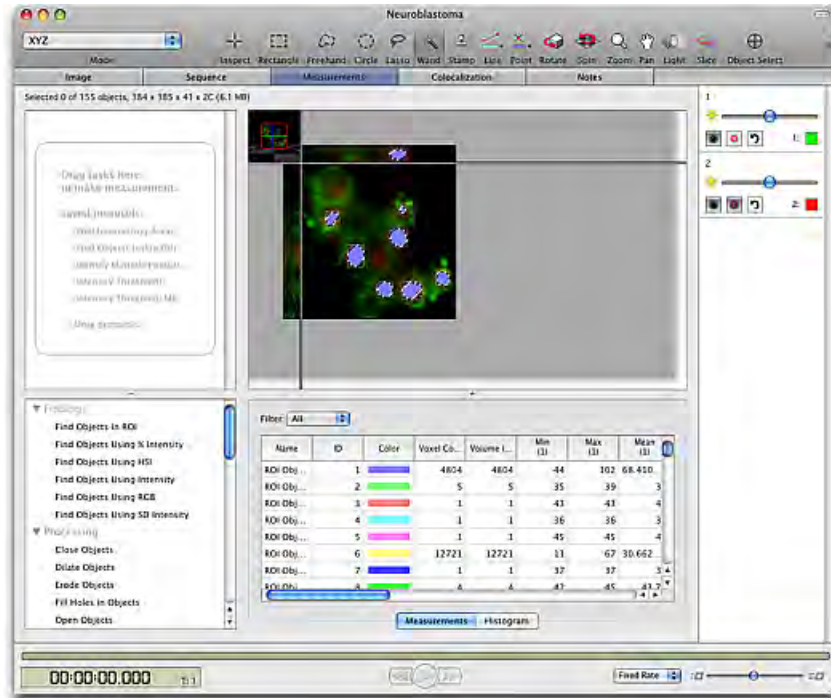

Single plane reference images can not be made the target for selection.

In the following example the magic wand is clicked at the same location, but the selection is different because the green channel is now targeted.

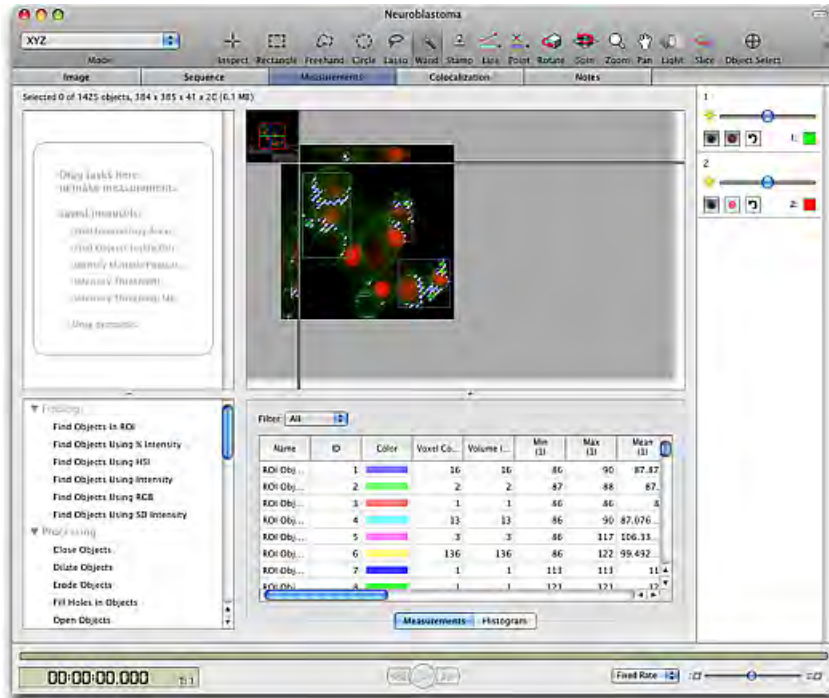

Working with Regions

Once you have created a region of interest (ROI), there are a number of options available.

Crop to Selection

From the Actions menu select Crop to Selection to create a new image sequence at the dimensions of the ROI. Hold down Ctrl key (Windows) or Alt key (Mac OS) to crop to selection in place, without creating a new image sequence.

ROI menu

The sub-menu **ROI** under the **Edit** menu contains commands for working with ROIs once they have been drawn.

- n **Undo** to undo the last change made to an ROI
- n **Redo** to redo the last change made to an ROI
- n **Save** to store the currently active ROI as a settings file in the preferences
- n **Restore** to recall a previous stored ROI and apply it to the current view
- n **Grow** to expand the ROI by one voxel in all directions
- n **Shrink** to reduce the ROI by one voxel in all directions

Key combinations

The following key combinations also apply:

Mac OS key combinations

- n Control-drag on a selection centers the selection on the image.
- n Command-drag locks the dimensions, to make a square or circular selection rather than rectangular or oval.
- n Shift allows you to add to the ROI or draw multiple ROIs.
- n Shift + alt (option) allows you to subtract from the ROI or subtract the whole of the existing ROI by drawing around it.
- n Alt (option) carries out an AND operation leaving only the intersection of the two ROIs. This allows you to select in one part of the XYZ view and refine the selection based on what can be seen in another part.

Windows key combinations

- n Shift allows you to add to the ROI or draw multiple ROIs.
- n Shift + ctrl allows you to subtract from the ROI or subtract the whole of the existing ROI by drawing around it.
- n Ctrl carries out an AND operation leaving only the intersection of the two ROIs. This allows you to select in one part of the XYZ view and refine the selection based on what can be seen in another part.

Kymograph

A kymograph is created from a multi-timepoint image sequence and is a method of displaying time dependent events. In a kymograph image one axis represents distance along a line and the other time.

Use the Line tool, in any view that it is available, to specify the distance axis. The start point of the line is considered the origin of the distance axis. On 3D data check and adjust the position of the line using the XYZ mode. Movement along or across this line will be recorded in the kymograph. A kymograph image will be generated for each line drawn.

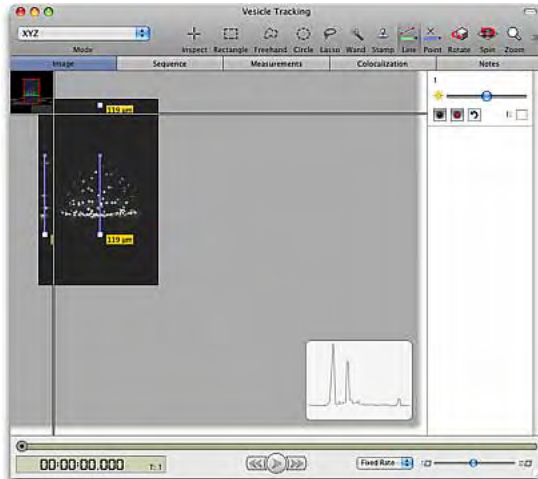

Select **Kymograph...** from the Tools menu.

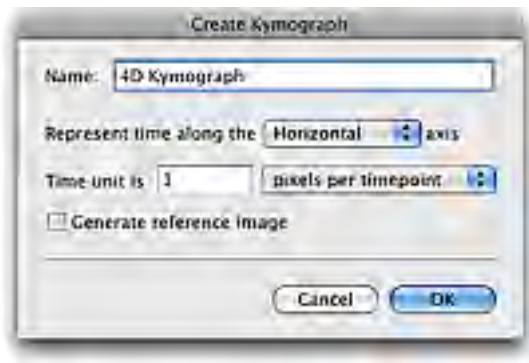

The intensity under the line will be sampled at intervals (at the smallest resolution out of the X,Y and Z axes) to form the distance axis of the kymograph, the corresponding positions in all timepoints will be sampled to form the other axis.

Kymograph

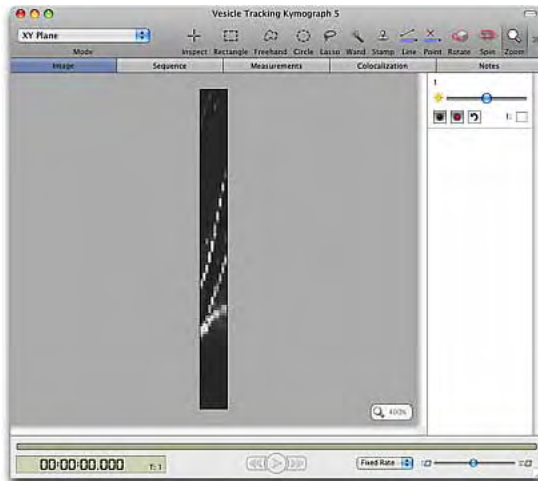

A kymograph created from multi-channel data will be a multi-channel sequence, the display of channels in a kymograph may therefore be controlled using the channel controls. 2D reference channels in 3D sequences will be ignored and will therefore not appear in the kymograph image.

The reference image is a snapshot of the image data with the line(s) visible to record where they were drawn. Kymograph images are not calibrated, calibrated measurements cannot automatically be made from kymographs in Velocity.

Object Feedback

As objects are selected in the image, feedback is shown both in the image preview and in the measurements table below the image. You can relate measurement rows to objects shown in the image.

- n To show which object in the image is represented by a row in the table, select the row. Visual feedback for all other objects will be hidden, leaving just the selected object shown. Go to the Edit menu and Select None to clear this individual feedback.

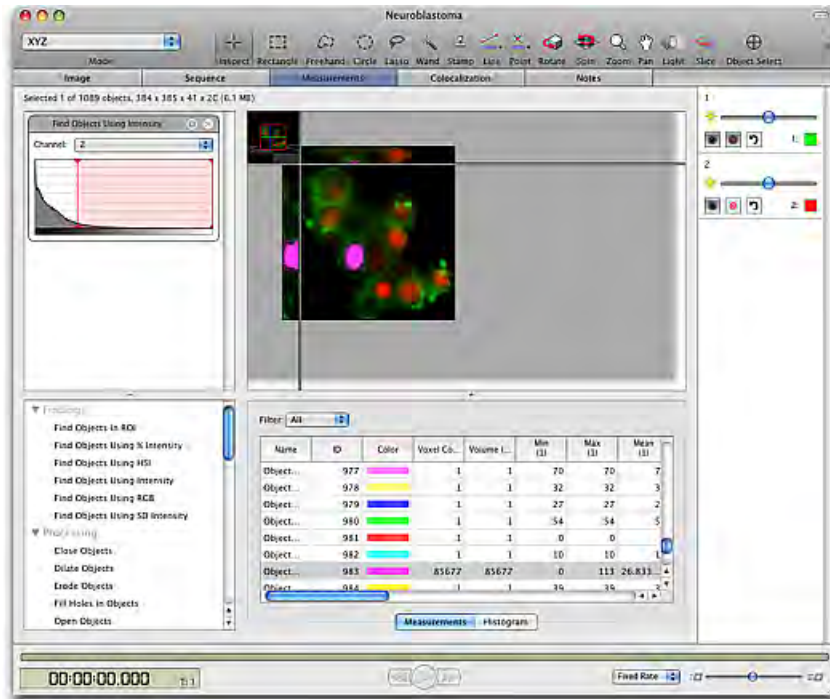

Object Feedback

- n To find measurements for objects use the Select object tool from the tool bar. The cursor changes to a pointing hand when it is over voxels which have been measured as part of an object, click to select the object, and the relevant row will be highlighted in the table.

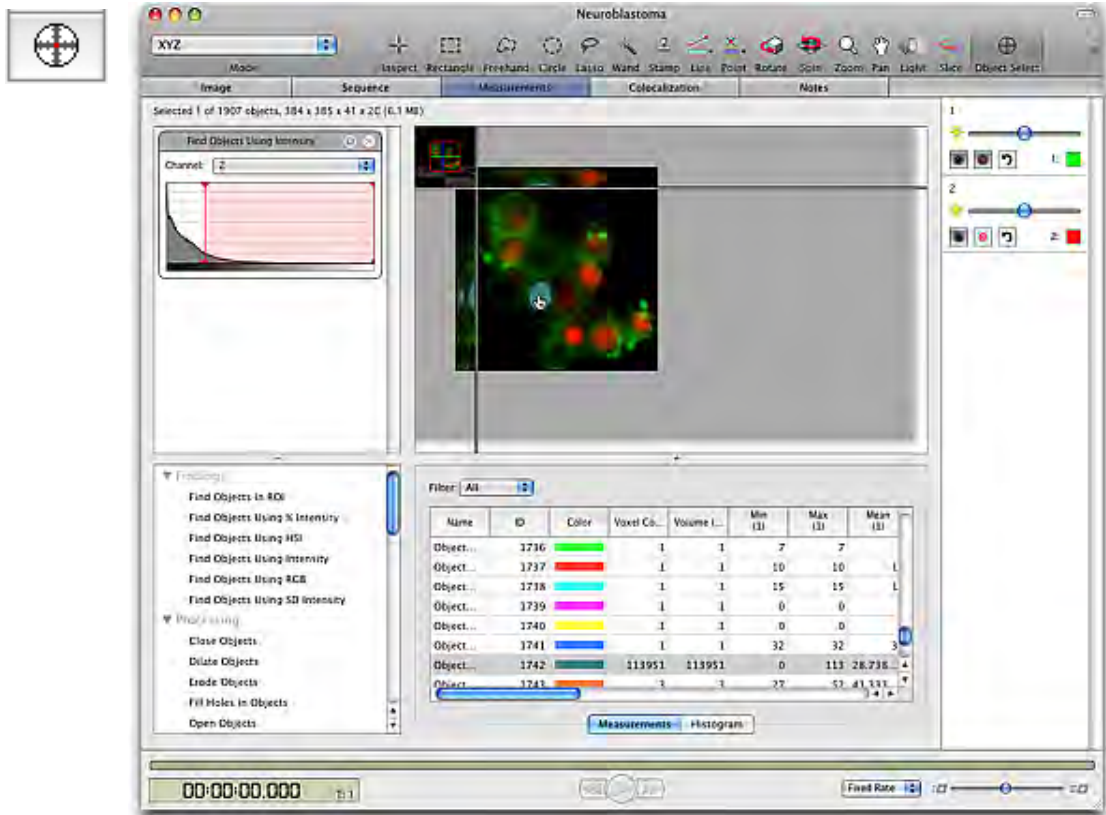

The screenshot displays the Neuroblastoma software interface. The main window shows a 3D visualization of objects with a mouse cursor pointing at one of them. The interface includes a toolbar at the top with various tools like 'Inspect', 'Rectangle', 'Freehand', etc. Below the toolbar are tabs for 'Image', 'Sequence', 'Measurements', 'Colocalization', and 'Notes'. The 'Measurements' tab is active, showing a table of object data. The table has columns for Name, ID, Color, Voxel Co., Volume L., Min (L), Max (L), and Mean (L). The row for Object 1741 is highlighted in blue. To the left of the main window, there is a 'Find Objects Using Intensity' panel with a histogram and a 'Processing' panel with various object manipulation options like 'Close Objects', 'Dilate Objects', etc. The bottom status bar shows a timer at 00:00:00.000 and a 'Final Rate' indicator.

Name	ID	Color	Voxel Co.	Volume L.	Min (L)	Max (L)	Mean (L)
Object...	1716	Green	1	1	7	7	
Object...	1737	Red	1	1	10	10	L
Object...	1718	Cyan	1	1	15	15	L
Object...	1739	Magenta	1	1	0	0	
Object...	1740	Yellow	1	1	0	0	
Object...	1741	Blue	1	1	32	32	3
Object...	1742	Dark Green	113951	113951	0	113	28.738
Object...	1743	Orange	1	1	27	57	41.531

Measurements Menu

Many of the options in the Measurements menu are identical to those in the Image View (see page 90). These allow you to configure the image to assist in object selection. You can change how the image is displayed with the Mode option.



The rest of this section describes those menu options that are specific to measurement.

Measurements Feedback Options

In the Measurements View the location of objects selected in the image is shown using feedback. The updating of feedback is set by the **Automatically Update Feedback** option in the Measurements menu. The visual appearance of the feedback is controlled by the **Feedback Options...** in the same Measurements menu.

Change the feedback options to show feedback and images more clearly together and to illustrate specific points.

The Feedback Options dialog is divided into tabs, one for each type of measured item that could be shown and the changes that can be made to their display.

You may choose to show each type of feedback or not, and there are sub options within each tab.



- n **Show in current timepoint only** is an option for viewing feedback within time resolved data. When this option is checked only feedback that relates to measurements made from the current timepoint will be shown. Changing the timepoint using the time navigation will change the feedback so that only objects in the new timepoint are shown.
- n **Show measurement** will allow any of the measured parameters to be shown alongside colored overlay which represents the measured object.

To change the appearance of an ROI that is drawn on a view use the ROI tab in the View Options dialog for that view.

Measurement View Options

Change aspects of the view display using the **View Options** dialog.

The dialog is divided into tabs for the different features that can be displayed.



In the General tab line length and line profile refer to what is to be displayed if a line tool is used to draw a line on the screen. The floor settings refer to a floor which is shown in some of the views.

The ROI tab shows setting applicable to regions of interest drawn on the Measurements view. To change how objects selected by a measurements protocol are displayed in the view, use the **Feedback Options** dialog also available from the **Measurements** menu.

Make Measurement Item

Go to the Measurements menu and select **Make Measurement Item...** to create a new table item in the library containing the measurement rows as previewed in the Measurements View.

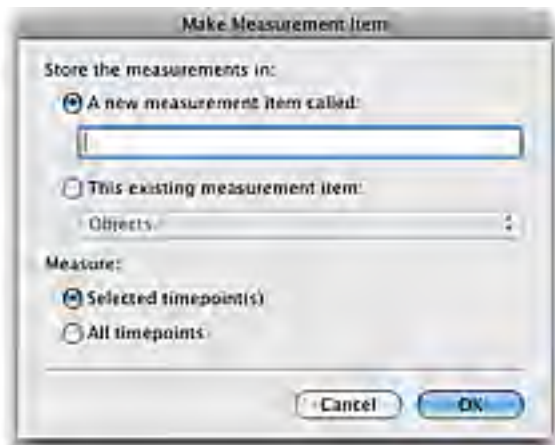

A new measurement item may be created and named or the measurements may be added to an existing measurement item to build up a table of data.

For time-resolved data you may select measure all timepoints in the Make Measurement Item dialog, even if the measurements have only been previewed on one timepoint. To measure selected timepoints the timepoints need to be selected in the image sequence view or in the time navigation bar, if no timepoints are selected the current timepoint is measured.

Measure All Timepoints

When this menu option is checked ROI or selections active in the view will be applied to all timepoints in the dataset and the measurements previewed in the table will be from all timepoints. Measuring all timepoints can take much longer than measuring a single timepoint. Measurement operations that rely on the time component of the data will not be previewed in the Measurements View unless **Measure All Timepoints** is checked.

Hide Measurements

Allow the image to be displayed in a larger window by hiding the Measurements table, if not required. **Hide measurements** changes to **Show measurements** to allow the table to be revealed again.

Measurements Table or Histogram

The Measurements table provides numerical information about the objects found in the image above. This numerical information can also be displayed as a simple histogram by clicking on the Histogram tab.

This numerical information is only shown while objects are selected either by a user drawn ROI or a Measurements protocol.

- n Store measurement information by creating a measurement item; select **Make Measurement Item...** from the Measurements menu.

- n Choose to **Hide** or **Show Measurements** from the Measurements menu to hide this table.
- n Show only measurements of a particular type, objects, lines or points by selecting the appropriate option from the drop-down at the top of the table.
- n Sort the table by the contents of one column by clicking on the column heading, click again to reverse the sort. An arrow in the column header indicates that this column is sorting the data.
- n To change the columns shown select **Columns...** from the Measurements menu and check or uncheck column titles in the list.
- n Rearrange columns by clicking on the column heading and dragging that heading to another position, a red insertion line shows where the column will be placed.
- n Fit the column widths to the data enclosed by selecting **Autosize Columns** from the Measurements menu.

Histogram Tab

Click on the histogram tab to switch to a histogram that displays one column from the table at a time. Use the histogram to find patterns in a selected item property.

Choose the data to be shown from the drop-down list of those available.

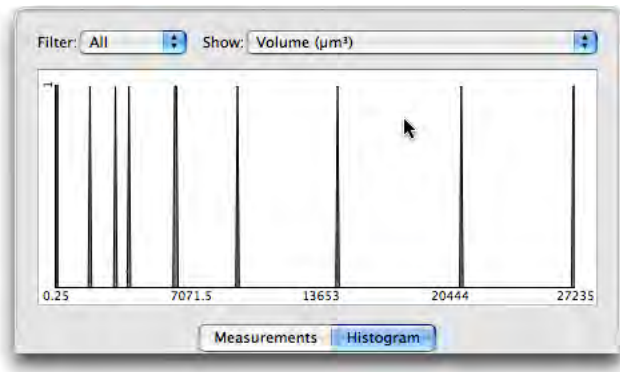

Creating Measurement Protocols

Measurement protocols are the most powerful way of selecting and measuring objects. Protocols are made up of tasks and are built by dragging tasks from the list in the bottom left hand pane into the protocol area. Feedback into the view shows where objects have been found and numerical information is listed in a measurement table below the image. Measurements protocols start with Finding tasks, after which the selection is refined by the addition of further tasks.

A selection of example protocols are installed with Volocity. Select from recently used protocols in the Measurements view protocol pane or select Measurements menu **Restore protocol...** to view all saved protocols.

The order of tasks in the protocol affects the result. Tasks lower down in the list work only on the results of tasks higher up in the protocol. The task flow is indicated by an arrow.



A set of tasks starting with a "Find Objects" task is known as a series. It is possible to have more than one series in a single protocol.



Measurement Protocol Tasks

Protocol tasks are grouped by function. The functions are ordered according to the order they are used in typical protocol creation. Within each function tasks are arranged alphabetically.

- n Drag and drop the appropriate task name from the list to the [ame; above to add to the protocol. The insertion point shows where the task will go.
- n Double click on a task name in the list to add it straight to the bottom of the protocol.
- n Move tasks around by dragging and dropping, the insertion point is shown.
- n Remove a task from the list by clicking the cross.

Some information is in the primary task area and always displayed. There may be additional information; this is accessed by clicking on the cog icon to show a secondary dialog.

Measurement Protocol Tasks

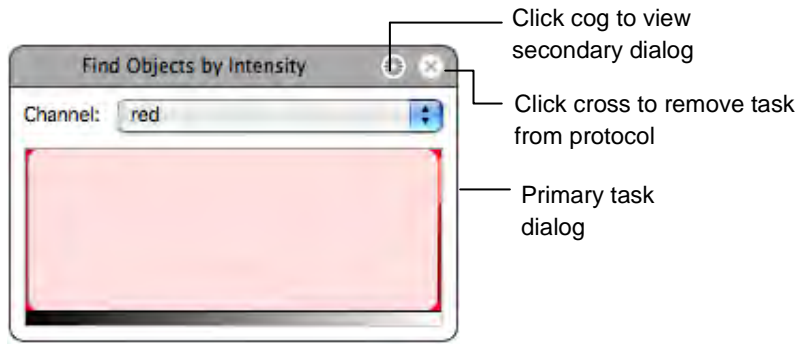

Each of the available tasks is described in more detail below.

Finding

Find Objects tasks have a control to select the channel in which the objects are to be identified. It is not possible to select a reference channel as the target for a Find Objects task.

Find 2D Nuclei

This task will detect nuclei in many images without the need to add any additional tasks to the protocol. This task will operate on 2D images only. This task might be helpful if the channel in which the nuclei are labelled has high and/or variable levels of background across the image since it is independent of absolute intensity. These factors may make the nuclei difficult to isolate with other Find Objects tasks. Find 2D Nuclei operates on the assumption that the objects of interest are represented by higher intensities against darker backgrounds e.g. fluorescent images and will therefore not operate on brightfield images.

Although developed specifically for finding nuclei this task might also be useful for finding any object with ovoid shape filled with staining.

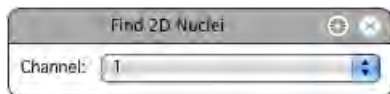

Click on the cog to open the secondary dialog and adjust parameters of the task.



Separate touching nuclei with a separation guide of: Reducing this distance will increase the number of nuclei found by increasing the amount of splitting.

Reject nuclei with an area of less than: Reject objects detected, or created by the splitting process, by size. Objects smaller than the expected size of the nuclei of interest can be excluded this way.

If you wish to exclude objects greater than a given size use an **Exclude Objects by Size** task in the protocol.

This task is not available on a PowerPC Macintosh system e.g. G5 or G4.

Find 2D Spots

This task will detect objects that can be identified as bright spots against a darker background i.e. small objects with one well expressed intensity maximum. This task will often find objects in images where the background varies across the image and may be useful where other Find Objects tasks have not been successful. Find 2D Spots operates on the assumption that the objects of interest are

represented by higher intensities against darker backgrounds e.g. fluorescent images and will therefore not operate on brightfield images.

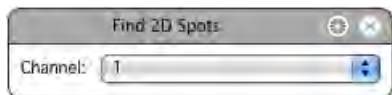

Objects found by this task are marked as points centred on one voxel. This task therefore identifies locations as coordinates, there is no morphological information available. Local intensity maxima are found and then incorrectly classified spots removed.

Click on the cog icon to open the secondary dialog and configure the parameters of the task.

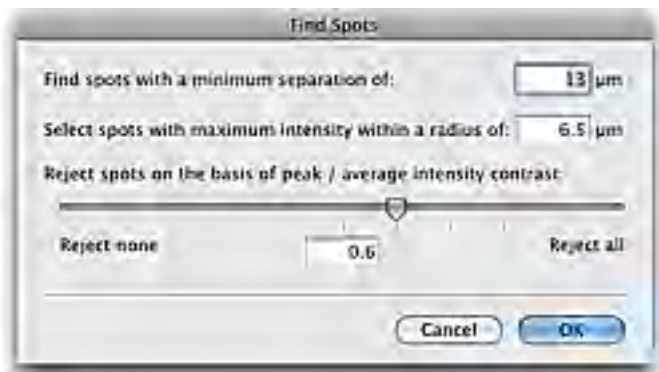

Find spots with a minimum separation of: A pixel intensity will count as an intensity maximum if it has the highest intensity within this radius. Decreasing this distance will increase the number of potential spots. Spots that are excluded by this parameter will not be included again regardless of other settings.

Select spots with a maximum intensity within a radius of: This parameter relates to the approximate radius of each spot object. Increase this value when working with larger spots. This radius also determines the radius within which contrast will be calculated.

Reject spots on the basis of peak/average intensity contrast: Reject spots that are considered noise by comparing peak intensity to local background intensity.

It might be necessary to use other tools to define the areas within which to search for spots. This might be the only way to exclude spots that have been found in the background or cell compartments that are not relevant to the study.

This task is not available on a PowerPC Macintosh system e.g. G5 or G4.

Find Objects Using % Intensity

Find Objects tasks select voxels according to intensity or color information. This task selects voxels according to % intensity.

Intensities within the current volume are represented as a percentage considering the highest intensity value in the volume as 100%. This removes the need to select by absolute intensity values and may work better for time resolved data sets.

The primary task shows text entry boxes to set the lower and upper limit of the selection.

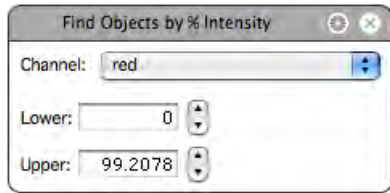

Click on the cog icon to show the secondary dialog. This shows a histogram of the current volume. Number of voxels is along the Y-axis; color or intensity values are along the X-axis.

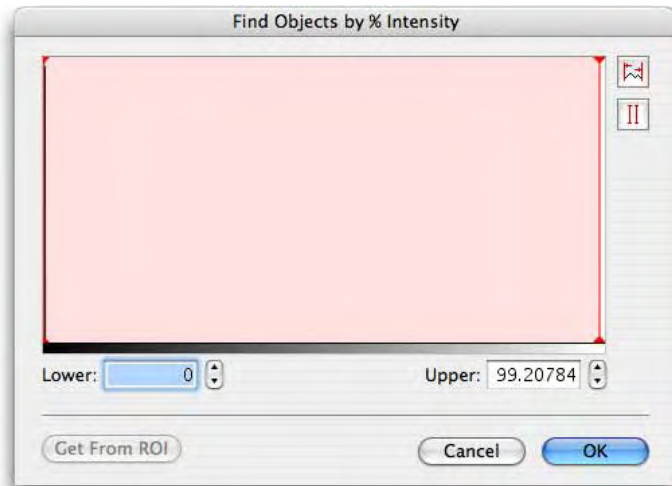

Click on the vertical red lines in the histograms and drag them to change the selected range of values.

Change the Y-axis of the histogram to see detail more clearly, cycling through four possible resolutions; linear, log, base 10 and base 100. To do this:

Windows: Ctrl-click in the histogram area

Mac: Alt-click in the histogram area



Select all Values. Select this tool to display the maximum range of values for the threshold mode that you have selected.



Invert Region of Selection. Select this tool to reverse the area of selection on the histogram.

Get From ROI will set the minimum and maximum thresholds to the minimum and maximum intensity value found within an ROI active on the Image

Find Objects Using Intensity

This task selects voxels according to specified intensity threshold values.

The primary task shows a histogram of the current volume. Number of voxels is along the Y-axis; intensity values are along the X-axis.



Click on the vertical red lines in the histogram and drag them to change the selected range of values. Tooltips show the intensity values.



The secondary dialog shows a larger histogram of the current volume. Text boxes allow direct entry of intensity values for the thresholds.

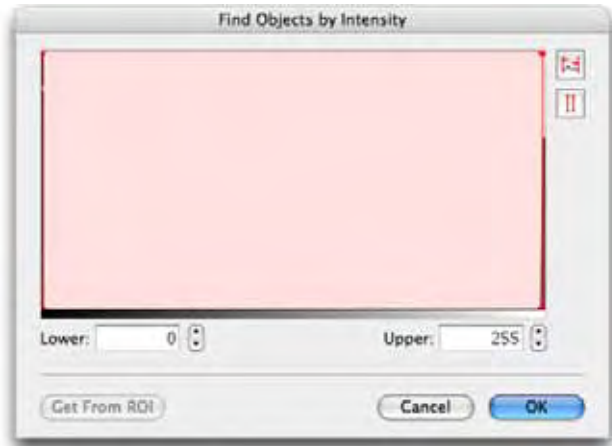

Click on the vertical red lines in the histograms and drag them to change the selected range of values.

To see detail in the histogram more clearly change the Y-axis, cycling through four possible resolutions; linear, log, base 10 and base 100 with each click in the histogram area. To do this:

Windows: Ctrl-click in the histogram area

Mac: Alt-click in the histogram area



Select all Values. Select this tool to display the maximum range of values for the threshold mode that you have selected.



Invert Region of Selection. Select this tool to reverse the area of selection on the histogram.

Get From ROI will set the minimum and maximum thresholds to the minimum and maximum intensity value found within an ROI active on the Image

Find Objects in ROI

This task will incorporate the objects within an ROI into the protocol. This allows those objects to be included in later processing.

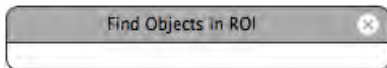

Find Objects Using HSI

This task selects voxels according to hue, saturation and intensity color information.

The primary task shows three histograms of the current volume. Number of voxels is represented along the Y-axis; hue, saturation and intensity values are along the X-axis in each histogram.

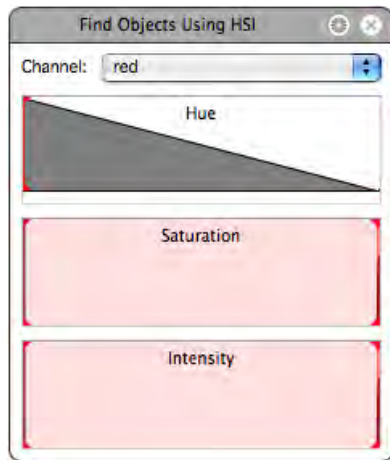

Click on the red vertical lines in the histograms and drag them to change the selected range of values. Tooltips appear when the cursor is held over the histogram to show values.

The secondary dialog shows a larger histogram of the current volume.

Text boxes allow entry of values as an alternative means of setting thresholds.

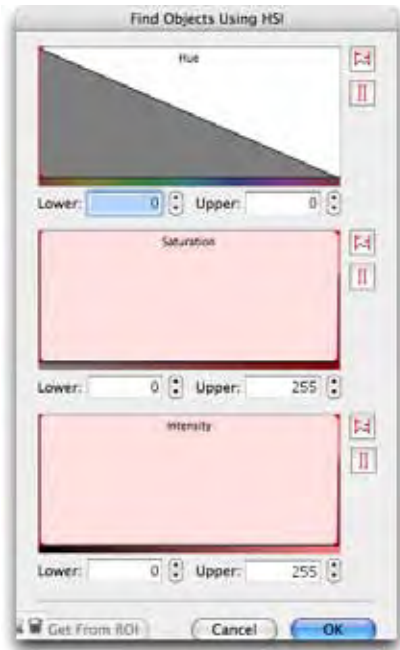

Click on the red vertical lines in the histograms and drag them to change the selected range of values.



Select all Values. Select this tool to display the maximum range of values for the threshold mode that you have selected.



Invert Region of Selection. Select this tool to reverse the area of selection on the histogram.

Get From ROI will set the minimum and maximum thresholds to the minimum and maximum values found within an ROI active on the image.

Find Objects Using RGB

This task selects voxels according to RGB color information.

The primary task shows three histograms of the current volume. Number of voxels is represented along the Y-axis; red, green and blue intensity values are along the X-axis in each histogram

Click on the red vertical lines in the histograms and drag them to change the selected range of values. Tooltips show values.

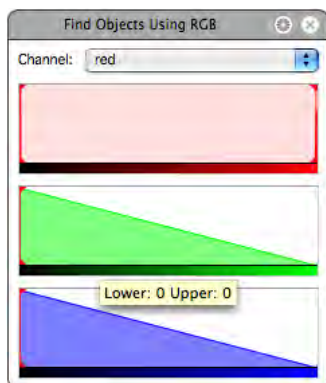

A secondary dialog shows larger histograms, which because of the increased scale may be easier to use for fine adjustments.

Number of voxels is shown along the Y-axis; color or intensity values along the X-axis.

Text boxes allow entry of values as an alternative means of setting thresholds.

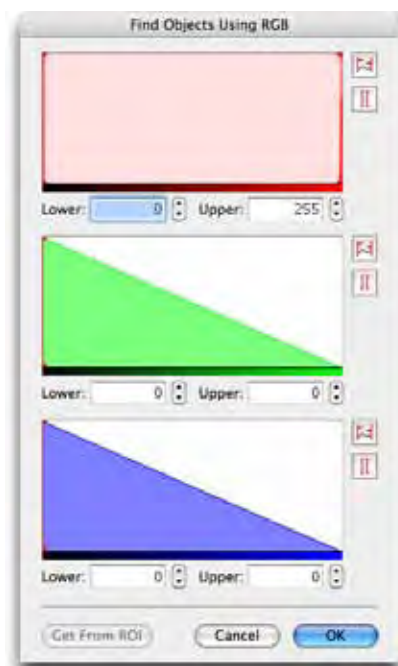

Click on the vertical red lines in the histograms and drag them to change the selected range of values.



Select all Values. Select this tool to display the maximum range of values for the threshold mode that you have selected.



Invert Region of Selection. Select this tool to reverse the area of selection on the histogram.

Get From ROI will set the minimum and maximum thresholds to the minimum and maximum values found within an ROI active on the image.

Find Objects Using SD Intensity

This task selects voxels according to intensity information.

Intensities within the current volume are represented as standard deviations above or below the mean intensity. This removes the need to select by absolute intensity values and may work better for time resolved data sets.

The primary task shows text entry boxes to set the lower and upper limit of the selection in numbers of standard deviations. Positive values are above the mean, negative values are below the mean. Uncheck the upper or lower limit boxes to allow everything above or below a set point to be selected.

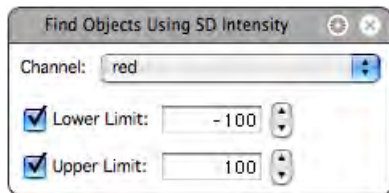

Click on the cog icon to open the secondary dialog for this task. The secondary dialog shows a histogram of the current volume; with number of voxels shown along the Y-axis, color or intensity values are along the X-axis. Superimposed over the histogram is a curve (in green) showing the normalized intensity. Vertical green lines are shown at the mean intensity and at each standard deviation above and below the mean. Data may therefore be thresholded based on a set number of standard deviations around the mean.

Set lower and upper limits by entering the value of standard deviation at which the limit is to be set. The mean intensity is at 0 standard deviations and standard deviations below the mean intensity have negative values.

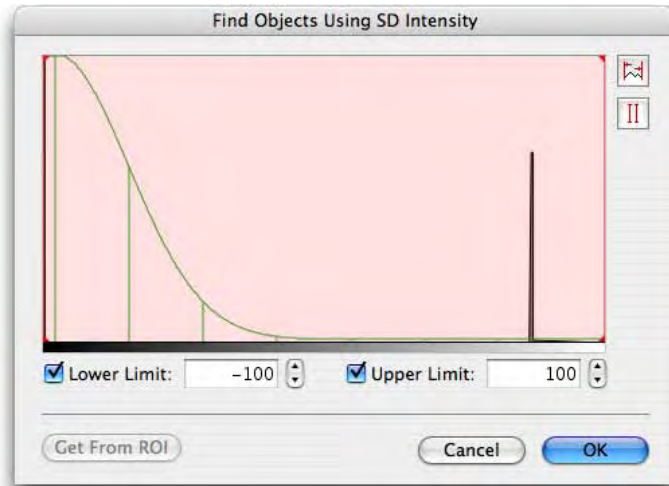

Click on the red vertical lines in the histograms and drag them to change the selected range of values .



Select all Values. Select this tool to display the maximum range of values for the threshold mode that you have selected.



Invert Region of Selection. Select this tool to reverse the area of selection on the histogram.

Get From ROI will set the minimum and maximum thresholds to the minimum and maximum values found within an ROI active on the image.

Processing

Close Objects

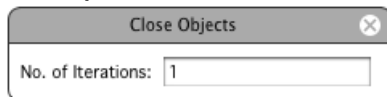

A close is a filtering operation performed on detected objects. A Close Objects task is used after objects have been detected by one of the Finding tasks. A close is a dilation operation followed by an erosion. Each iteration is a repetition of the dilate then close process. Close Objects will serve to close gaps within or between objects.

Dilate Objects



Dilation is a filtering operation performed on the objects detected by the measurement protocol up to that point. A diamond shaped kernel is passed over the selection so that each voxel in the selection is considered with 6 of its neighbors. In each case the central voxel is set to the highest value of itself and its neighbors. This has the effect of making the objects found by the selection bigger.. The dilation is repeated the specified number of times (iterations). This has the effect of expanding the object by that many voxels.

Erode Objects

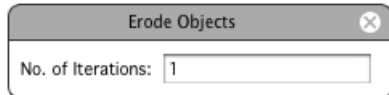

Erosion is a filtering operation performed on the objects detected by the measurement protocol up to that point. A diamond shaped kernel is passed over the selection so that each voxel in the selection is considered with 6 of its neighbors. In each case the central voxel is set to the lowest value of itself and its neighbors. This has the effect of making the objects found by the selection smaller. The erosion is repeated the specified number of times (iterations). This has the effect of shrinking the object by that many voxels.

Fill Holes in Objects

Objects must have been found using any of the **Find Objects** tasks earlier in the protocol.

If any of the objects identified have holes in them, this task will fill those holes provided that they are surrounded in all dimensions by a contiguous wall of voxels. For example, a hardboiled egg has a white that completely surrounds the yolk. So, the yolk is completely surrounded on all sides. Therefore, if you were to select the white and then fill holes, the whole volume of the boiled egg will be selected including the yolk.

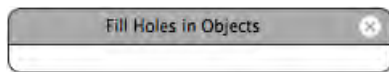

Open Objects

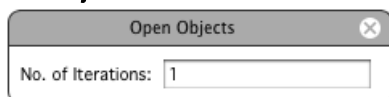

An open is a filtering operation performed on detected objects. An Open Objects task is used after objects have been detected by one of the Finding tasks. An open is an erosion followed by a dilation. Each iteration is a repetition of the erode then dilate process. Objects separated by the erosion part of an open iteration will be prevented from joining together again by the following dilation.

Open object s will serve to separate objects by reducing them in size until they no longer touch then growing them again so they approximate their original sizes.

Remove Noise from Objects

Use this task to apply a median filter to the selection already made. The selection is made by a **Find Objects** task earlier in the series.

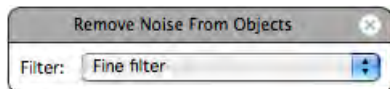

The size of the filter applied is selected in the drop-down on the task.

From the smallest fine filter to the largest very coarse, the median filter matrix is increased in size. The time taken to apply the filter and the degree of filtering also increase.

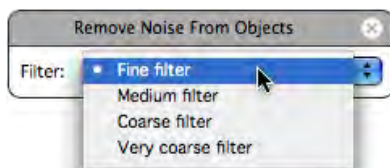

Separate Touching Objects

This function can assist in the separation of two or more objects that a **Find Objects** task has identified as one. The distance of each voxel from the surface of the selection is examined and, if the distribution of the voxels indicates that two or more objects are present, a one-pixel thick row of voxels is removed between them to create separate objects.

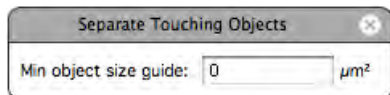

The minimum size guide may be optionally set to the typical size of a single object. This refines the task by preventing separation if the distance between two new objects would be too small.

Filtering

Clip Objects to ROI

Objects must have been found earlier in the protocol.

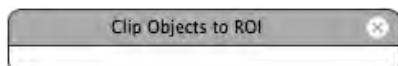

Drawing a region of interest in the image and using this task will clip the result to the bounds of the ROI. This may mean some objects are cropped.

Use **Exclude Objects not Touching ROI** to ensure that any objects that intersect with the ROI are included.

Exclude Objects by Shape

Objects found earlier in the protocol can be removed if they do not meet criteria for shape. This task would be used later than a **Find objects** task in a measurements protocol.

Select the required shape from the drop-down list: either one of the predefined shapes or the Custom Shape.

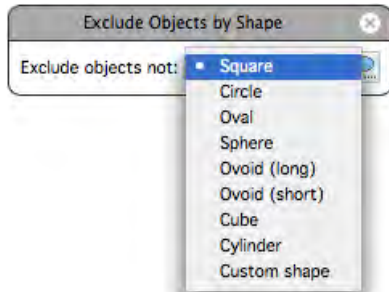

Custom shape: Custom shape allows you to create bespoke shapes using the XY, XZ and YZ cross sections through an ellipse, rectangle or triangle. The custom shape is saved when the protocol is saved.

To create a custom shape, select **Custom shape** from the drop-down menu and click on the button to launch the Shape Preview window. Select the axes and use the slider controls to adjust values manually.

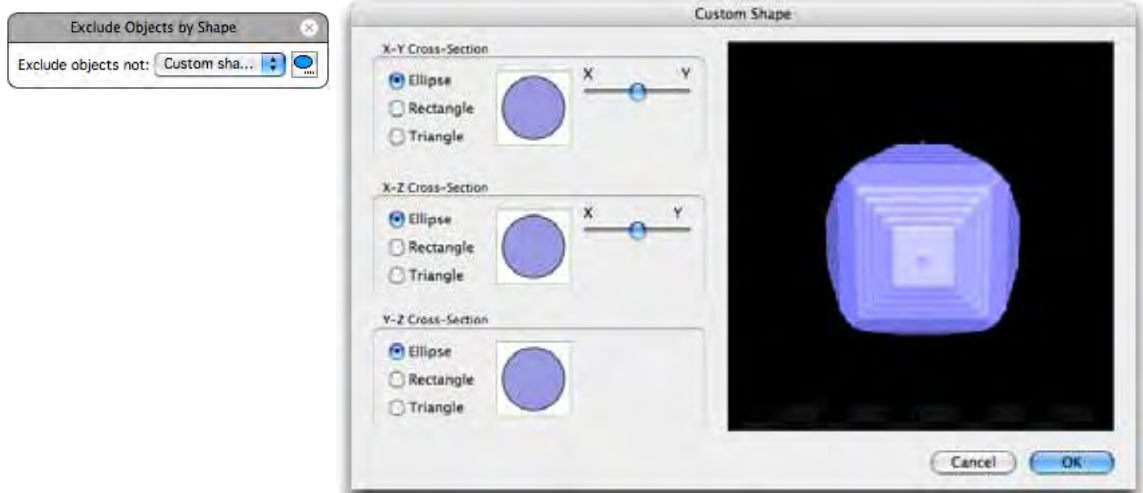

Ellipse and Rectangle: When the XY slider is set to the central point the ratio between the X and Y axis (or X and Z) is 50-50. As the slider is moved towards X, the length of the X axis will reduce and increase in Y and vice-versa. The same rules apply for the XZ sliders. The YZ ratio is taken from the XY and XZ controls.

Triangle: It is possible to skew the angles of the triangle to achieve all possible dimensions from an equilateral triangle (the slider is set at the central point) to a right-angled isosceles triangle (the slider is set to the extreme right or extreme left).

Exclude Objects by Size

Objects found earlier in the protocol can be removed if they do not meet criteria for size. This task would be used later than a **Find objects** task in a measurements protocol.

The task excludes objects greater than or smaller than a defined size.

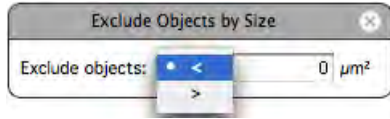

Exclude Objects not Touching ROI

Objects must have been found earlier in the protocol.

Drawing a region of interest in the image and using this task will show only objects that intersect with the ROI.

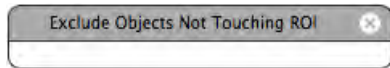

Exclude Objects Touching Edge of Image

Objects must already have been found by the protocol. This task will remove any of those objects touching the edge of the sample in the X,Y or Z planes. On datasets with small Z dimensions, this may remove too much from the selection.

When working with 2D data the Z dimension is not considered as the edge of the image because this would mean every object would be excluded.

**Combining****Combine Objects**

This task merges the objects found by one series of measurements task with the objects found by another series.

The first series of objects must include a **Retain Objects** task that names the first set of objects so that they can be specified in this task.

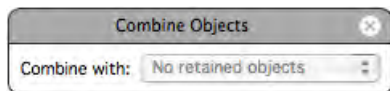

Exclude Non-Touching Objects

This task keeps only those objects in a second series that touch objects in a first series.

The first series of objects must include a **Retain Objects** task that names the first set of objects so that they can be specified in this task.



Exclude Touching Objects

This task keeps only those objects in a second series that do touch objects in a first series.

Objects in a series must be retained for use in this task using the **Retain Objects** task which will give each set of objects an identifier. Use two sets of retained objects or one set of retained objects and the current selection.



Exclusively Combine Objects

The first series of objects must include a **Retain Objects** task that names the first set of objects so that they can be specified in this task.

The result shows just those areas where the objects from one series are found, not both.



Internalize Measured Objects

Objects found and measured in one series will be related to the objects found by another series by identifying the objects that are found inside other objects with a parent ID. Objects from the second series that are within the same object from the first series will be given the same parent ID. Objects in a series must be retained for use in this task using the Retain Objects task. Use two sets of retained objects or one set of retained objects and the current selection. Objects found by one series will be related to the objects found by another series according to one set of objects being inside or outside the other.

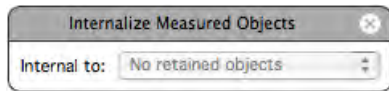

Objects from the second series that are within the same object from the first series will be given the same parent ID.

The first series of objects must include a **Retain Objects** task which will name the first set of objects to enable them to be specified in this task.

Intersect Objects

Objects are found by one series, a second series finds a different population. **Intersect objects** will find just the areas where both sets of objects overlap.

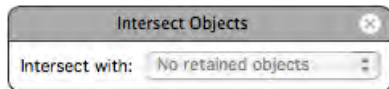

A **Retain Objects** task must be used in the first series to name the first set of objects to enable them to be specified in this task.

Invert Objects

This task will invert the selection made by the series so far. This may be useful in situations when it is easier to select background or unwanted objects and reversing the selection serves to select the required objects.



Subtract Objects

Subtract the area masked by the retained objects from one series from the objects found in the current series.



Measuring

Filter Measurements

Objects that have been found by the protocol are listed in the table below the image. If this table is not visible choose **Show Measurements** from the Measurements menu.

The list of objects found may be further refined by filtering on any of the measured parameters.

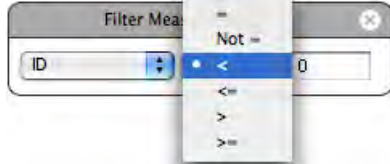

Measure Line Profiles

Measure intensity values along a line drawn with the line tool. Intensity values are interpolated from neighboring voxels. Intensity is sampled at intervals along the line to generate the table of intensity values. Sample points are chosen at the highest resolution of the data out of X, Y and Z resolutions. A measurement row is added for each line. Line length and width are recorded for each line. A measurement row is added for each sample point along the line.



Branched lines cannot be measured for a line profile and are therefore ignored by this task..

When measuring line profiles in 3D data be careful of line placement. Use the XYZ mode of the Measurements view to ensure the line is placed as desired it can appear to float to the top slice.

Measure Lines

This task ensures that line measurements are recorded.

Draw lines using the line tool available from the tool bar. As lines are drawn the line length is displayed in the Measurements table below the image. This is the default display.

The default display may change as other objects are found and the line measurements will no longer be displayed. If they are no longer displayed in the table below the image, they will not be recorded in any measurement item created unless you include a **Measure Lines** task in your protocol.



The secondary dialog of the Measure Lines task shows checkboxes to select the measurements to be made. Currently, line length is the only measurement available for lines.

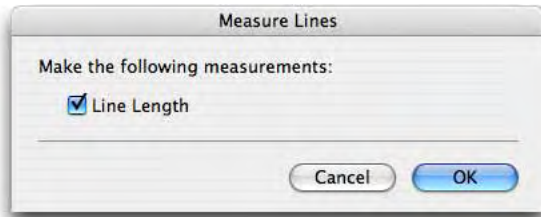

Measure Objects

Objects are selected either by using the ROI tools available from the tool bar or by using **Find Objects** task in a measurement protocol.

As objects are selected, measurements are displayed in the Measurements table below the image. This is the default display. For each object found the table will display:

- n Voxel/Pixel count
- n Volume (μm^3)/Area (μm^2)
- n Min, Max, Mean and Sum intensity values. Each channel in the data set will have a set of intensity columns.
- n Centroid position in pixels and micrometers
- n Surface Area (μm^3)/Perimeter (μm^2)

The default display may change as other objects are found and the object measurements will no longer be displayed. If they are no longer displayed in the table below the image, they will not be recorded in any measurement item created. Add a Measure Objects task to make the required measurements.

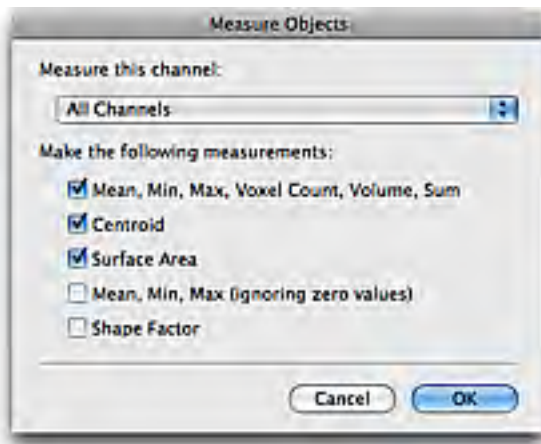

Intensity measurements ignoring zero are useful when working with data where background values are always zero. This occurs after certain processing steps, for example ratio and FRET calculations.

A **Measure Objects** task may also be used partway through a protocol to record measurements at that point and again later to measure a new set of measurements.

Once the **Measure Objects** task is included, default measurements will not be generated.

The centroid of an object is the unweighted centre. It is calculated by taking the average position of the voxels making up the object. Thus, the average x coordinate of the voxels determines the x coordinate of the centroid and the average y coordinate of the voxels determines the y coordinate of the centroid.

Surface area of objects is measured by fitting a "skin" to the surface of the mask layer identifying the object at the voxel level. Triangles are then fitted to each cluster of voxels on the surface of the object. The area of each triangle is measured; the sum of triangle areas for each object gives the surface area. There is no surface simplification for measurement. It is important, when using any measurement, to ensure that results are statistically significant compared to any measurement error or noise. This is especially important with surface area measurements where noise and surface features can have a considerable impact on the measurement.

Measure Points

Mark points using the point tool available from the tool bar.

As points are marked, the point location is displayed as a coordinate in the Measurements table below the image. This is the default display.

The default display may change as other objects are found and the point positions will no longer be displayed. If they are no longer displayed in the table below the image, they will not be recorded in any measurement item created unless a **Measure Points** task is used.



The secondary dialog of the **Measure Points** task shows checkboxes to select the measurements to be made. Currently, **Position** is the only measurement available for points.

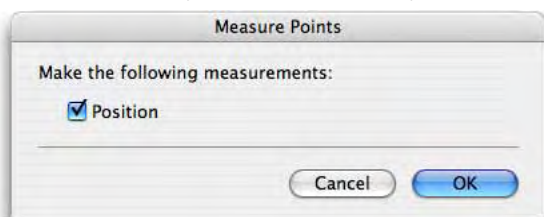

Measure Skeletal Length

This is an additional measurement that may be made from objects.

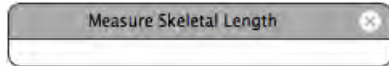

Skeletal length is calculated by first thinning or skeletonising the object from all sides until a single voxel line is left. This measurement is best suited to elongated shapes. The direction of the line is elongated to meet the edges of the object and the length of this line is the skeletal length. For objects where the skeleton branches, the skeletal length is measured as the longest traverse across the object without crossing a point more than once.

Skeletal diameter is the diameter that a cylinder would have if it had a length equal to the skeletal length of the object (determined as above) and a volume equal to the object's measured volume.

It is derived using the equation for the volume of a cylinder.

$$V = \pi r^2 l$$

Measure skeletal length populates the measurement columns skeletal length and skeletal diameter for each measured object. For each skeletal length a measurement row is added. This row is a line measurement representing the skeletal length for the purpose of viewing feedback. The parent ID column of the row representing the skeleton will reflect the ID of the source object.

Miscellaneous

Auto Analyze

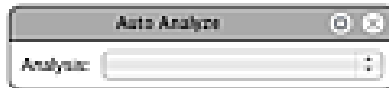

Analysis may be performed on data to illustrate patterns and trends that are not immediately apparent from the raw data. Analysis is performed in the Measurements item using the Analysis dialog. Analysis protocols may be saved for reuse and Volocity is installed with some example analysis protocols.

Use the Auto Analyze task at the end of a protocol to specify one of the saved analysis protocols to use. When in place this task will generate the analysis selected when a Measurement item is created. The command **Make Measurement Item....** in the Measurements menu will generate a Measurement item as will using a protocol containing the Auto Analyze task in the batch measurement operation.

For more information on Analysis in Measurement items see page 445.

Calculate Object Colocalization

Colocalization in the context of digital fluorescence imaging can be described as the detection of signal at the same voxel location in each of two channels. The two channels are made up of images of two different fluorochromes taken from the same sample area.



Calculate Object Colocalization will calculate the Pearson's Correlation and colocalization coefficients M_x and M_y for each object found by the series. Click on the cog icon to access the secondary dialog and configure the task.

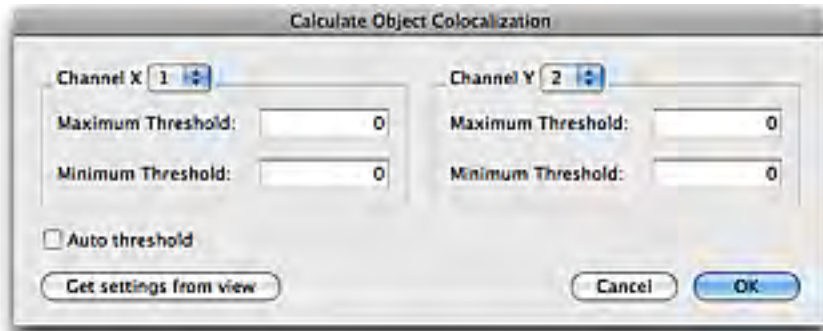

In the secondary dialog select the channels to be colocalized.

Thresholds are essential, enter the threshold intensity values for each channel. Voxels with intensity values below the minimum threshold and voxels with intensity values above the maximum threshold will be excluded from the calculations. Use minimum thresholds to remove intensities in each channel that are not significant in determining colocalization.

Alternatively, configure the colocalization view for the data set before working with the Measurements View and click **Get settings from view** to use these settings in the task.

To measure morphological and intensity information from objects include a **Measure Objects** task as well as the **Calculate Object Colocalization** task. Configure the secondary dialog of the **Measure Objects** task to record the required measurements.

See also the section on Colocalization starting on page 467.

Color Objects

When objects are found they are shown in the image area of the view using a colored overlay. By default each separate object identified is given a different color. It may be useful when working with objects to color them in a different way.

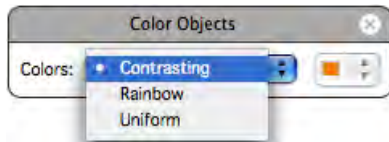

Use **Color Objects** in a series to apply a specific way of coloring a set of objects. Use anywhere below a find object task but above any measure task.

Comment



The comment task has no effect on object detection or measurement it may be used anywhere in a measurement protocol to provide information. Use comments in saved protocols to explain to other users what to do or why the protocol is created in a particular way.

Click on the cog to access the secondary dialog.



This allows the entry of free text. All the text entered here will be shown in the protocol, the task resizes to fit.

For examples of the comment task in use see the saved measurements protocols available with Velocity. Select **Restore Protocol...** from the Measurement menu and select any of the protocols in square brackets.

Group Measurements

This task identifies a set of measured objects, points or lines by adding an additional measurement column titled "Group" for each row of objects in the series. This column will be populated with whatever is in the Name field. This column can be used to identify the measurements as a group, even after tables have been exported as text.

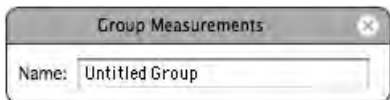

Make ROI from Objects

This task can be used to convert a selection into a region.

Restore Objects

This task updates the selection to show any objects that have been retained as a set previously.



Retain Objects

This task retains the objects found by that point in the protocol in a temporary way solely during the running of the protocol.



Filling in the name field allows the set of objects to be used later, by for example **Intersect** and **Combine Objects** tasks that process the output of one series of measurements tasks with the output of a previous series that has been retained.

Track Objects

This task is unique to time resolved data. The **Track Objects** task will place itself at the bottom of any protocol since objects must be found before they can be tracked.



The Measurements View only shows the protocol as applied to the current timepoint by default. It may be useful to turn on **Measure All Timepoints** in the Measurements menu to preview all the measurements over time and the tracks.

The Volocity tracking algorithms operate on centroid positions. A track is generated by connecting centroids to trace the path of a moving object. Different models are used to identify the most likely position for each object being followed in each timepoint.

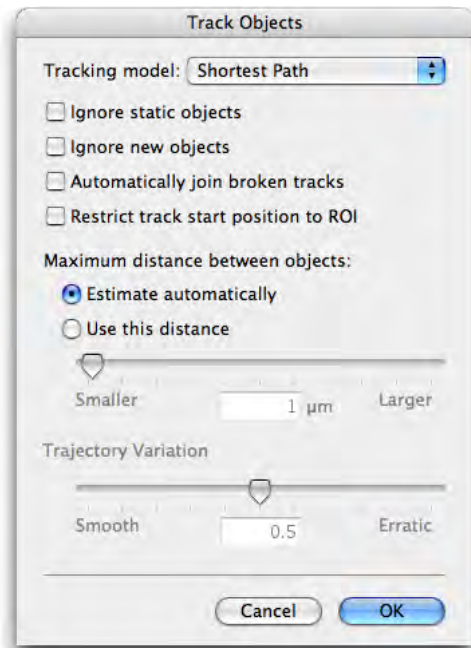

Click on the cog icon to access the secondary dialog for the **Track Objects** task. The **Shortest Path** model attempts to create tracks based on the criterion that the chosen matches between the populations of object centroids in any pair of timepoints have the minimum physical distance between them.

The **Trajectory Variation** model uses the Shortest Path model to first establish a likely track for an object between centroids in timepoint 1 and timepoint 2. The next centroid position of that object is determined by that which is consistent in both direction and speed. This model should be effective for objects that cross paths.

When the **Trajectory Variation** model is selected, the Trajectory Variation slider is used to alter the sensitivity of the algorithm to variation. Restricting the algorithm to smooth tracks can result in no tracks being found.

Other Options

- n If required, enable the **Ignore static objects** and **Ignore new objects** checkboxes.
- n **Automatically join broken tracks** is a feature that allows tracks to be continued, even if the object was not detected in periods of up to two consecutive timepoints along the trajectory.
 - n With **Automatically join broken tracks** off, the default setting, a track will terminate if a timepoint is reached where no centroid can be found that is likely to be part of the track based on the restrictions determined by the parameters entered in the **Track Objects** dialog.

- n When **Automatically join broken tracks** is on the tracking algorithm will join a partial track to another partial track beyond the missing section as long as the whole track has a consistent trajectory.

It may be appropriate to allow Volocity to **Automatically join broken tracks** where objects have not been measured in all timepoints along their path length. An object may fail to be detected in a timepoint because of factors such as noise or inconsistent illumination.

Users may also join tracks manually after the creation of a measurement item using the **Join Objects** option in the Raw menu. See page 431.

- n **Restrict track start position to ROI** requires an ROI to be drawn on the image. When this option is checked, tracks will only be measured if they start within the drawn ROI.
- n **Maximum distance between objects** must be set for both tracking models.
 - n **Estimate automatically:** Volocity will calculate a maximum, effective matching distance to use as an upper bound for possible motion tracking between timepoints in a sequence based on the size of the dataset ($\frac{1}{4}$ of the diagonal of the volume).
Volocity will then attempt to make a shortest path matching between the first two timepoints using this calculated upper bound. The maximum distance between objects calculated for this dataset is the average distance between all the matched object centroids in the first two timepoints plus one standard deviation. This value is then used for the maximum distance throughout the data set.
 - n **Use this distance:** Volocity will use the user-specified distance as the maximum limit for matching object centroids between timepoints.

Tip: Establish a maximum distance to set by scanning the time series and choosing two timepoints between which the greatest movement is apparent. Obtain a value to enter in the **Track Objects** dialog by measuring this movement using the line tool. Adjustment to this distance can be made for subsequent measurement, if required.

The tracking algorithm assigns a tracking ID to objects. If it determines that an object in a timepoint is the same as an object in a previous timepoint, it gives that object the same ID. The track (or line connecting all the objects with that ID) also has the same ID.

Manually Track Objects (Tools menu)

When it is not possible to use Volocity's automatic tracking algorithms to track moving objects within a time-resolved data set, manual tracking will allow you to create track objects in a Measurement item by manually marking the object location in each timepoint.

Open the image sequence containing the data you wish to track.

1. View the Image or Measurements View. These views allow use of the point and ROI tools which are needed to mark object locations.
2. Select **Manually Track Objects** from the Tools menu.
3. Follow the instructions given by the Manual Tracking wizard.

Clear, Save, Restore and Export Protocol

- n Select **Clear Protocol** from the Measurements menu to remove a protocol from the Measurements View without saving it.
- n Select **Save Protocol...** from the Measurements menu to save a protocol and use it again in the future. Protocols are stored as preferences at user level.

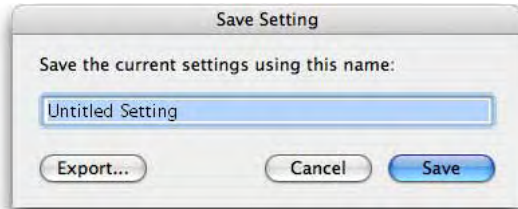

- n Select **Restore Protocol...** from the Measurements menu to restore an existing protocol and use it with the active Measurements View.

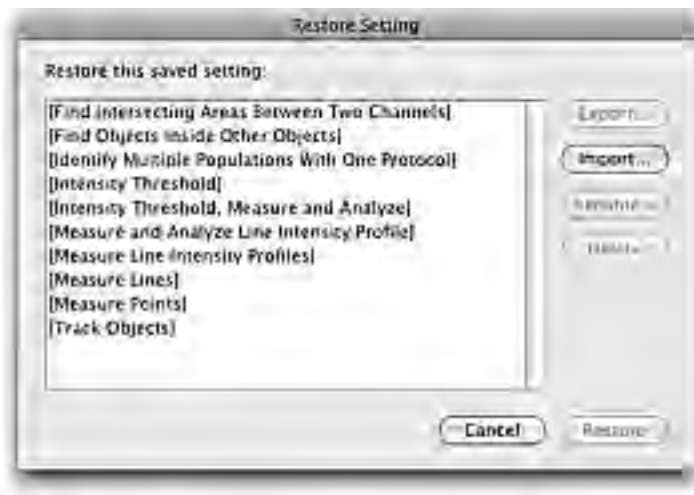

You can also use this dialog to manage protocols. It allows renaming and deletion of existing protocols. Use **Import...** to add a protocol exported as a settings file (.assf extension) to the protocol on the system.

- n To share protocols with other users, click **Export...** on either the Save Protocol dialog or the Restore Protocol dialog. This will create a settings file, with the extension .assf. Use the **Import ...** button on the Restore Protocol dialog to bring in a protocol in the settings file format.

Clear, Save, Restore and Export Protocol

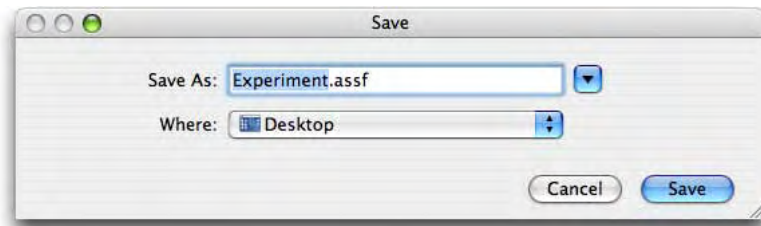

Batch Processing Measurements

1. Select **Measure...** from the Tools menu.

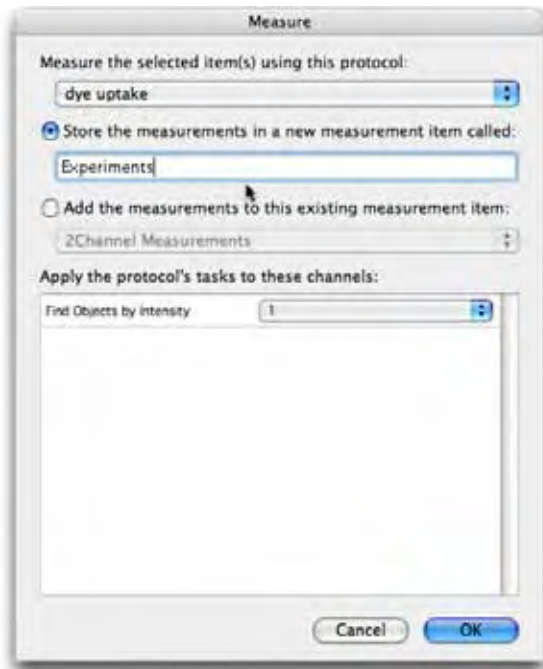

2. Select the protocol to be applied to the selected items from the drop-down menu, which lists all saved protocols by name.
3. Either, select **Store the measurements in a new measurement item called:** and enter a name for the Measurement item that will contain all the measurements made by the selected protocol on the selected items. Or, select **Add the measurements to this existing measurement item:** and choose from the measurement items that already exist in the library. In this case, all the measurements from all the selected items will be added to the measurements already in the table.
4. For each task in the protocol that operates on a specific channel (i.e. the Protocol dialog contains a drop-down for channel selection when the task is configured), there will be an entry under **Apply the protocol's tasks to these channels:** The drop-down lists the unique channel names found within the selected items. Channels with the same name will all be processed.
5. The Measurement item created will contain all the measurements made on all the selected items.

Measurement Items

Make Measurement Item

Once you are happy with the measurements from points, lines and regions marked on the Measurements View, use **Make Measurement Item...** from the Measurements menu to record measurements.

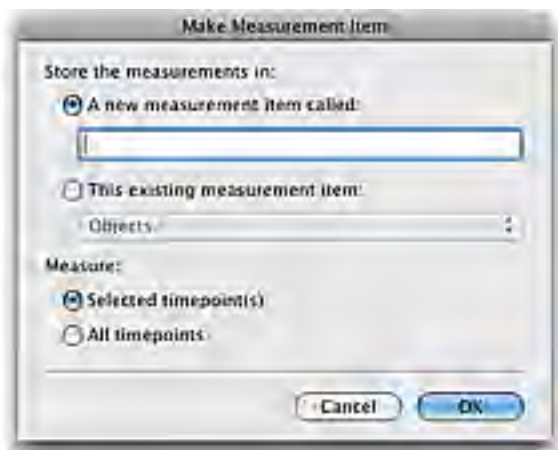

Timepoints are selected in the image sequence timeline view or in the time navigation bar, if no timepoints are selected the current timepoint is measured.

Volocity records measurements to the specified Measurement item. You can then view the measurements as a table. This table has a number of views.

A Measurements item is also created when a saved protocol is applied to selected items in the library (using the Measure dialog from the Tools menu).

Note: The **FRAP Analysis...** command in the Tools menu generates a measurement item. Designed specifically for FRAP analysis this measurement item will appear different from one created by other measurement actions in Volocity and you will interact with it differently. See "FRAP Measurement Item" on page 486.

There are now three stages that you can work through to extract patterns or trends from image data.

- n Organize and filter the raw data so that it is ready for analysis.
- n Analyze the raw data.
- n Chart the results.

Raw Data View

The initial table view shows the **Raw** measurement data.

Name	Type	ID	Item Name	Timepoint	Abs. Time	Rel. Time	Color	Voxel Co.	Volume	Min	Max	Mean	Sum	Centroid X	Centroid Y	Centroid Z
Object 8479	Object	8479	Experim...	2	14.57.3	120.948		6	0.301692	40	57	46.8333	281	308.333	93.3333	
Object 11701	Object	11701	Experim...	2	14.57.3	120.948		9	0.452518	40	57	45.7778	412	367.444	9.88889	
Object 13547	Object	13547	Experim...	2	14.57.3	120.948		10	0.50282	40	60	49.2	492	371.9	250.6	
Object 13478	Object	13478	Experim...	2	14.57.3	120.948		8	0.402256	40	75	51.375	411	360	288.75	8.8
Object 37416	Object	37416	Experim...	2	14.57.3	120.948		6	0.301692	40	55	47.3333	284	379.167	265.667	
Object 41711	Object	41711	Experim...	2	14.57.3	120.948		8	0.402256	42	75	49.5	396	133.125	309.125	10
Object 44960	Object	44960	Experim...	2	14.57.3	120.948		7	0.351974	42	52	45.7143	320	280.714	278.714	
Object 49385	Object	49385	Experim...	4	15.01.3	361.01		7	0.351974	39	56	47	329	273.857	378	0.7142
Object 45239	Object	45239	Experim...	4	15.01.3	361.01		6	0.301692	39	47	40.3333	242	203	438	
Object 66082	Object	66082	Experim...	4	15.01.3	361.01		6	0.301692	39	44	41.5	249	377.333	503	2.666
Object 69193	Object	69193	Experim...	4	15.01.3	361.01		6	0.301692	39	51	43.8333	263	376.5	243.167	3.666
Object 69314	Object	69314	Experim...	4	15.01.3	361.01		6	0.301692	39	69	47.8333	287	370.333	251.667	3.833
Object 69573	Object	69573	Experim...	4	15.01.3	361.01		6	0.301692	39	44	40	240	397.333	374	
Object 69837	Object	69837	Experim...	4	15.01.3	361.01		6	0.301692	39	45	41.5	249	373.5	295.667	3.666
Object 79561	Object	79561	Experim...	4	15.01.3	361.01		6	0.301692	39	48	40.6667	244	385.333	51.6667	
Object 88861	Object	88861	Experim...	4	15.01.3	361.01		11	0.553102	39	57	45.9091	505	377.091	284.636	6.909
Object 95418	Object	95418	Experim...	4	15.01.3	361.01		9	0.452518	39	50	43	387	341	308.556	8.888
Object 96716	Object	96716	Experim...	4	15.01.3	361.01		6	0.301692	39	49	42.8333	257	649.833	410.167	8.166
Object 96799	Object	96799	Experim...	4	15.01.3	361.01		6	0.301692	39	50	42.3333	254	358.333	436.833	7.833
Object 99363	Object	99363	Experim...	4	15.01.3	361.01		6	0.301692	40	54	46	276	326	114.167	
Object 101088	Object	101088	Experim...	4	15.01.3	361.01		6	0.301692	39	45	42.8333	257	271.167	251	8.166
Object 106622	Object	106622	Experim...	4	15.01.3	361.01		7	0.351974	39	58	46.8571	328	235.286	178	10.14
Object 107038	Object	107038	Experim...	4	15.01.3	361.01		7	0.351974	39	58	47.1429	330	193.714	214.714	9.142
Object 107219	Object	107219	Experim...	4	15.01.3	361.01		6	0.301692	39	56	46.3333	278	551.667	227.833	9.166
Object 110246	Object	110246	Experim...	4	15.01.3	361.01		6	0.301692	39	56	43.3333	260	468.333	459.5	10.16
Object 114921	Object	114921	Experim...	4	15.01.3	361.01		7	0.351974	39	57	43.5714	305	458.286	317.571	10.71
Object 123863	Object	123863	Experim...	5	15.03.3	480.177		6	0.301692	636	1008	757.333	4544	104	341.667	0.1666
Object 124067	Object	124067	Experim...	6	15.05.3	601.049		11	0.553102	1241	2017	1649.82	18148	319.273	19.6364	1.818
Object 124119	Object	124119	Experim...	6	15.05.3	601.049		26	1.30793	1025	1741	1258.85	32730	111.346	218	7.846
Object 124156	Object	124156	Experim...	6	15.05.3	601.049		8	0.402256	1147	1757	1373.62	10989	132.125	221.875	

There are a number of ways of organizing and filtering the raw data so that you can review it before analysis.

Working with Columns

Column headings show which measurements were made. N/A in a column means the data is not available. For example, if a session contains both line and region measurements, **Total Length** is not a relevant measurement for a region so that column will have N/A against all region rows.

- n To reorganize columns click the column heading, drag it to its new position and release.
- n To sort columns click on the column heading—an arrow shows that the column is sorted and the direction of the arrow indicates whether the sort order is ascending or descending. Click again to

reverse the sort. For example: sort on the **Name** column to group together the same types of measurement. Sort on the **Voxel Count** column to find the largest and smallest objects.

- n To change the width of a column click on the cell border and drag.
- n To resize all columns to fit contents, select **Autosize Columns** from the Raw menu.
- n To hide/show columns select **Columns...** in the Raw menu.
All columns that can currently be shown will be displayed in the dialog.
To show a column, check the box corresponding to the column name and click **OK**. (Click **Hide All** or **Show All** to uncheck/check all boxes respectively.)

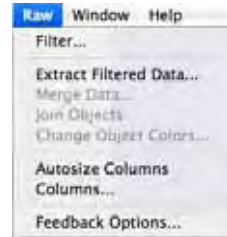

Filter

Set up filters to hide unwanted data. Quick filtering on the basis of type of measurement can be achieved with the **Filter** drop-down. Choose to show just object measurements or just line measurements.



For more advanced filtering select **Filter...** from the Raw menu or click on the filter button at the top of the window.

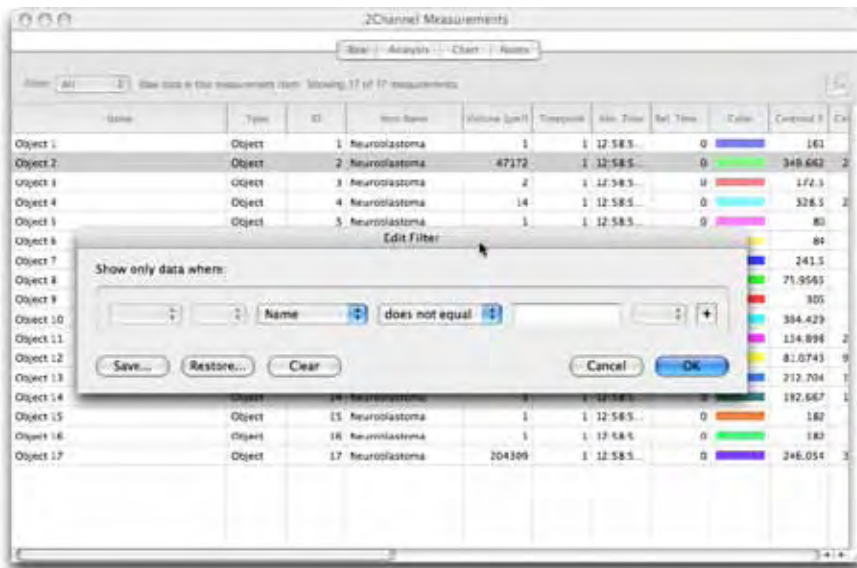

Filter out rows by selecting the column to filter on and entering values to select by. And/OR expressions are permitted, as is the use of brackets.

Click on the **Save...** button to save a filter as a preference to easily access the same criteria again.

Once a filter is applied the number of filtered measurements is displayed. To cancel a filter open the Filter dialog and click **Clear**.

Viewing Tracks

Tracks measured are added to the same Measurements item as the objects. Use the quick filter drop-down to view only tracks.

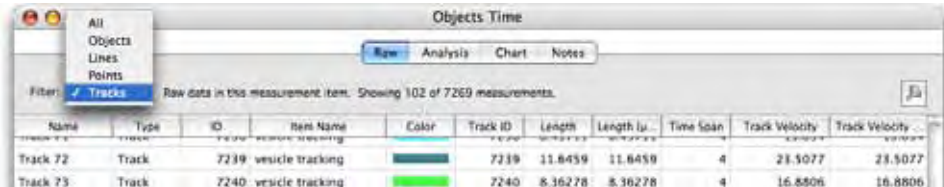

The screenshot shows a window titled 'Objects Time' with a menu bar containing 'Raw', 'Analysis', 'Chart', and 'Notes'. A dropdown menu is open over the 'Raw' button, listing 'All', 'Objects', 'Lines', 'Points', and 'Tracks', with 'Tracks' selected. Below the menu, a status bar reads 'Raw data in this measurement item. Showing 102 of 7269 measurements.' The main area contains a table with the following data:

Name	Type	ID	Item Name	Color	Track ID	Length	Length (u...)	Time Span	Track Velocity	Track Velocity ...
Track 72	Track	7239	vesicle tracking	[Blue]	7239	11.8459	11.8459	4	23.5077	23.5077
Track 73	Track	7240	vesicle tracking	[Green]	7240	8.36278	8.36278	4	16.8506	16.8506

Select a track row in the Measurements Item to show feedback of the track within the image data that it came from. If that data is open to a view that supports feedback, the objects associated with that track, objects with the same tracking ID, will also be shown as Measurements feedback.

Use the feedback options to show or hide the objects or to show the objects only in the current timepoint. This is useful if you want to make a movie showing the objects moving along their tracks.

Extract or Merge Data

You can create new Measurements items from existing items by combining their contents.

Where applying a filter has created a new table that you would like to process further, use **Extract Filtered Data...** from the Raw menu to create a new Measurement session containing just that data. Name the new Measurement Item to be created.

To add the contents of the current table to a Measurement Item that already exists in the library use **Merge Data...** This tool allows you create tables that are combinations of other data.

- n **Remove duplicate rows** will ensure that the same measurement is not repeated.
- n **Merge similar rows** will ensure that different measurement criteria, indicated by the column heading, for the same object are kept in one row, not spread over two or more.

Join Objects

This feature can be used to join two or more objects, polylines or tracks. Any number of objects can be joined.

Select the objects to be joined in the table and click **Join Objects** in the Raw menu. A new object will be created in the table, consisting of the union of all selected objects.

Note that this object may be non-contiguous, that is, it may contain two distinct areas which do not touch. However, for the purposes of measurement and feedback it is considered to be a single object.

This new object will be re-measured, with all the appropriate measurements. Note that the previously selected objects are not deleted or altered in any way.

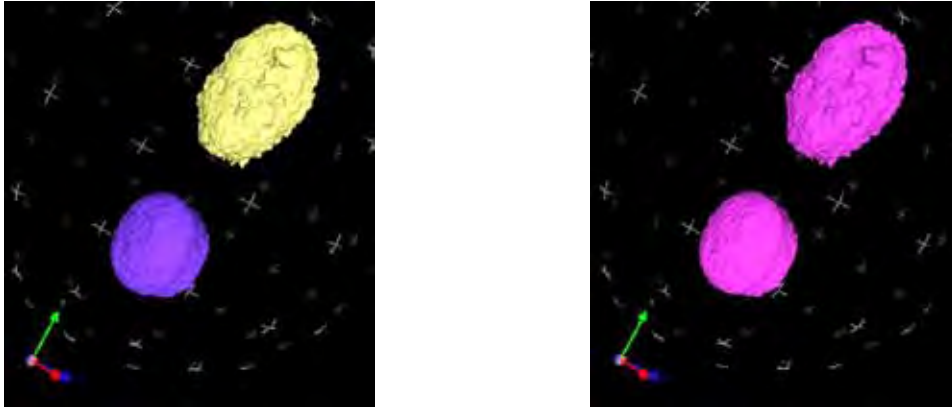

Measured lines can also be joined using this command when two or more lines are selected in the table. The ends of each line which are closest to each other are joined together, creating a single line. This new line is added to the table and re-measured. Again, the previously selected lines are not deleted or altered.

Finally tracks can also be joined, but only under certain circumstances. Two tracks which track an object through the same timepoint cannot be joined. For example: if Track A tracks an object from timepoint 1 to timepoint 5, and Track B tracks an object from timepoint 5 to timepoint 9, the tracks **cannot** be joined, as they both track an object through timepoint 5.

If Track C tracks an object from timepoint 1 to timepoint 4, then it can be joined with Track B. The tracks do not share a timepoint. If the tracks selected cannot be joined, the command will be disabled in the Measurements menu. Any number of tracks can be joined, providing that no two selected tracks share a timepoint.

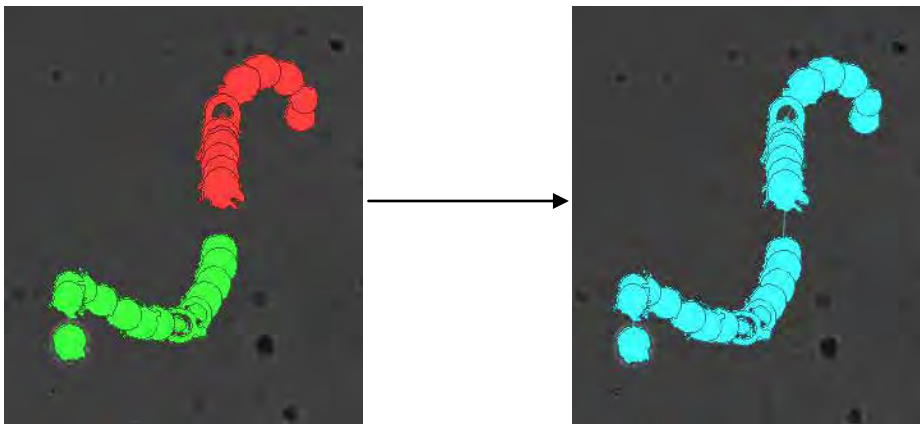

When two or more tracks are joined, a new track is created in the Tracking table. This track is assigned a new Tracking ID, and is re-measured for length, velocity, etc. All objects which were previously associated with the selected tracks are now only associated with the new track, and their tracking IDs will all be reassigned to the new track.

Note that this does not delete or alter the tracks previously selected; however the objects previously associated with them will now be associated with the new track instead.

Exporting Measurements

Once you have created a Measurements table, you can also export the measurements. Select **Export** from the File menu and select the required file format.

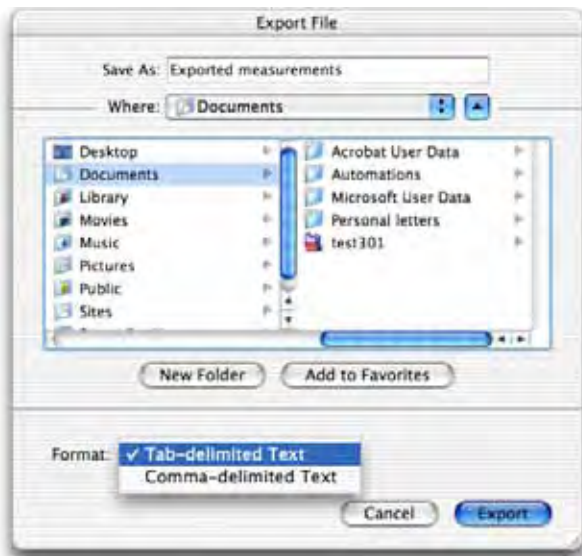

Feedback from the Raw View

If a row in the Raw View of a Measurement Item corresponds to a single measured object, its location in the original image data can be shown using feedback. When the row is selected the object will be shown using colored feedback in any open Image, Measurements or 3D View (if available) of the data from which that measurement was made.

Select measurements in a view by clicking on a row, shift and click to select multiple rows.

Open the corresponding image data, usually an image sequence, and the feedback will be shown.

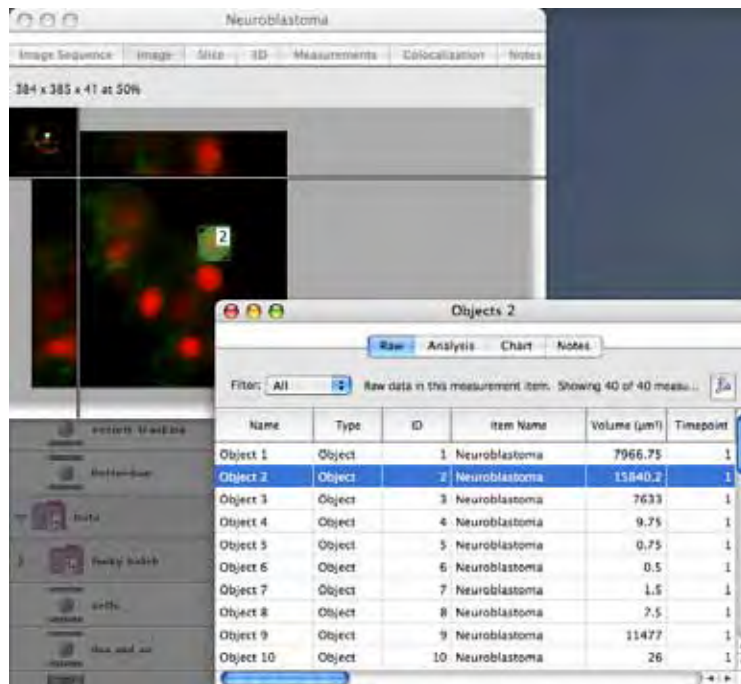

To control how feedback is displayed:

- n Use the **Feedback Options...** command in the Measurements menu to define the feedback display.
- n Use the **Change Object Colors...** command in the Raw menu to define the color of object feedback.

Feedback Options Dialog

The Feedback Options dialog is tabbed, with one tab for each type of measurement object that may be present in the table. The types available vary with different software products in the Velocity family.

Each option changes how the feedback will be shown in views of the original data that support feedback display.



Use these options to change how the feedback appears:

- n **Show in current timepoint only** is an option for viewing feedback within time resolved data. When this option is checked only feedback that relates to measurements made from the current timepoint will be shown. Changing the timepoint using the time navigation controls will change the feedback so that only objects in the new timepoint are shown.
- n **Show measurement** will allow any of the measured parameters to be shown alongside the colored shape that represents the measurement.

Note: Some options do not take effect for feedback shown in 3D views. All feedback in 3D views is shown as solid isosurfaces.

Change Object Colors

This dialog changes the color used to represent the selected objects with this dialog.

When **Rainbow colors** is applied, all selected objects or tracks will be colored according to their position in the table. Objects at the top of the table will be colored red; objects further down the table will step down through the visible spectrum, with objects at the bottom colored violet.

This feature can be used to color objects according to any attribute measured by Volocity. The following example colors objects according to their measured volume.

1. Click on the header at the top of the **Volume** column to order all objects in the table by their measured volume.
2. Select all the objects in the table that you wish to recolor and select **Change Object Colors...** in the Measurements menu.
3. Select **Use Rainbow Colors** and click OK.

The color coding on the measurements feedback in the other views now reflects the objects' measured volume.

If Feedback is not Displayed

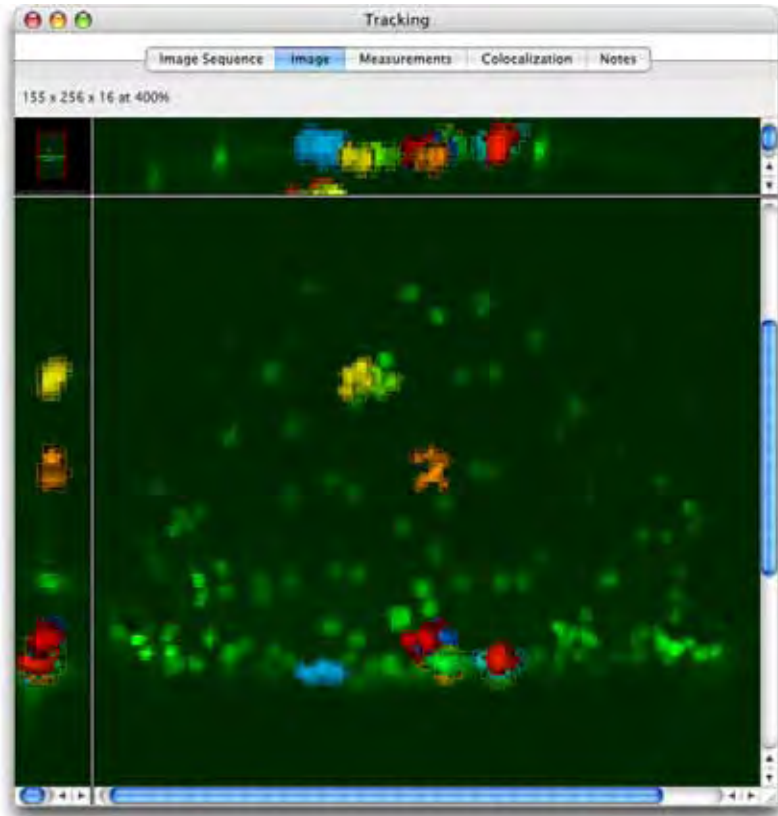

If Feedback is not Displayed

If feedback is not displayed as expected, check the item name column for the selected measurements. The correct image data must be open.

Check the **Feedback Options** dialog to check that the feedback is prominent enough against the image data.

Check the status of **Show objects in current timepoint only**. Use the Time Navigation controls to move to the correct timepoint or uncheck this option to show all objects regardless of the timepoint in which the object was measured.

Measurement Definitions

To obtain measurements it may be necessary to add the relevant task to the measurement protocol. To display measurements it may be necessary to change the columns that are displayed. Select **Columns...** from the Measurements or Raw menu.

These measurements may be shown for any measurement type

Name	Name of the measurement
Type	Object, line, point or track
ID	Unique identifying number for this measurement.
Color	Color used to display this measurement in feedback.
Item Name	Shown in Measurement items only. Records the name of the image or image sequence from which the measurements were derived.
Timepoint	An indication of where in the time course of the image sequence the measurement came from. Timepoints start at 1. Shown only when multiple timepoints are measured.
Abs. Time	Current time when the image (2D or 3D) was captured.
Rel. Time	Relative time for the image, the first timepoint is time 0:00.

The following measurements may be made or derived for objects measured.

Parent ID	Given to an object when a measurement operation is performed that relates that object to another. The parent ID is the unique ID for the associated object. Relate objects to the parent they are associated with by organising by parent ID.
Track ID	Given to an object when the track objects task determines it to be part of a track. The track ID reflects the unique ID for the track. Relate objects to their track by organising by track ID.
Voxel Count	Number of voxels which make up an object in 3D dataset.
Volume (μm^3)	Calibrated volume.

Measurement Definitions

Surface Area (μm^2)	Total area of triangles fitted to the surface voxels of the data set.
Skeletal length	This is the maximum length of the object. The selection is eroded evenly from its border inwards until it consists of a one-voxel thick, skeletal representation along its entire length. This "skeleton" is then measured.
Skeletal diameter	The diameter of a cylinder if it had a length equal to the skeletal length of the object and a volume equal to the object's measured volume.
Pixel Count	Number of pixels which make up an object in 2D dataset.
Area (μm^2)	Calibrated area.
Perimeter	Length of the boundary of the object.
Min	May be followed by channel name in brackets. Minimum intensity in gray levels.
Max	May be followed by channel name in brackets. Maximum intensity in gray levels.
Mean	May be followed by channel name in brackets. Mean intensity in gray levels.
Sum	May be followed by channel name in brackets. Sum of intensity in gray levels.
Standard Deviation	May be followed by channel name in brackets. Standard deviation of intensity in gray levels.
Min (ignoring zero values)	Must be specified by a Measure Objects task. Will show minimum grayscale intensity value ignoring any 0 values.
Max (ignoring zero values)	Must be specified by a Measure Objects task. Will show maximum grayscale intensity value ignoring any 0 values.
Mean	Must be specified by a Measure Objects task. Will show mean grayscale

(ignoring zero values)	intensity value ignoring any 0 values.
Sum (ignoring zero values)	Must be specified by a Measure Objects task. Will show sum of grayscale intensity value ignoring any 0 values.
Centroid X	Position of object centroid in X axis
Centroid Y	Position of object centroid in Y axis
Centroid Z	Position of object centroid in Z axis
Centroid X (µm)	Calibrated position of object centroid in X axis.
Centroid Y (µm)	Calibrated position of object centroid in Y axis.
Centroid Z (µm)	Calibrated position of object centroid in Z axis.
Velocity	Measurement added by tracking. Speed of movement between previous timepoint and current timepoint.
Velocity (µm/s)	Calibrated velocity.
Distance	Measurement added by tracking. Distance moved by this object between previous timepoint and current timepoint.
Distance (µm)	Calibrated distance.
Delta ²	Displacement squared. The square of the straightline distance between the object position in this timepoint and the object position in the first timepoint.
Delta ² (µm)	Calibrated displacement squared. Use with analysis tools to calculate mean square displacement for all objects with the same track ID.

Measurement Definitions

Angle (degrees)	Calculated for tracked objects only. A measure of the spatial relationship between the vector of the straight line displacement between this point and the start point of the track and the vector 0,-1,0 (up). The angle of the shortest distance between these two vectors. Ranges from 0 to 180. 0 means pointing "up the screen", along the Y axis. 180 means pointing "down" the screen.
Bearing (degrees)	Calculated for tracked objects only. A measure of the spatial relationship between the vector of the straight line displacement between this point and the start point of the track and the vector 0,-1,0 (up). The angle disregarding the Z component. Ranges from 0 to 360. 90 means pointing "right", along the X axis. 270 means pointing "left", negatively along the X axis.
Elevation (degrees)	Calculated for tracked objects only. A measure of the spatial relationship between the vector of the straight line displacement between this point and the start point of the track and the vector 0,-1,0 (up). The angle in relation to the XY plane. Ranges from -90 to 90. -90 means straight down paraleel to the Z axis, 0 means parallel to the XY plane, 90 means up, parallel to the Z axis.

The following measurements may be made or derived for tracks

Length	Total length of the track in pixels.
Length (μm)	Calibrated length of the track.
Time span	Number of timepoints over which the track extends.
Track velocity	Average speed over the whole track.
Track velocity ($\mu\text{m/s}$)	Calibrated average speed over the track.
Displacement	Straight line distance from the first position in the track to the last.
Displacement (μm)	Calibrated displacement.
Displacement rate	Displacement/(time of the last time point in the track – time of the first time point in the track)

Displacement rate ($\mu\text{m/s}$)	Calibrated displacement rate.
Meandering index	This is the displacement rate / velocity, which provides a measure of a track's deviation from a straight line. The meandering index is always a value less than or equal to 1. A meandering index of 1 indicates that the track is a perfect straight line; the smaller the value of the meandering index, the greater the meandering of the track.
Angle (degrees)	A measure of the spatial relationship between the vector of the displacement of the track and the vector 0,-1,0 (up). The angle of the shortest distance between these two vectors. Ranges from 0 to 180. 0 means pointing "up the screen", along the Y axis. 180 means pointing "down" the screen.
Bearing (degrees)	A measure of the spatial relationship between the vector of the displacement of the track and the vector 0,-1,0 (up). The angle disregarding the Z component. Ranges from 0 to 360. 90 means pointing "right", along the X axis. 270 means pointing "left", negatively along the X axis.
Elevation (degrees)	A measure of the spatial relationship between the vector of the displacement of the track and the vector 0,-1,0 (up). The angle in relation to the XY plane. Ranges from -90 to 90. -90 means straight down parallel to the Z axis, 0 means parallel to the XY plane, 90 means up, parallel to the Z axis.

The following measurements may be made for lines

Length	Length of the line in pixels.
Length (μm)	Calibrated line length.
Population ID	Group that lines belong to. Lines of the same color have the same population ID.
Start position	Must be specified by a Measure Lines task. Records start position of the line.
End position	Must be specified by a Measure Lines task. Records end position of the line

Measurement Definitions

Start position (μm)	Calibrated start position.
End position (μm)	Calibrated end position.
Parent ID	Specified by a Measure Line Profiles task. The ID number of the line to which the sample point belongs. Relate sample points to the line they are associated with by organizing by parent ID.
Intensity	Specified by a Measure Line Profiles task. The interpolated intensity value at the sample point.
Distance	Distance from the start of the line in pixels.
Distance (μm)	Calibrated distance.
Normalized Distance	Specified by a Measure Line Profiles task. Distance from the start of the line normalized to a total line length of 1.
Channel	Specified by a Measure Line Profiles task. Shown when measuring line profiles on multi channel data sets only. This column contains the name of the channel the intensity measurement was made from. In a multi-channel data set there will be a complete set of sample points for each channel.

The following measurements may be made for points

Position X	Position of the point in X axis.
Position Y	Position of the point in Y axis.
Position Z	Position of the point in Z axis.
Position X (μm)	Calibrated position of the point in X axis.
Position Y (μm)	Calibrated position of the point in Y axis.
Position Z (μm)	Calibrated position of the point in Z axis.

Analysis View

Click on the Analysis tab of a measurement item to work with the data and organize it in different ways. The reorganized data will be shown in this view. Some saved analysis protocols are installed with Volocity, select from the list in the view or click **More protocols...** to see all saved protocols.

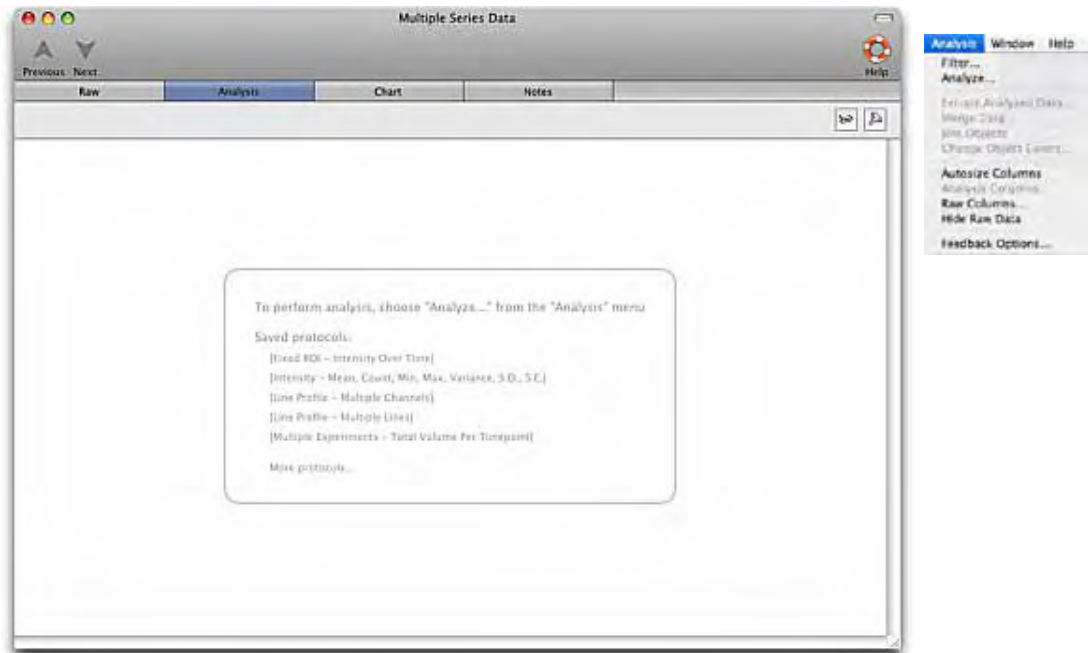

Select **Analyze...** from the Analysis menu to open the dialog that will allow you to perform this powerful organization.



Analyze these data: The drop-down shows all the measured criteria available for the objects in the Raw table, select one as the subject of analysis. If the analysis is to look at intensity over time, select a column containing intensity values. Multiple items may be selected from the list.

Summarized by: Choose from Value, Mean, Sum, Product, Count, Min/Max, Variance/SD. Select multiple summaries if required.

Organize the data by: Select other measured criteria from the raw table to show the relationship between those criteria and the subject of the analysis selected in **Analyze these data:** If the analysis is to look at intensity over time, select the time or timepoint column here.

It is possible to organize the data by up to three criteria, rows, columns and pages.

In the Organization tab **Grouped into bins** will allow you to divide the rows, columns and/or pages into groups to best present the data.

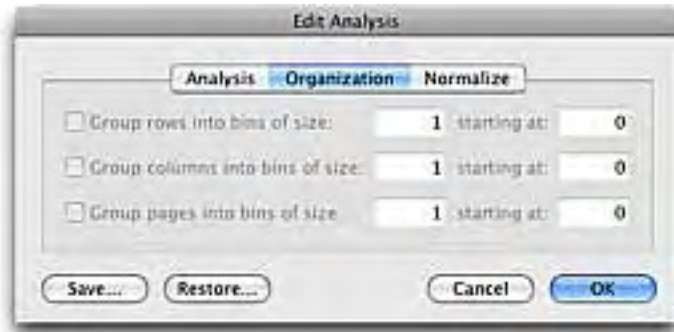

Data filtered out of the Raw View will not be included in analysis but the filter may be edited at any time by selecting **Filter...** from the Analysis menu or clicking on the filter button at the top of the screen.

Normalize

Once the analysis table has been populated it is possible to recalculate values using to be normalized to values in the table. This means all values in all other rows will be recalculated as a proportion of the corresponding value. Select the row or column to normalize to and whether this is to be considered as 100% or 1.

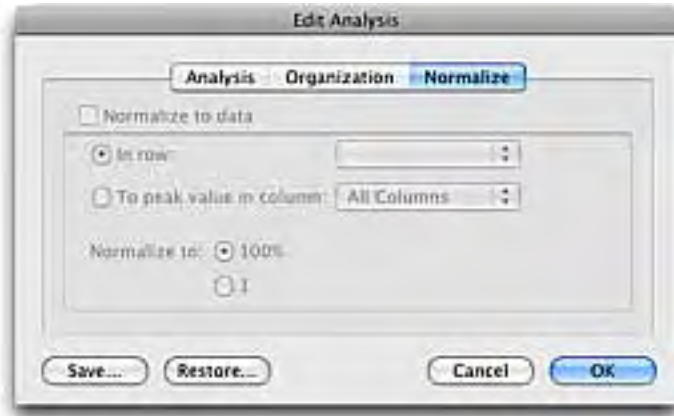

The Analysis menu contains options for working with the analysis table created.



Extract Analyzed Data... creates a new Measurement item containing just the analyzed or reorganized data, which can be analyzed further.

Merge Data... adds the analysis table to an existing measurement item.

Remove duplicate rows ensures that the same measurement is not repeated.

Merge similar rows ensures that different measurement criteria, indicated by the column heading, for the same object are kept in one row, not spread over two or more.

This could be used to combine two or more different analysis methods in one table. The result of one way of organization is extracted to a new measurement item then the original item reorganized and the result merged with the item created in the first step.

Change the appearance of the tables shown in this view by using the options for columns in the Analysis menu.

- n To re-organize columns click the column heading, drag it to its new position and release.
- n To sort columns click on the column heading—an arrow shows that the column is sorted and the direction of the arrow indicates whether the sort order is ascending or descending. Click again to reverse the sort. For example: sort on the Name column to group together the same types of measurement.
- n To change the width of a column click on the cell border and drag.
- n To resize all columns to fit contents, select **Autosize Columns**
- n To hide/show columns select **Analysis** or **Raw Columns...** in the Analysis menu.

Analysis Examples

Find the Total Number of Objects Measured

A measurement item Raw View contains one row of information per object. In the following example a protocol was applied to five image sequences and the table contains over 32000 measurements.

Name	Type	ID	Item Name	Volume (µm ³)	Timepoint	Abs. Time	Rel. Time...
Object 8479	Object	8479	Experiment 1	0.301692	2	14:57:3...	120.948
Object 11701	Object	11701	Experiment 1	0.452538	2	14:57:3...	120.948
Object 13547	Object	13547	Experiment 1	0.50282	2	14:57:3...	120.948
Object 33478	Object	33478	Experiment 1	0.402256	2	14:57:3...	120.948
Object 37416	Object	37416	Experiment 1	0.301692	2	14:57:3...	120.948
Object 41711	Object	41711	Experiment 1	0.402256	2	14:57:3...	120.948
Object 44960	Object	44960	Experiment 1	0.351974	2	14:57:3...	120.948
Object 49385	Object	49385	Experiment 1	0.351974	4	15:01:3...	361.01
Object 65239	Object	65239	Experiment 1	0.301692	4	15:01:3...	361.01
Object 66082	Object	66082	Experiment 1	0.301692	4	15:01:3...	361.01
Object 69193	Object	69193	Experiment 1	0.301692	4	15:01:3...	361.01
Object 69314	Object	69314	Experiment 1	0.301692	4	15:01:3...	361.01
Object 69573	Object	69573	Experiment 1	0.301692	4	15:01:3...	361.01
Object 69837	Object	69837	Experiment 1	0.301692	4	15:01:3...	361.01
Object 79561	Object	79561	Experiment 1	0.301692	4	15:01:3...	361.01
Object 88861	Object	88861	Experiment 1	0.553102	4	15:01:3...	361.01
Object 95418	Object	95418	Experiment 1	0.452538	4	15:01:3...	361.01
Object 96716	Object	96716	Experiment 1	0.301692	4	15:01:3...	361.01
Object 96799	Object	96799	Experiment 1	0.301692	4	15:01:3...	361.01

To find the total number of objects measured in each of the image sequences the Analysis dialog in the Analysis View is configured as follows:

- n Analyze this data: **ID**. Anything that has been measured for each item could be used here.
- n Summarized by: **Count**. The total number of IDs and therefore the total number of objects.
- n Row: **Item Name**. Show the name of the library item to organize the data by image sequence.
- n Column: Not required.
- n Page: Not required.

Analysis Examples



The Analysis View looks like this:

Multiple Series Data

Previous Next Help

Raw Analysis Chart Notes

Count of data from ID, row values from Item Name.

Item Name	Count of ID
Experiment 1	240
Experiment 2	480
Experiment 3	480
Experiment 4	240

The analysis table arranges the data for a chart. This table could be displayed as a bar chart:

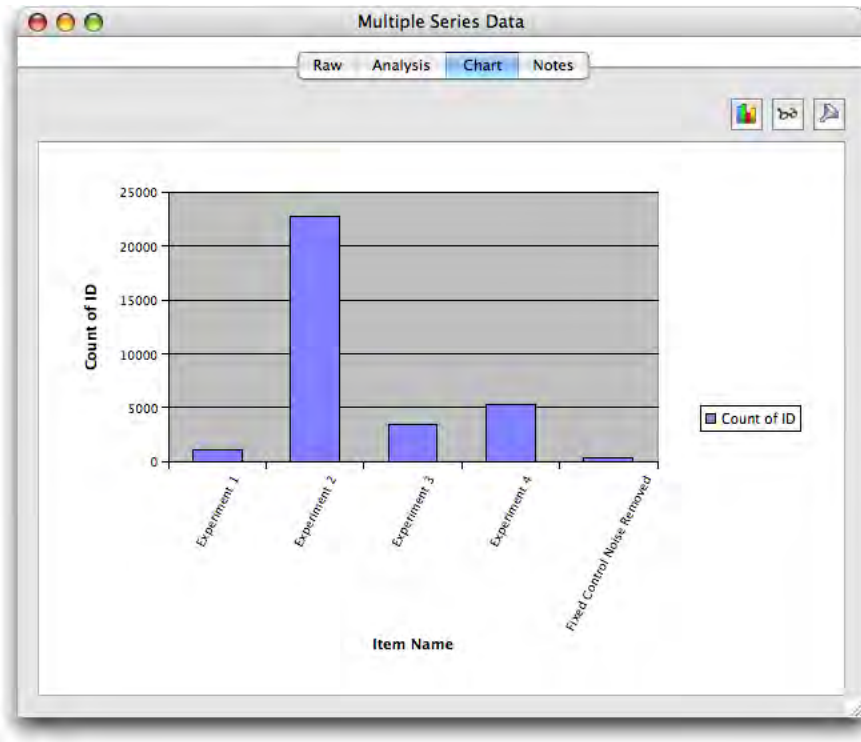

Find the Total Number of Objects Measured per Timepoint

Using the same table of data as the previous example, to find the total number of objects measured per timepoint, the Analysis dialog in the Analysis View is configured as follows:

- n Analyze this data: **ID**. Anything that has been measured for each item could be used here.
- n Summarized by: **Count**. Generate a count of the total number of unique IDs and therefore the total number of objects.
- n Row: **Timepoint**.
- n Column: Not required.
- n Page: Not required.

Analysis Examples



The Analysis View looks like this:

Multiple Series Data

Previous Next Help

Raw Analysis Chart Notes

Count of data from ID, row values from Timepoint.

Timepoint	Count of ID
1	30
2	30
3	30
4	30
5	30
6	30
7	30
8	30
9	30
10	30
11	30
12	30
13	30
14	30
15	30
16	30
17	30
18	30

Find the Mean Intensity of Objects per Timepoint per Image Sequence

Using the same table of data as the previous example, to find out whether there is a pattern to intensities of objects dependent on timepoint and experiment, the Analysis dialog in the Analysis View is configured as follows:

- n Analyze this data: **Mean Intensity**. Where more than one channel has been measured in the data set choose the mean intensity column for the channel of interest.
- n Summarized by: **Mean**. If multiple objects have been measured in every timepoint this will present the mean of the mean intensities.
- n Row: **Timepoint**.
- n Column: **Item Name**. The Item Name is the name of the image sequence so there will be one column for each image sequence measured.
- n Page: Not required.



The Analysis View looks like this:

The screenshot shows a software window titled "Multiple Series Data" with a menu bar (Previous, Next, Help) and a toolbar. The "Analysis" tab is selected, displaying a table with the following data:

Timepoint	Mean of Experiment 1	Mean of Experiment 2	Mean of Experiment 3	Mean of Experiment 4
1	6213.192352	N/A	6213.192352	N/A
2	6032.784796	N/A	6032.784796	N/A
3	6132.372981	N/A	6132.372981	N/A
4	5849.066782	N/A	5849.066782	N/A
5	5716.185633	N/A	5716.185633	N/A
6	5682.164381	N/A	5682.164381	N/A
7	5595.937675	N/A	5595.937675	N/A
8	5535.12123	N/A	5535.12123	N/A
9	5623.295499	N/A	5623.295499	N/A
10	5713.470784	N/A	5713.470784	N/A
11	5817.945162	N/A	5817.945162	N/A
12	5943.978277	N/A	5943.978277	N/A
13	5853.649062	N/A	5853.649062	N/A
14	5832.926058	N/A	5832.926058	N/A
15	5746.266616	N/A	5746.266616	N/A
16	5665.018795	N/A	5665.018795	N/A
17	5526.281099	N/A	5526.281099	N/A

Mean Number of Objects per Cell

Objects have been measured to identify those that are within measured cells. Objects have been given a Parent ID according to the objects they are found within, using **Internalize Measured Objects** in a measurement protocol.

Max	Mean	Sum	Voxel Co...	Centroid Z	Centroid ...	Surface A...	Surface A...	Parent ID
689	157.428	423167	2688	4.37426	2.18713	3104.97	439.47	N/A
129	117.5	470	4	0.75	0.375	12.6087	1.76684	N/A
123	115.6	578	5	0	0	14.5605	1.8589	2
113	113	226	2	0	0	10	1.35361	2
348	184.74	19213	104	3.98077	1.99038	146.235	21.9458	4
348	158.976	113191	712	5.18539	2.5927	829.29	120.715	2
121	121	121	1	0	0	6	0.835365	N/A
140	122	1220	10	0.6	0.3	27.6814	3.98682	2
199	142.824	2428	17	0.411765	0.205882	44.4364	6.02348	2
132	126.25	505	4	0	0	16	2.07299	1
112	111.5	223	2	0.5	0.25	10	1.4696	2
129	126	252	2	0	0	10	1.35361	2
121	121	121	1	0	0	6	0.835365	2
110	110	110	1	0	0	6	0.835365	2
144	130.4	652	5	0.4	0.2	13.5123	1.95419	2
116	116	116	1	0	0	6	0.835365	1
152	123.833	2972	24	1.45833	0.729167	52.0475	7.51267	N/A
109	109	109	1	0	0	6	0.835365	2
191	147.938	2367	16	0.75	0.375	34.853	4.96071	N/A

To find out how many objects are within each of the larger objects, the analysis dialog is configured as follows:

- n Analyze this data: **ID**. Anything that has been measured for each item could be used here.
- n Summarized by: **Count**. The total number of IDs and therefore the total number of objects.
- n Row: **Parent ID**. Organize the objects by the ID of the object they were found within.
- n Column: Not required.
- n Page: Not required.

Analysis Examples



The Analysis View looks like this:

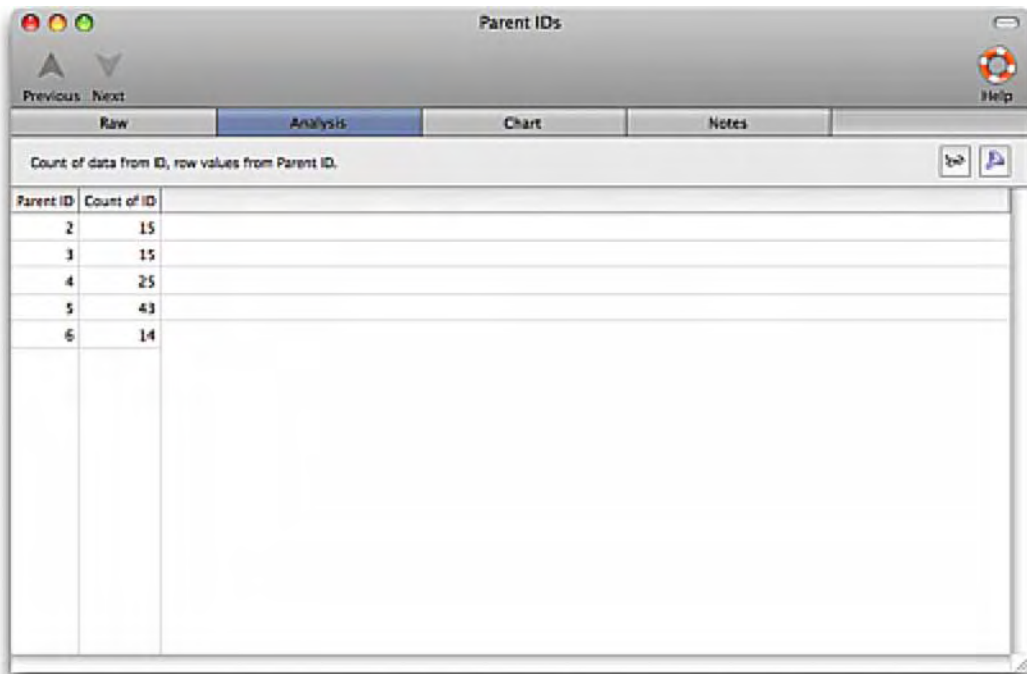

Chart Line Profiles

The Measure Line Profiles task creates a data table consisting of intensity measurements for each sample point along each line.

In this example one line has been measured on a three channel dataset.

Name	Ab...	Color	Distance	Distance (µm)	Intensity	Parent ID	Populatio...	Total
Line 1	21...	N/A	N/A	N/A	N/A	N/A	1	15
Profile Sample 1 for Line 1	21...		0	0	4	1	N/A	N/A
Profile Sample 2 for Line 1	21...		1	0.148	3.94879	1	N/A	N/A
Profile Sample 3 for Line 1	21...		2	0.296	3.89758	1	N/A	N/A
Profile Sample 4 for Line 1	21...		3	0.444	3.84637	1	N/A	N/A
Profile Sample 5 for Line 1	21...		4	0.592	3.79517	1	N/A	N/A
Profile Sample 6 for Line 1	21...		5	0.74	3.74396	1	N/A	N/A
Profile Sample 7 for Line 1	21...		6	0.888	3.69275	1	N/A	N/A
Profile Sample 8 for Line 1	21...		7	1.036	3.64154	1	N/A	N/A
Profile Sample 9 for Line 1	21...		8	1.184	3.59033	1	N/A	N/A
Profile Sample 10 for Line 1	21...		9	1.332	3.53912	1	N/A	N/A
Profile Sample 11 for Line 1	21...		10	1.48	3.48792	1	N/A	N/A
Profile Sample 12 for Line 1	21...		11	1.628	3.43671	1	N/A	N/A
Profile Sample 13 for Line 1	21...		12	1.776	3.3855	1	N/A	N/A
Profile Sample 14 for Line 1	21...		13	1.924	3.33429	1	N/A	N/A
Profile Sample 15 for Line 1	21...		14	2.072	2.57933	1	N/A	N/A
Profile Sample 16 for Line 1	21...		15	2.22	3.21675	1	N/A	N/A

In the analysis we wish to see the intensity at each distance from the origin of the line in each of the three channels. This example is available in the saved protocols. The analysis dialog is configured:

- n Analyze these data: Intensity
- n Summarized by: Value
- n Row: Distance
- n Column: Channel

This creates an analysis table which may be charted as below:

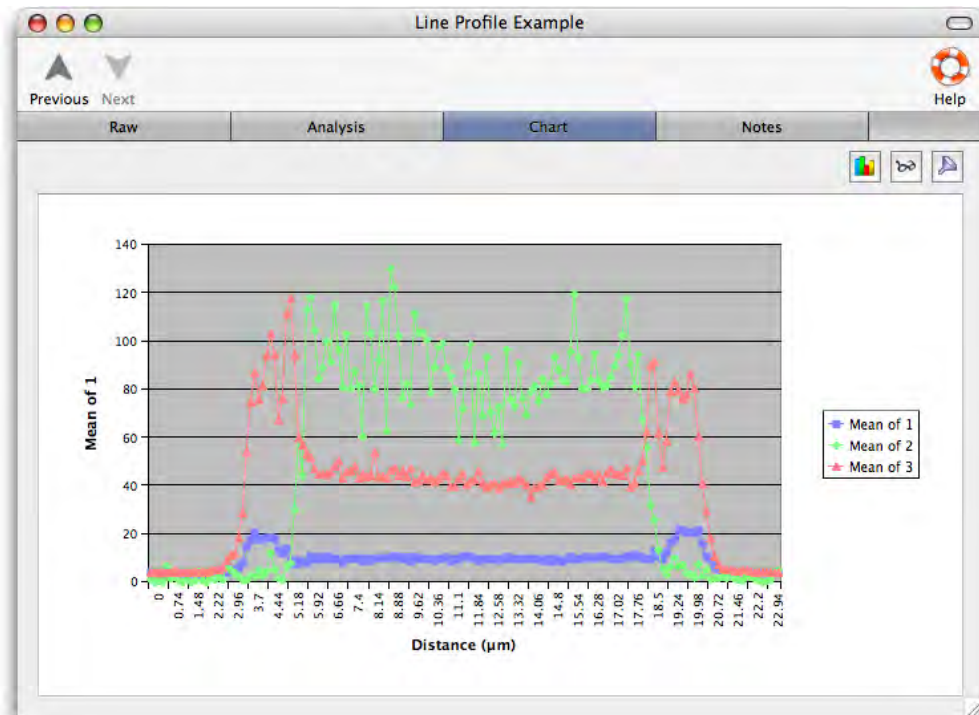

If multiple lines had been drawn displaying the profile for all the lines on the same chart would be achieved by configuring the analysis dialog as:

- n Analyze these data: Intensity
- n Summarized by: Value
- n Row: Distance
- n Column: Parent ID

If multiple channels are present in the data the profiles for all the lines could be compared per channel by setting Page: Channel or display all channels for each line on a separate page in which case Column: Channel and Page: Parent ID.

Show Changes in Intensity with Object Volume

- n Analyze this data: **Mean**. For a single channel data set this represents the mean intensity of each object.
- n Summarized by: **Mean**
- n Row: **Volume**. Since there are many volumes represented in the table, showing each one individually will be excessive data to process. Rows, Columns and Pages may all be shown grouped into bins to prepare data in the style of a histogram. In the Organization tab group rows into bins, using a size appropriate for the data distribution.
- n Column: Not required.
- n Page: Not required.



Show Changes in Object Velocity over Time

Track objects using a measurement protocol containing the Track Objects task. An example is included in the saved protocols installed with Velocity. Object tracking measures not only an average Velocity for the whole track, shown in the Raw View in the Track Velocity column but also each object velocity from one timepoint to another. These velocities may be analyzed to illustrate the nature of the object movement over the time course of the experiment. This example is also included in the saved analysis protocols.

Name	Type	ID	Item Name	Volume (µm³)	Timepoint	Abs. Time	Rel. Time...
Object 23	Object	23	vesicle tracking	83	1	17:22:0...	0
Object 24	Object	24	vesicle tracking	87	1	17:22:0...	0
Object 25	Object	25	vesicle tracking	96	1	17:22:0...	0
Object 26	Object	26	vesicle tracking	78	1	17:22:0...	0
Object 27	Object	27	vesicle tracking	83	1	17:22:0...	0
Object 28	Object	28	vesicle tracking	142	1	17:22:0...	0
Object 29	Object	29	vesicle tracking	99	1	17:22:0...	0
Object 30	Object	30	vesicle tracking	53	1	17:22:0...	0
Object 31	Object	31	vesicle tracking	177	1	17:22:0...	0
Object 32	Object	32	vesicle tracking	81	1	17:22:0...	0
Object 33	Object	33	vesicle tracking	63	1	17:22:0...	0
Object 34	Object	34	vesicle tracking	195	1	17:22:0...	0
Object 35	Object	35	vesicle tracking	140	1	17:22:0...	0
Object 36	Object	36	vesicle tracking	227	1	17:22:0...	0
Object 37	Object	37	vesicle tracking	79	1	17:22:0...	0
Object 38	Object	38	vesicle tracking	1	1	17:22:0...	0
Object 39	Object	39	vesicle tracking	35	1	17:22:0...	0
Object 40	Object	40	vesicle tracking	60	1	17:22:0...	0
Object 41	Object	41	vesicle tracking	30	1	17:22:0...	0

The Analysis dialog is configured as follows:

- n Analyze this data: **Velocity**.
- n Summarized by: **Value**.
- n Row: **Relative Time**. Time may be absolute, relative or by timepoint.
- n Column: **Track ID**. All the objects that make up a track are related to each other by the Track ID.

n Page: Not required.



Analysis Examples

This could be illustrated in a line chart. The following chart indicates that the objects accelerate and decelerate throughout the experiment.

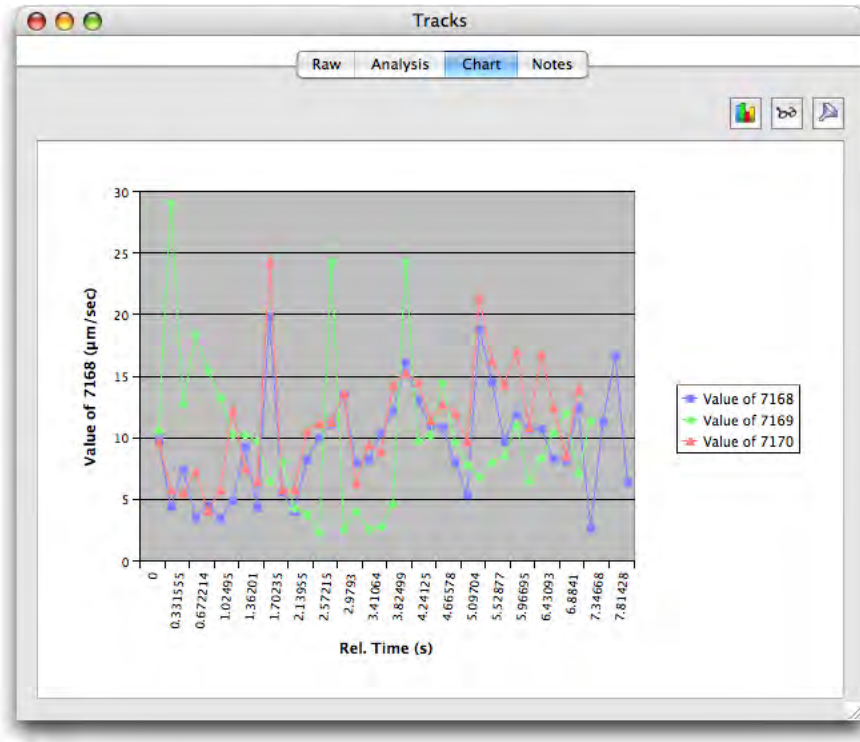

Chart View

The Chart View shows a graphical representation of the data in the analysis table. To generate a chart:

- n First, set up an analysis table in the Analysis View.

- n Then click on the Chart tab.

To configure chart style and appearance select **Chart...** from the Chart menu or click on the chart button at the top right of the window.

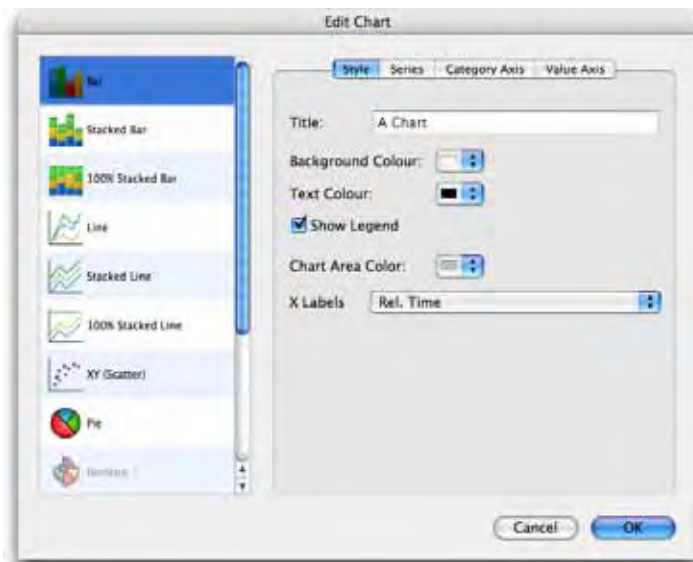

The chart will show only data that is not filtered out. Edit the filter from the Chart View by selecting **Filter...** from the Chart menu or clicking on the filter button at the top right of the window.

The Analysis table which is being represented in the chart can also be changed without returning to the Analysis tab. Choose **Analyze...** from the Chart menu or click on the analyze button at the top right of the window.

Exceptions to this description are the Track Charts. These are examples of special case charts where the information required to generate them is extracted directly from the raw data in the Raw View. When working with tracks click directly on the Chart tab to view XY or XYZ Tracking Charts

Chart View

Available chart types are:

- n Bar - compare values across categories
- n Stacked Bar - compare contribution of a value to the total across categories
- n 100% Stacked Bar - compare percentage contribution across categories
- n Line - display trend across categories
- n Stacked Line - display trend of contributions to the total across categories
- n 100% Stacked Line - display trend of percentage contributions across categories.
- n XY (Scatter) - compare pairs of values
- n Pie - display contribution of each value to total
- n Horizon - compare values
- n XY Track - display XY positions over time
- n XYZ Track - display XYZ positions over time

To keep an image of the chart select **Capture Snapshot** from the Chart menu. A 2D image of the chart will be added to the library. This may be exported in any of the formats for 2D images.

Chart Examples

For each chart type configuration options are offered for style, series, category axis and value axis.

Style: A wide range of styles is available and each style has a number of user configurable options. The following examples illustrates options for a bar chart.

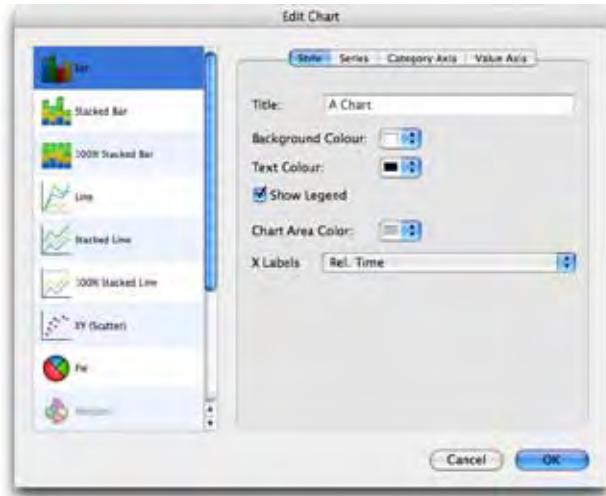

Series: To change the series style, select **Series** from the Edit Chart dialog. Color and pattern may be changed, as required.

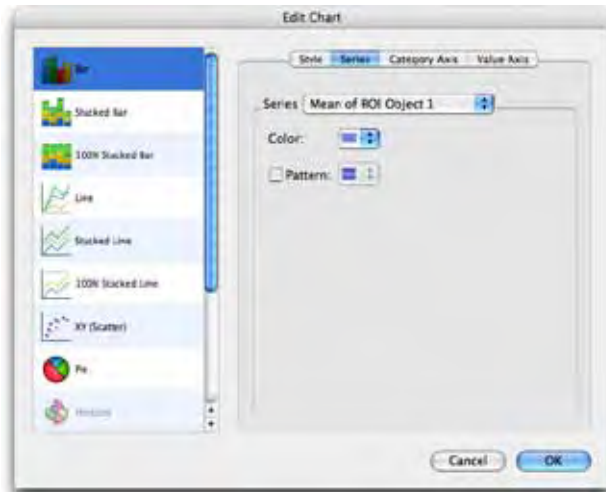

Category Axis: To change the categories, select **Category Axis** from the Edit Chart dialog. Axis scale limits and divisions may be changed, as required.

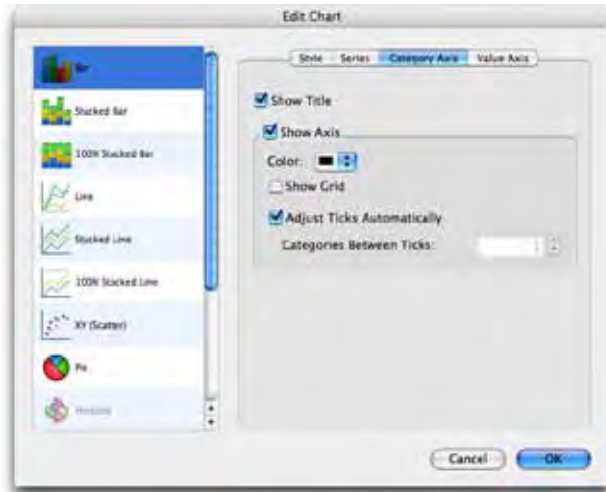

Value axis: To change the categories, select **Category Axis** from the Edit Chart dialog. Axis scale limits and divisions may be changed as required.



Colocalization

Colocalization is part of the Volocity Quantitation product designed specifically for Colocalization analysis as described by Manders et al (1993).

Colocalization in the context of digital fluorescence imaging can be described as the detection of signal at the same voxel location in each of two channels. The two channels are made up of images of two different fluorochromes taken from the same sample area.

Colocalization calculates measurement statistics based on the voxels and their intensity. It provides the user with a tool for evaluating how similar the images from two channels are. It provides a separate Colocalization view that shows:

- n An extended focus merge of the two channels as a preview
- n A scatter plot that represents the intensity values found within the images
- n Statistics, which consist of Pearson's Correlation and Overlap Coefficients Colocalization Coefficients
- n Any thresholds that have been applied to the data

The Colocalization View has a view specific menu. Commands in this menu are specific to the view.

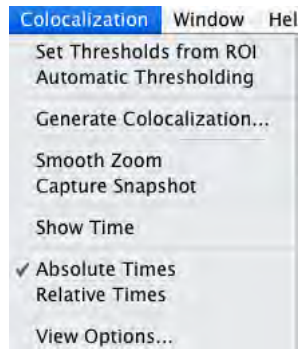

Colocalization menu

The Colocalization View

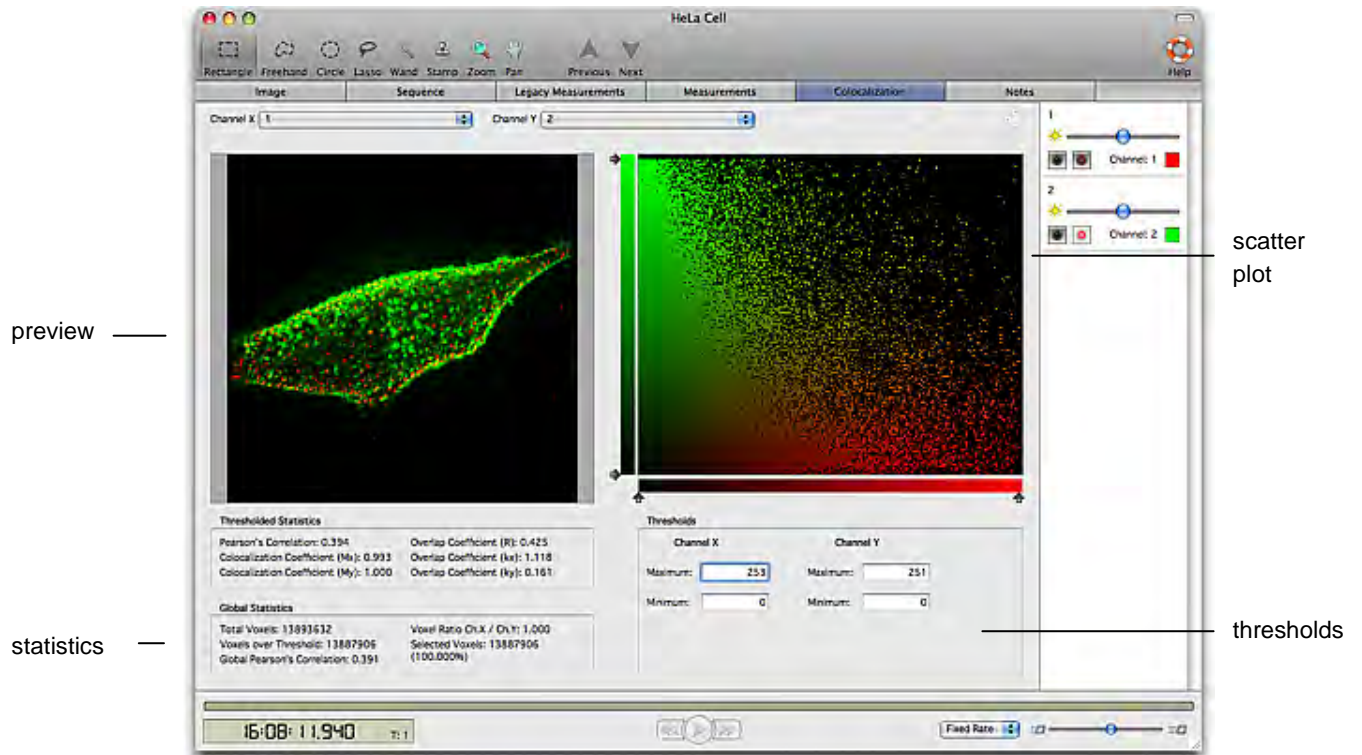

Preview

This is an extended focus merge of the two channels selected in the Channel X and Channel Y drop-downs. The current timepoint is shown and controlled by the time navigation controls.

Show the absolute or relative timestamp of the current timepoint in the preview by selecting **Show Time** from the Colocalization menu.

The following tools from the tool bar may be used on the preview image: rectangular, freehand, circular, magic wand and lasso ROI tools, zoom and pan.

Colocalized voxels selected in the scatter plot are shown using colored feedback in the preview. Use **View Options...** in the Colocalization menu to change the color and opacity of this feedback.

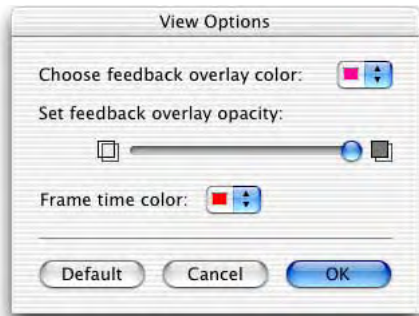

Scatter Plot

Each axis represents the ascending gray levels present within the two analyzed volumes. The axis is assigned according to the drop-downs at the top of the view.

For example: if a voxel in image x has an intensity value of 100 and the corresponding voxel in image y has an intensity value of 30, a point will be plotted at co-ordinates 100,30. It does not matter how many voxels in the two channels have intensity values of 100,30; only one point will be plotted on the scatter plot.

Colocalization

Two perfectly colocalized images, i.e. identical, will generate a scatter plot where the points fall in a line at 45 degrees to either axis.

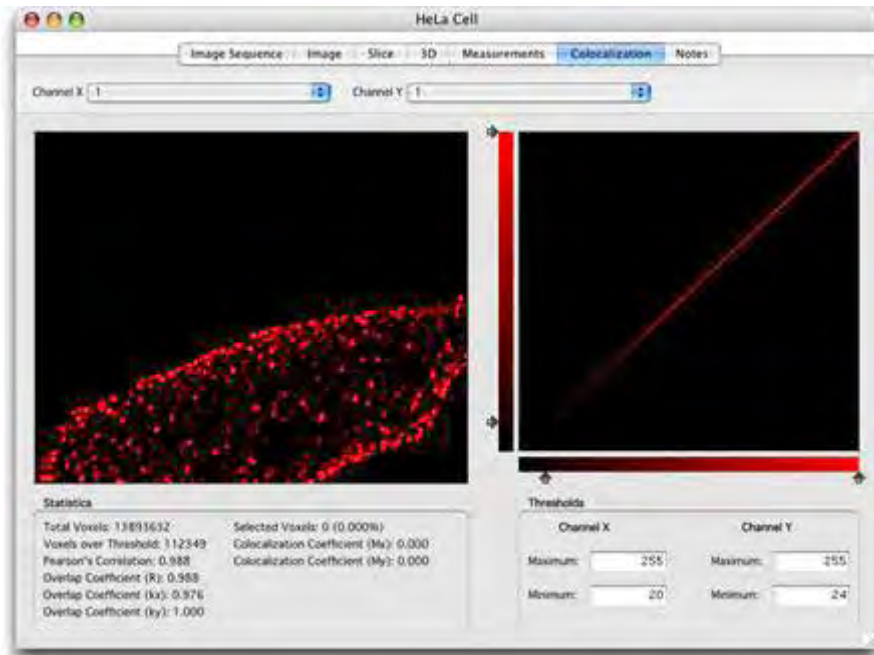

Thresholds

There are three ways of setting thresholds:

- n Use the ROI tool to draw a region of interest on the Preview. Select **Set Thresholds from ROI** from the Colocalization menu. Velocity calculates the mean intensity of the ROI for each channel and sets it as the minimum threshold value for that channel.

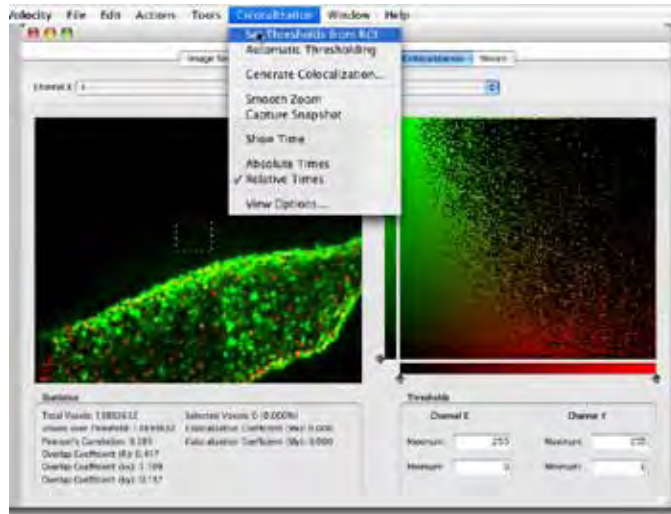

- n Enter the required values manually into the Threshold **Maximum** and **Minimum** boxes for each channel or drag the slider controls on the scatter plot. You will be able to see where voxels have been excluded on the scatter plot. As the thresholds are set voxels outside the threshold are excluded from the image preview on the left. Set thresholds carefully so that background voxels are excluded, leaving only voxels that include genuine signal.

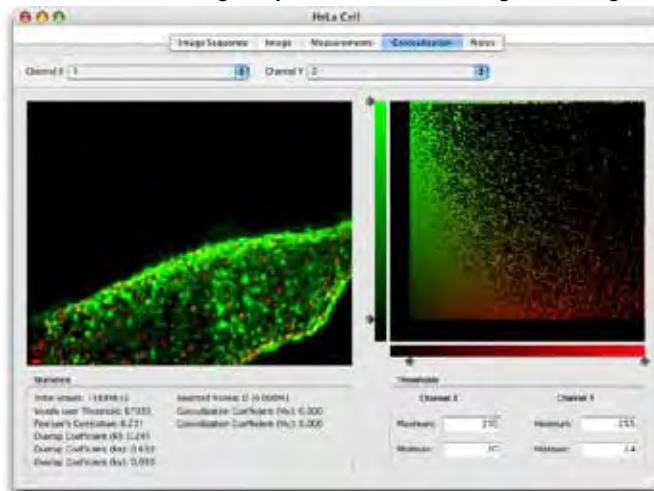

- n Select **Automatic Thresholding** from the Colocalization menu to generate thresholds automatically. Volocity uses statistical tests to set thresholds objectively. Automatically calculating thresholds will take time, and this time will increase with increasing dimensions of the data set. Turning automatic thresholding on disables manual setting of thresholds and **Set thresholds from ROI**. For multi-timepoint data sets, Volocity will recalculate thresholds for each timepoint viewed. Change the current timepoint using the Navigation controls at the bottom of the view.

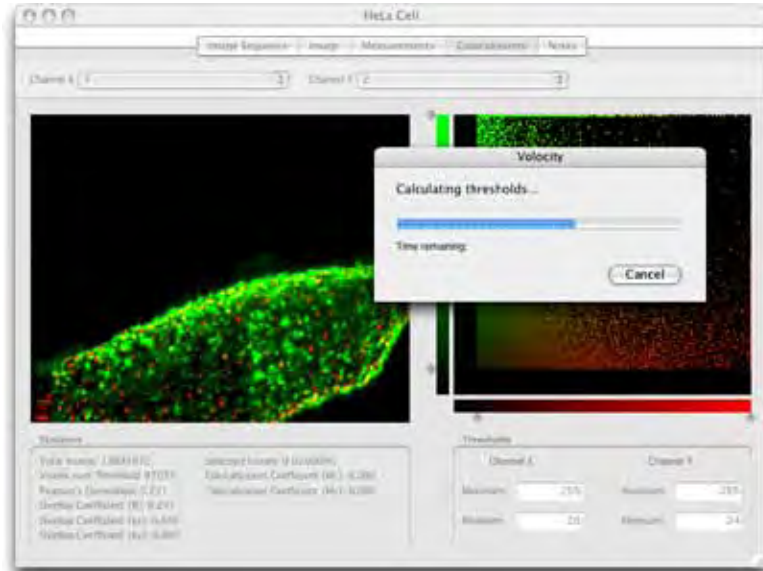

Any voxels of intensity outside threshold will be removed from the preview image for that channel. Any point on the scatter plot that is outside threshold for either channel will be removed from the scatter plot leaving only points that are positive for both x and y, i.e. colocalized.

If thresholds are not set, voxels where both images show background intensity levels will contribute to the generation of colocalization statistics, this may make your channels appear to have a better correlation coefficient than is actually the case.

Automatic Thresholding

The aim of the Automatic Thresholding is to determine thresholds that exclude voxels for which Pearson's Correlation between the two channels is less than, or equal to, 0. It is a two-step process. First, a best-fit regression line of the Channel X and Channel Y intensities over all the voxels is found. Second, the thresholds are moved along the regression line until the point is reached where Pearson's Correlation for voxels below threshold is less than, or equal to, 0. This technique is based on the method proposed in:

S. V. Costes, D. Daelemans, E. H. Cho, Z. Dobbin, G. Pavlakis & S. Lockett

Automatic and Quantitative Measurement of Protein-Protein Colocalization in Live Cells

Biophysical Journal 2004 Vol. 86, pp. 3339-4003

Automatic Thresholding is turned on or off by selecting **Automatic Thresholding** from the Colocalization menu. It is possible that Automatic Thresholding may not be able to determine thresholds for a data set, in which case a message is shown. Automatic Thresholding may determine different thresholds depending on the data set; therefore, it should not be used if the same thresholds are to be applied across a series of data sets or timepoints within the same data set.

Any voxels of intensity outside threshold will be removed from the preview image for that channel. Any point on the scatter plot that is outside threshold for either channel will be removed from the scatter plot leaving only points that are positive for both x and y, that is colocalized.

If thresholds are not set, voxels where both images show background intensity levels may be interpreted as colocalized.

Restricting Analysis to Regions of Interest

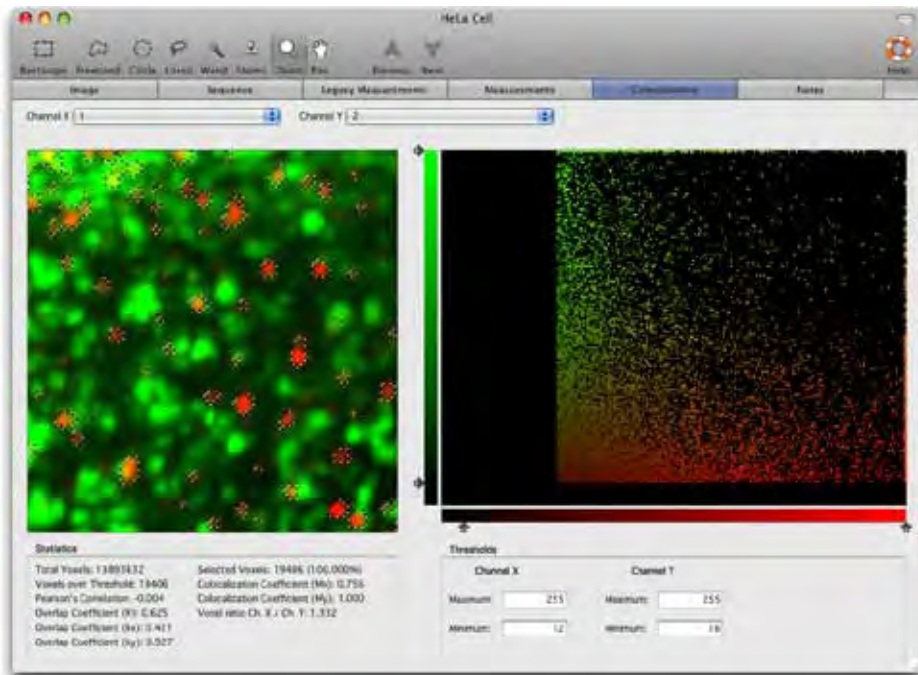

An ROI, or multiple ROIs can be drawn on the preview. When ROIs are present the statistics generated will be based on only those voxels that are both within the ROI and within the thresholds. This allows you to compare different cells or structures within your image sequence. When multiple objects are selected the statistics and scatter plot will represent the voxels from all objects combined.

Statistics

While Volocity is generating the scatter plot and calculating statistics a progress indicator is shown in the top right-hand corner of the view.

The statistics presented in the Colocalization window are calculated as follows:

Thresholded Statistics

Statistics calculated only from intensity values within thresholds. In the case of Pearson's Correlation this allows more reliable interpretation of values..

X_i = intensity of voxel i in image x if X_i is within thresholds.

Y_i = intensity of voxel i in image y if Y_i is within thresholds.

X_{aver} = mean of intensity of voxels within thresholds for image x .

Y_{aver} = mean of intensity of voxels within thresholds for image y .

Intensity values outside threshold ranges are ignored.

$$\text{Pearson's Correlation} = \frac{\sum_i (x_i - x_{aver}) \cdot (y_i - y_{aver})}{\sqrt{\sum_i (x_i - x_{aver})^2 \cdot \sum_i (y_i - y_{aver})^2}}$$

$$\text{Overlap Coefficient (R)} = \frac{\sum_i x_i \cdot y_i}{\sqrt{\sum_i (x_i)^2 \cdot \sum_i (y_i)^2}}$$

The overlap coefficient (R) will give a result between 0 and 1. The use of this coefficient may be limited because it assumes the number of pixels within thresholds in both channels are the same.

$$\text{Overlap Coefficient (kx)} = \frac{\sum_i x_i \cdot y_i}{\sum_i (x_i)^2}$$

$$\text{Overlap Coefficient (ky)} = \frac{\sum_i x_i \cdot y_i}{\sum_i (y_i)^2}$$

Each of the split overlap coefficients is sensitive to variation in intensity of the other channel.

Manders et al. defined two further overlap coefficients:

$$\text{Colocalization Coefficient (Mx)} = \frac{\sum_i x_{i,\text{coloc}}}{\sum_i x_i}$$

$$\text{Colocalization Coefficient (My)} = \frac{\sum_i y_{i,\text{coloc}}}{\sum_i y_i}$$

Where $x_{i,\text{coloc}} = x_i$ if y_i is within the intensity range defined by the ROI, $x_{i,\text{coloc}} = 0$ if y_i is outside the intensity range and $y_{i,\text{coloc}} = y_i$ if x_i is within the intensity range defined by the ROI, $y_{i,\text{coloc}} = 0$, if x_i is outside the intensity range.

Colocalization Coefficients may be values between 0 and 1. 0 indicates that none of the signal within thresholds in that channel exists as colocalized with the other channel. A value of 1 indicates that all of the signal within thresholds in that channel exists as colocalized with the other channel.

Global Statistics

X_i = intensity of voxel i in image unless X_i is outside threshold in which case $X_i = 0$

Y_i = intensity of voxel i in image y unless Y_i is outside threshold in which case $Y_i = 0$

$$\text{Pearson's Correlation} = \frac{\sum_i (x_i - x_{\text{aver}}) \cdot (y_i - y_{\text{aver}})}{\sqrt{\sum_i (x_i - x_{\text{aver}})^2 \cdot (y_i - y_{\text{aver}})^2}}$$

Pearson's Correlation is a statistical test for a linear relationship between two variables. Pearson's Correlation can vary between -1 and 1. A correlation of 0 means there is no linear relationship between the variables. -1 and 1 indicate perfect negative and perfect positive linear relationships respectively. Setting values outside of threshold to 0 and including them in calculation of mean for each channel biases results towards the positive and will be detrimentally affected by background signals. Interpreting values below 0.5 is difficult. For this reason Volocity offers the thresholded Pearson's Correlation Coefficient as described above.

Voxel Ratio Ch.X / Ch. Y refers to the ratio of number of voxels within threshold and may be used to assist in interpreting the thresholded statistic overlap coefficient (R).

For further explanation of these statistics see the following references:

M.M. Manders, P. J. Verbeek & J. A. Aten

Measurement of co-localization of objects in dual colour confocal images
Journal of Microscopy 1993 Vol. 169, pp. 375-382

S. Bolte & F. P. Cordelieres

A guided tour into subcellular colocalization analysis in light microscopy
Journal of Microscopy 2006 Vol. 224, pp. 213-232

Generating Output

There are two methods for generating output using the principles of the Colocalization View:

- n Generate Colocalization, which can be set up to generate a field statistics measurement, a scatter plot, a colocalization channel, a merged channel, and PDM channels for all timepoints.
- n **Calculate Object Colocalization** task used in a measurement protocol, which measures the Pearson's correlation coefficient and colocalization coefficients M_x and M_y for each object and displays them in the table area of the Measurements View.

Generate Colocalization

Select **Generate Colocalization** from the Colocalization menu and choose the required output. This will be generated for all timepoints in the image sequence.



Field statistics are measurements recording the co-localisation statistics of the voxels included in your analysis. Each time point in your image sequence will have a row devoted to it in the field statistics measurement item.

- n The scatter plots are saved to a folder in the current library. Each scatter plot is stored as a 2D image and may be exported.
- n A Colocalization channel is made from any voxels that are selected with a ROI on the scatter plot. These voxels are marked in the Colocalization view preview with the colored overlay i.e. those

that are selected on the scatter plot. The channel is produced from a brightest point merge honoring the color and intensity of those voxels in the original channels. If no voxel are selected on the scatter plot the colocalization channel appears black.

- n A merged channel is made by generating a brightest point merge of the two source channels. Merged channels such as this are often used for simple red plus green gives yellow (in areas on colocalization) visual analysis of colocalization. We recommend that you only use this channel for simple visual illustration purposes.
- n PDM channels are generated by calculating the product of the difference from the mean for each voxel from the two channels analyzed. For two channels, X and Y the following calculation is performed at each voxel:

$PDM = (X_i - X_{mean}) \cdot (Y_i - Y_{mean})$ Where X_i is the intensity of the voxel for channel X and Y_i is the intensity of the voxel for channel Y.

PDM Channels

Volocity generates two PDM channels, a positive channel which is colored yellow, and a negative channel which is colored purple.

Voxels for which both X_i and Y_i are above the mean show positive correlation and are included the positive (yellow) PDM channel.

Voxels for which either channel is below the mean whilst the other channel is above the mean show negative correlation (exclusion) and are included in the negative (purple) PDM channel.

Voxels for which both channels are below the mean are not displayed in the PDM channels.

Although the negative PDM channel is derived from negative values, all the voxels in this channel are displayed as positive values.

Both PDM channels are floating point channels, the highest possible PDM value is calculated by performing the PDM calculation $((X_i - X_{mean}) \cdot (Y_i - Y_{mean}))$ with all possible combinations of the highest and lowest voxel values in the two channels, regardless of whether the voxels with these extreme values are actually co-localized or not. The greatest possible value generated from the extreme values is normalized to 1, all the voxels in the PDM channels are displayed according to this scale. The white point of both PDM channels is set to 1, the black points are set to 0.

The PDM channels are intended to give a clear visual display of areas and degree of positive correlation (in yellow) and areas and degree of negative correlation in (in purple).

If both channels show random distributions both PDM channels should look dark.

A template channel is generated if your analysis was restricted to a ROI in the preview. The overlay is intended to clearly illustrate which voxels were included in the analysis. Voxels with a value of 0 in the template channel were included in the analysis, voxels with a value of 255 in the template channel were excluded from the analysis.

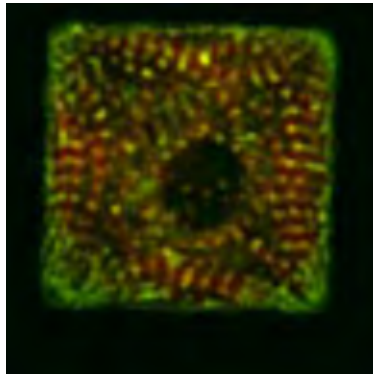

Red and Green merged image

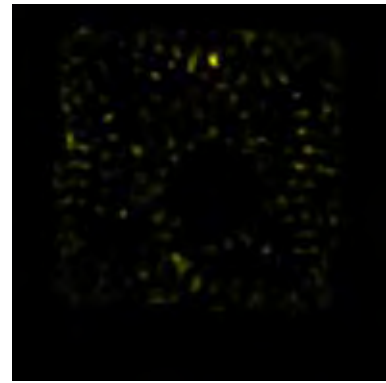

Positive PDM image

Calculate Object Colocalization

Use this task within a measurement protocol in the Measurement View. Find objects using tasks added to the protocol and then add Calculate Object Colocalization to generate Pearson's Correlation, M_x and M_y for each. As discussed above, it is essential to set thresholds for each channel and the Measure Object Colocalization task allows thresholds to be set. Alternatively, after configuring the Colocalization View the settings in the view may be read into the task.

The Measure Object Colocalization task calculates M_x and M_y for the voxels present within objects selected by the rest of the protocol. The earlier stages of the protocol find objects. M_x and M_y are calculated for those objects. The calculation on the voxels in each object is therefore:

sum of intensities of colocalized voxels within threshold range/ sum of intensities of voxels (colocalized and not colocalized) within threshold range.

Important Considerations

It is important to have adequate separation of the two fluorescence signals, with no overlap between emission of one and excitation of the other. This affects choice of filters as well as fluorochromes themselves.

Colocalization can only analyze the voxel values presented in the selected images. It is the user's responsibility to ensure the images are valid for the study they are carrying out.

Users may wish to deconvolve images before processing. Iterative Restoration is appropriate for this application since it preserves voxel intensity values, see page 509.

Colocalization assumes that there has been no voxel shift between the capture of the two channels and that they are perfectly aligned. Adequate controls are also essential to avoid the possibility of false colocalization, for example generated by non-specific labeling.

FRAP Analysis

Carrying Out FRAP Analysis

Only data that has been acquired with Volocity FRAP Acquisition may be analyzed with Volocity FRAP Analysis.

Prior to carrying out FRAP analysis you should consider applying the following corrections to your FRAP recovery data:

- n Background correction
- n Photobleaching correction

Background Correction

Volocity provides a flexible background correction tool that allows you to correct images based on either division of images with a bright reference image, subtraction of a dark reference image or subtraction of fixed offset values from images (for more details please see [Correcting Background](#)).

If you wish to apply background correction to your FRAP image sequences, acquire any correction images that you require and create your background correction item in your library. Select the images that you wish to correct and apply background correction from the Tools menu.

Photobleaching Correction

The Volocity photobleaching correction tool corrects for photobleaching by applying correction factors to images that restore their intensity to the intensity of the first image in an image sequence. Without photobleaching correction it is likely that you will get an underestimation of the mobile fraction from your FRAP analysis.

There are two methods of applying photobleaching correction. Apply whichever is appropriate for your experiment.

- n **Based on a region of interest.** To apply a correction based on a region of interest you must have your image sequence open in the Image View. Select an ROI and then select **Correct Photobleaching...** from the Tools menu. Make sure that you select the appropriate channel for correction.

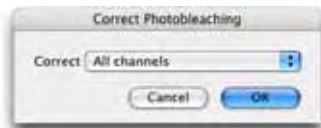

When photobleaching correction based on an ROI is applied Volocity multiplies the whole image by whatever correction factor is required for each time point to keep the ROI at 100% intensity throughout the image sequence. Because it requires an ROI to be selected it cannot be used to batch correct multiple channels.

- n **Based on the whole image.** Select **Correct Photobleaching...** from the Tools menu. Make sure that you select the appropriate channel for correction. Volocity multiplies the whole image by whatever correction factor is required for each time point to keep the whole image at 100% intensity throughout the image sequence. Photobleaching correction based on the whole image does support batch processing. To batch process several image sequences, select them in your Volocity library before selecting **Correct Photobleaching...** from the Tools menu.

Normalization

You may include as many data sets as you wish in a single FRAP analysis. So that multiple data sets can be pooled, Volocity normalizes FRAP data by setting the intensity of bleach areas in the last frame before bleaching to 1 and by setting the intensity in the first frame after bleaching to 0, all intensity measurements are then made according to this scale.

Select the image sequences that you wish to include in your analysis and select **FRAP Analysis...** from the Tools menu.

FRAP Analysis

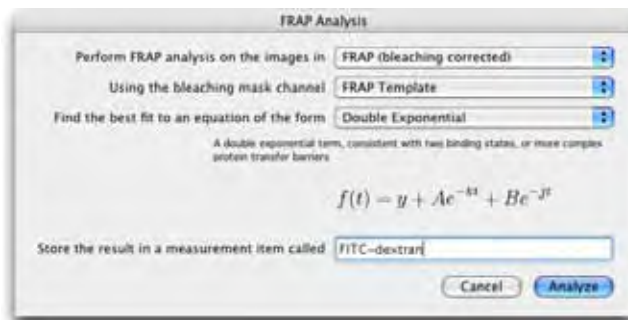

1. Select the channel on which FRAP analysis is to be performed.
4. Select the appropriate bleaching mask channel; this is the FRAP template channel created when we acquired the image sequence (the correct mask channel should be selected by default provided that the channel names have not been changed).
5. Select the appropriate equation.
 - n The Single Exponential equation is appropriate for a single binding state (see Sprague and McNally (2005) for further information on single binding states).
 - n The Single Constrained Exponential equation is appropriate for a single binding state where you wish to constrain the curve fit to have a value of 0 at time 0, i.e. pass through the origin.
 - n The Double Exponential equation is appropriate for two binding states or more complex transfer barriers. However, be aware that this equation will fit almost all recovery curves and does not necessarily indicate two binding states for your molecule of interest (see Sprague and McNally

(2005) for further information on two independent binding states and the caution required to use this equation).

- n The Soumpasis analytical solution (Soumpasis1983) provides a solution for pure diffusion.
- n Specify a name for the measurement item in which to store the result and click **Analyze**. When analysis is complete your measurement item will automatically open in the Chart view.

References

Axelrod D, Koppel DE, Schlessinger J, Elson E and Webb WW (1976)

Mobility measurement by analysis of fluorescence photobleaching recovery kinetics. *Biophys. J.* 16:1055-1069

Soumpasis D.M. (1983)

Theoretical analysis of fluorescence photobleaching recovery experiments. *Biophys. J.* 41:95-97

Sprague BL and McNally JG (2005)

FRAP analysis of binding: proper and fitting. *Trends in Cell Biology.* 15:84-91

FLIP Analysis

As with FRAP analysis, you may wish to background correct and photobleaching correct your image sequence before analysis.

. An image sequence making up a FLIP experiment consists of three elements:

- n a bleached area of interest
 - n a non- bleached area of interest. The experiment is to determine whether the molecules are moving between the two areas and at what rate.
 - n A control cell or region of interest from a compartment that is not connected to the bleached areas in any way.
1. Open your image sequence in the measurements view.
 6. Select ROIs for analysis. In this case ROI A may be connected to the bleach area (mobile molecules would be free to diffuse between the bleach area and ROI A), but ROI B can not possibly connected to the bleach area. A dramatically higher bleach rate for ROI A than ROI B would demonstrate that molecules are freely diffusing between ROI A and the bleach area.

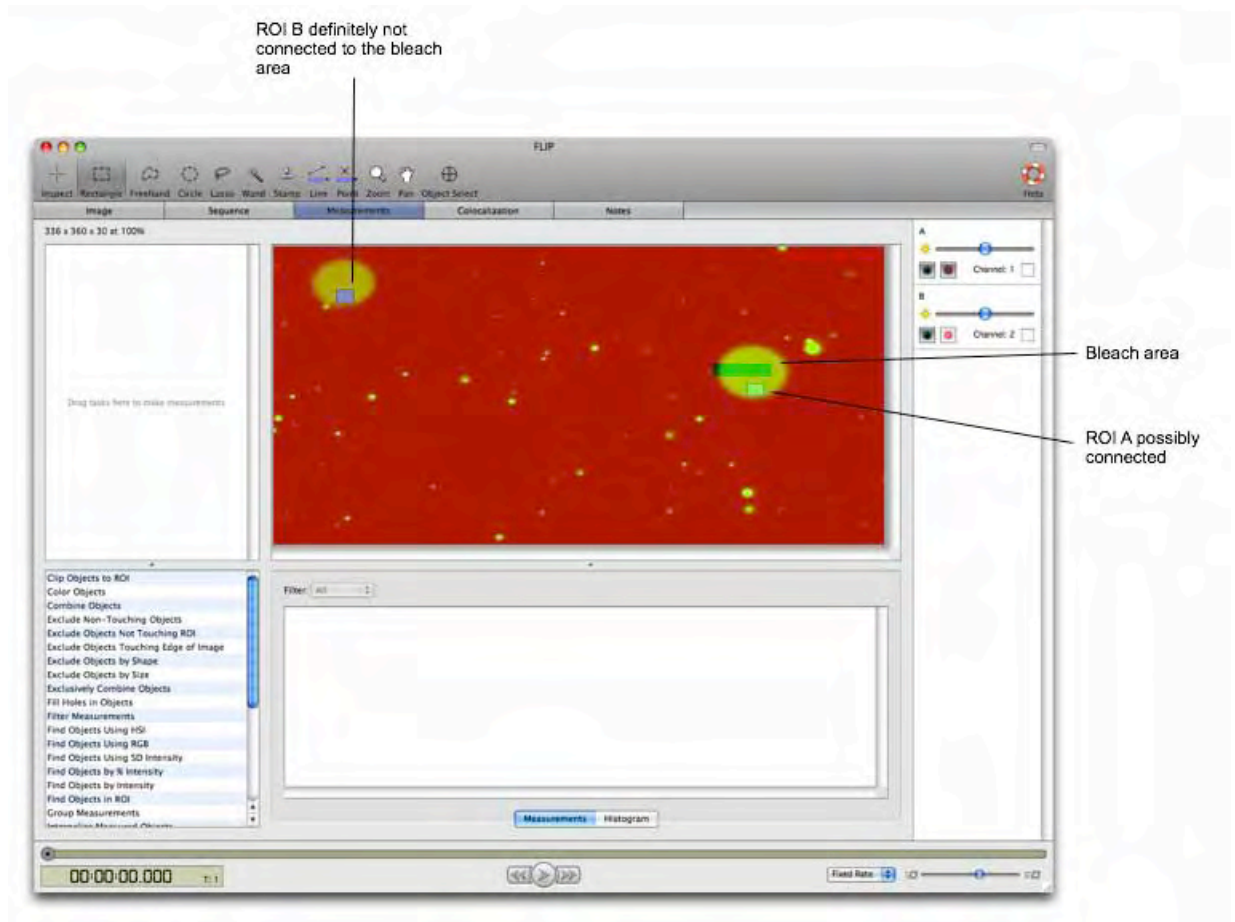

7. Select **Measure all timepoints** from the Measurements menu.
8. Select **Create measurements item** from the Measurements menu.
9. Name your measurements item and click **OK**.
10. Open the measurements item and select the Analysis tab. Select **Analyze** from the Analysis menu.
The Edit Analysis dialog opens.



Set the Analysis dialog as follows:

- n Analyze these data = **Mean**
- n Summarize by = **Value**
- n Row = **Timepoint**
- n Column = **Name**
- n Page = **None**

11. In the Normalize tab check the **Normalize to data**, and select timepoint 1 from the drop down menu. This results in intensity values being calculated as a percentage of their initial values. This makes changes in intensity clearer, and makes comparison of the intensity changes in the two areas possible.

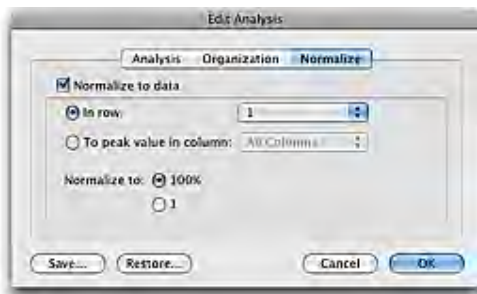

12. Click OK.

Timepoint	Value of ROI Object 1 (Channel 1)	Value of ROI Object 1 Normalized to control (N) (Channel 1)	Value of ROI Object 2 (Channel 1)	Value of ROI Object 2 Normalized to control (N) (Channel 1)
1	34.77178	100	32.242751	100
2	34.75	99.917162	32.15404	99.709427
3	34.494318	99.202648	31.967766	99.131769
4	34.179504	98.297864	31.927486	99.161151
5	34.371922	99.85005	31.992129	99.207318
6	34.288589	98.620192	32.099425	99.559713
7	34.404119	98.942645	32.222619	99.922127
8	34.462811	99.111495	32.00497	99.487692
9	34.267756	98.550478	32.127436	99.626905
10	31.956917	97.656527	31.715517	98.349547
11	33.878788	97.431647	31.371064	97.281402
12	34.040246	97.836183	31.851655	98.80749
13	34.049553	97.924099	31.58358	97.959018
14	31.570543	96.546165	31.646127	98.134524
15	39.352746	113.174378	35.330054	109.750456
16	39.47893	113.58727	35.686807	110.681682
17	39.183712	112.688254	35.5491	110.237456
18	38.903493	111.882132	34.983643	108.421938

13. Your Analysis now contains four columns. Two with raw intensity values over time and two with normalized intensity values over time. So that you plot only the normalized values hide the columns containing raw values. Select **Analysis Columns...** from the Analysis menu and uncheck the boxes corresponding to the raw values (leaving the boxes that correspond to normalized values checked) and click **OK**.



14. Select the Chart Tab.

15. Select the **Setup Chart** button

16. In the Edit chart dialog set the chart to "Line" and click **OK**.

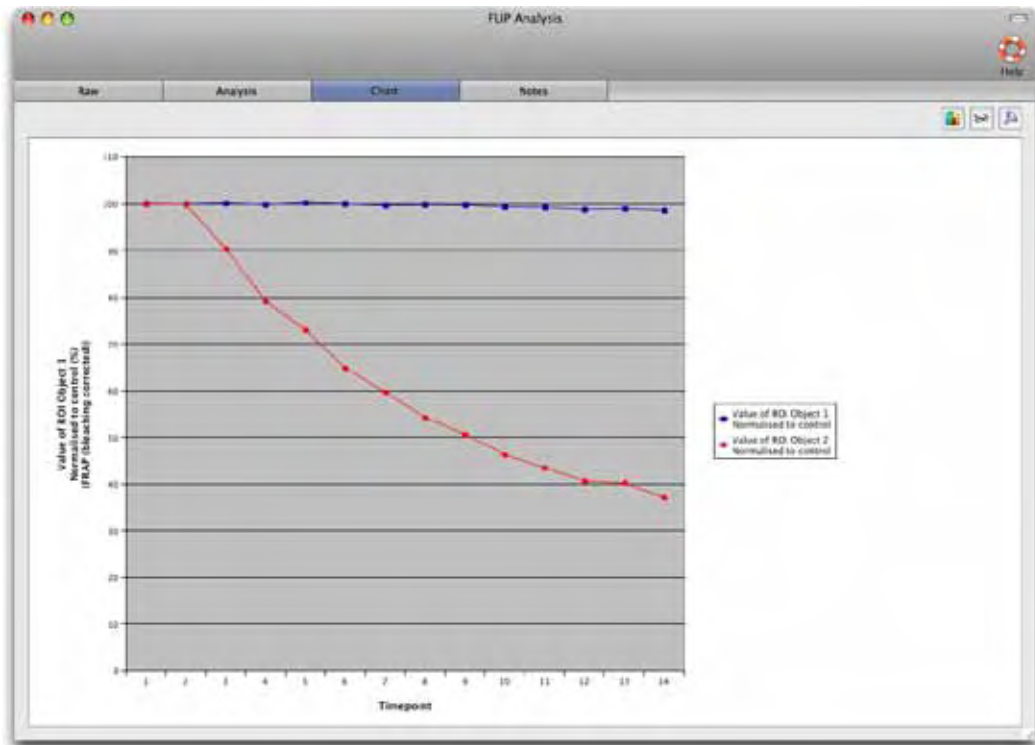

In our example we can see that ROI A (plotted in Red) loses fluorescence in comparison to ROI B (plotted in blue). This demonstrates that the fluorescence material in ROI A is able to move freely into and out of the bleaching area, unlike the material in ROI B which can never enter the bleaching area. In this case photobleaching was corrected based on a third ROI, which was unconnected to ROI A or B.

FRAP Measurement Item

The same analysis without photobleaching correction is shown below. Even without photobleaching correction fluorescence is clearly lost at a much higher rate in ROI A (red) than ROI B (blue).

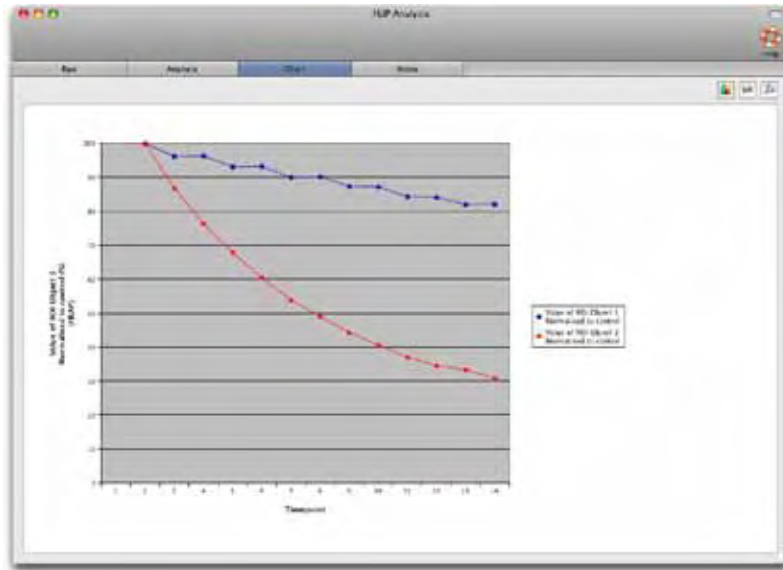

FRAP Measurement Item

The **FRAP Analysis...** command in the Tools menu generates a measurement item. Designed specifically for FRAP analysis the information in this measurement item will be laid out in a different way compared to one created by other measurement actions in Volocity and you will interact with it differently.

The Chart View provides the most accessible view of the results. The FRAP measurement item will open to the Chart View by default.

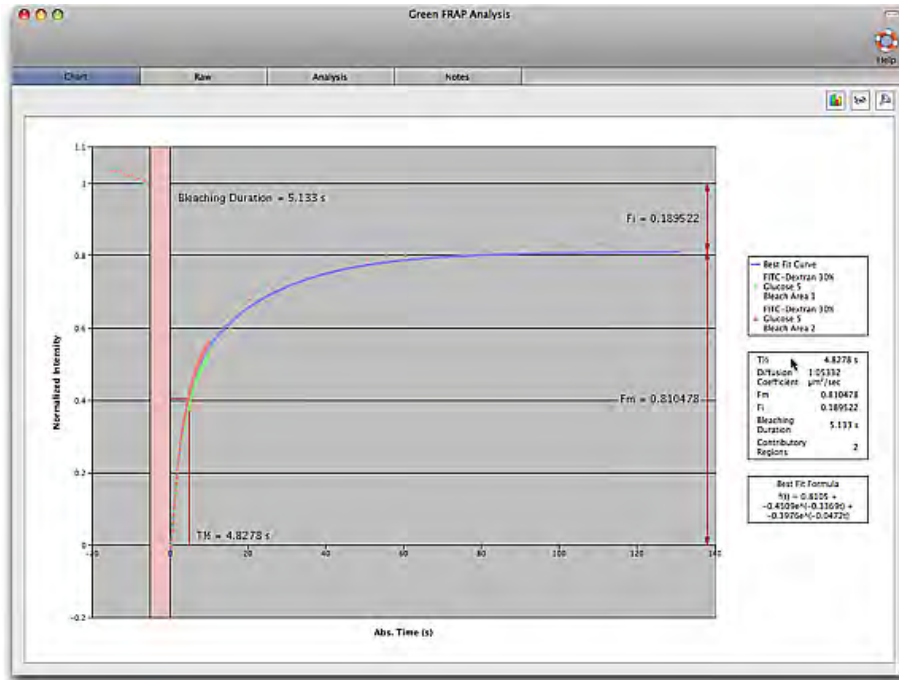

FRAP charts show the normalized recovery for each of your bleached areas (each recovery is plotted in its own color and style), as well as the best fit curve (shown with a line joining each point by default).

Parameters that are displayed either graphically or in the legend are shown in the table below.

Parameter	Method of Calculation	Chart or Legend	Reference
$T_{1/2}$	Time taken for the intensity of the bleached area to recover to half of the plateau intensity	Both	
Mobile Fraction (F_m)	Normalized intensity at plateau	Both	
Immobile Fraction (F_i)	Normalized pre-bleach intensity-normalized intensity at plateau	Both	
Diffusion Coefficient (D)		Legend	Axelrod et al 1976
Fitted Equation	Equations are fitted to the raw data using the least squares method	Legend	
T_D (Characteristic diffusion time, Soumpassis equation only)	Derived by fitting the Soumpassis equation to the raw data	Legend	Soumpassis 1983

For a more detailed view of the normalized intensity values from your recoveries as well as the curve fitted recovery values select the Raw tab. Note the Rel Time column; this represents the time relative to the first frame to be acquired after bleaching, which is set to 0.

The screenshot shows the FITC-Boxcar software interface with a data table. The table has the following columns: Time (s), Diffusion Coefficient (µm²/sec), Fit, Fit, Fit, Fit Formula, Subtracting Data (µm²/sec), Contribution Region, Ref. Time (s), Ref. FC Corr, Full (µM) (stacking corrected), and Full 2 (stacking corrected). The table contains 30 rows of data, with values ranging from approximately -0.18094 to 1.63433 in the Time column and 0.00000 to 1.00000 in the Diffusion Coefficient column.

Ratio Analysis

Velocity ratioing allows you to carry out offline analysis of ratioed pairs of images. It requires an image sequence containing at least two channels. The channels must be the same depth but may be 8-bit, 16-bit or floating point. The ratio is always calculated as Channel A / Channel B, therefore, it is important to specify the channels correctly in the Ratio dialog.

Applying Ratio Calculation

1. Open an image sequence containing 2 or more channels.
2. Choose **Ratio...** from the Tools menu. The ratio option is available when any of the tabs in the image sequence are active, but working from the Image View allows you to use an ROI drawn in that view to set background values for subtraction.

preview window
and multiple
timepoint play
controls

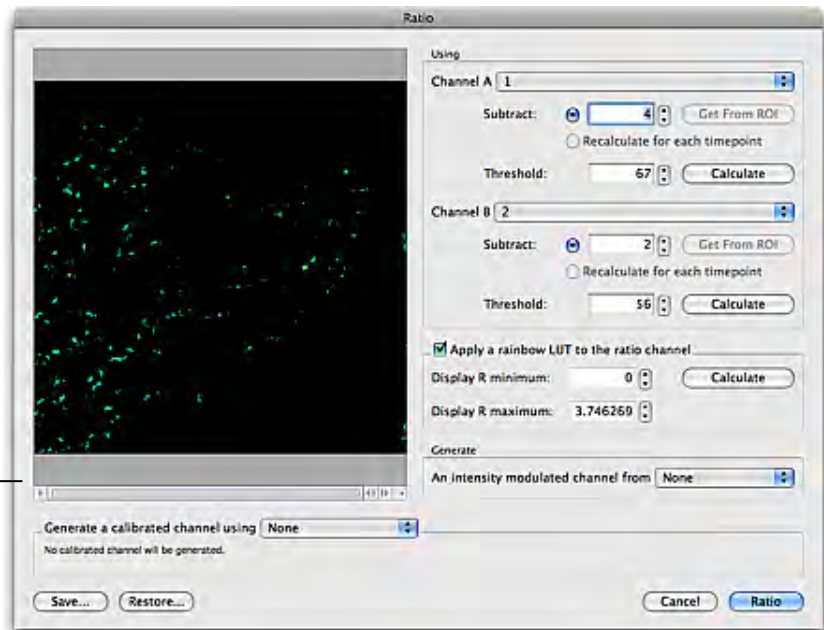

3. Select which channels in the image sequence should be used for **Channel A** and **Channel B**. A constant background value may be subtracted from every voxel in every image of each channel, if required. If source images are already background subtracted, go to step 4.

Note: Subtraction of a background constant is relevant only if the source images are evenly illuminated.

Enter a value in the **Subtract** field or draw an ROI on the Image View before opening the Ratio dialog and click **Get from ROI** next to the Subtract field. Volocity will use the mean intensity from that ROI for each channel as the value to subtract. This value will be subtracted from the intensity value of every voxel before processing the ratio calculation. If an ROI is drawn on the Image the option to **Recalculate for each timepoint** will be available and selecting it means the mean value in the ROI will be recalculated and used as the value for subtraction in each timepoint.

4. Set threshold values for each channel by typing a value in the **Threshold** field. Thresholds allow removal of signals that would interfere with interpretation of results.

For example, there will be areas in the images where low intensities in each of the A and B channels produce similar ratio values to higher intensities in other areas. Thresholds will mean a result of 0 (zero) is set when one of the source voxels has an intensity at or below the threshold.

Use the Voxel Spy to pick out an exact threshold value or ask Volocity to **Calculate** the value for you. The calculate option determines the modal intensity value for the channel and uses it as the threshold.

5. You may wish to apply rainbow colors to the ratioed channel. Check the **Apply a rainbow LUT to the ratio channel**. To optimize the use of the rainbow across the range of ratio values present within the results enter **Display R minimum** and **Display R maximum** values. This allows the finite range of colors available in the lookup table to be used to illustrate most effectively any changes in the ratio values. Click **Calculate** and the maximum and minimum ratio values for the current timepoint will be used. To easily compare ratio images with rainbow colors applied, they should all have the same **Display R minimum** and **Display R maximum** set. In the rainbow LUT the minimum value is shown as blue, the maximum as white. By setting **Display R minimum** and **Display R maximum** you are setting the black and white point of the images. This is what is done automatically by the Auto Contrast command in the Tools menu. Auto Contrast should, therefore, be used with caution if ratio images are to be used comparatively.

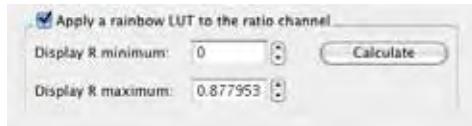

6. If required, generate an intensity modulated channel that will appear as a new channel in the image sequence. Select the modulator image from the **Generate** drop-down list. This generates a millions of colors display channel and may show morphology more clearly at the same time as indicating ratio values.

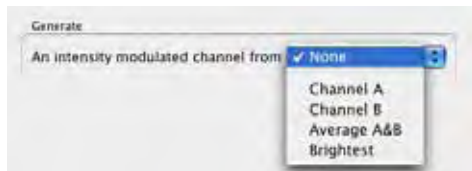

7. If a calibrated channel is required, select one of the two methods in the **Generate a calibrated channel using** drop-down list and enter the appropriate values in the table.

- n **Grynkiewicz:** Edit the four constants, as appropriate. These values will be applied to the Grynkiewicz equation (see page 493). The relevant constants for the current experiment must be determined according to Grynkiewicz et al (1985).

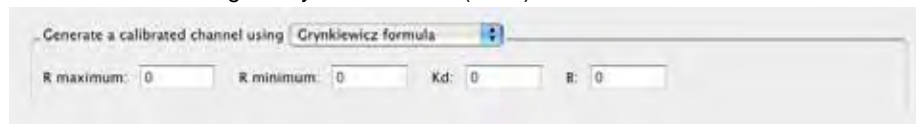

- n **Multi-point:** Use the values previously obtained from a calibration experiment for known correction of ion. Use the **+** button to create up to 11 (eleven) points in the table as required and enter the **Ratio value** and corresponding **Calibrated value**. These points are fitted to a third order polynomial or S-shaped curve. The preview graph provides a visual check that the calibrated values entered are sensible.

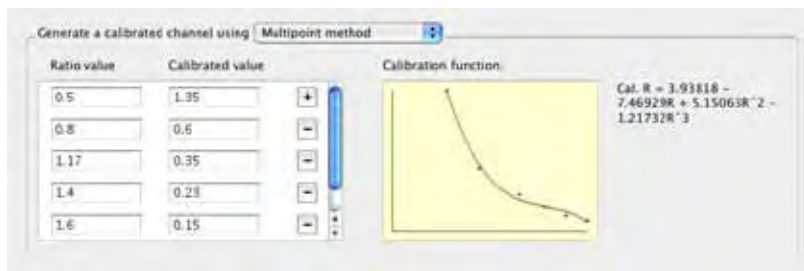

The preview shows a brightest point merge of the resultant ratioed image for the current timepoint. If the sequence contains multiple timepoints, use the play controls to view the effect of the parameters through the time series.

- Click **Ratio** to apply the ratio calculation and create a ratio channel in the image sequence. If specified, Volocity also creates a calibrated ratio and an intensity modulated channel. Channels may be hidden using the controls on the channel controls panel. If these are not visible go to the **Image** menu, **Show Channels**.

Note: If appropriate, use the **Save..** and **Restore...** buttons to save the settings for use in other experiments.

Measuring Ratio Channels

Target the appropriate channel when carrying out measurements, so that you obtain the required measurement units: ratio units or calibrated units. If drawing regions of interest to follow changes over time it may be beneficial to use the intensity measurements that ignore 0.

Using Color Reference with Ratio Images

To display ratio or calibrated images it may be beneficial to show the color reference on the Image View. This will show the values represented by the colors. Select **Show Color Reference** from the Image menu.

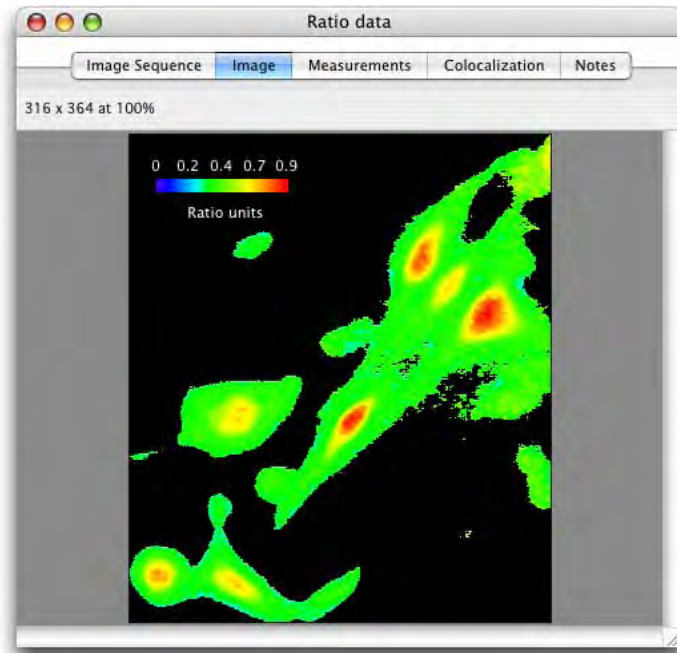

Grynkiewicz equation

$$[Ca^{2+}]_i = \frac{K_D * B * (R - R_{min})}{R_{max} - R}$$

Ca^{2+} = intracellular Ca²⁺ concentration

K_D = dissociation constant of fura-2

B = fluorescence signal at 380 nm at $0 \mu M \cdot l^{-1} Ca^{2+}$ / fluorescence signal at 380 nm at $39.8 \mu M \cdot l^{-1} Ca^{2+}$.

Grynkiewicz, G. Poenie, M. and Tsien, R. Y.

A new generation of Ca^{2+} indicators with greatly improved fluorescence properties.

Journal of Biological Chemistry 1985 Vol. 260, pp. 3440-3450

FRET Analysis

FRET analysis allows accurate FRET measurements and generation of net FRET (or "corrected" FRET) and normalized FRET images for publication.

The analysis currently offered by Volocity is the 3-image FRET technique, as described by Gordon et al. (1998) and Xia and Liu (2001).

References

The following references should be used to find further information on the technique and guidance on interpretation.

Gerald W. Gordon, Gail Berry, Xiao Huan Liang, Beth Levine, and Brian Herman

Quantitative Fluorescence Resonance Energy Transfer Measurements Using Fluorescence Microscopy. *Biophysical Journal* 1998 Vol. 74, pp. 2702-2713

Zongping Xia and Yeucheng Liu.

Reliable and Global Measurement of Fluorescence Energy Transfer Using Fluorescence Microscopes. *Biophysical Journal* 2001 Vol. 81, pp. 2395-2402

Youvan DC, Coleman WJ, Silva CM, Peterson J, Bylina EJ and Yang MM.

Fluorescence imaging micro-spectrophotometer. *Technology et alia* 1997 Vol. 1, pp. 1-16

FRET

FRET (Fluorescence Resonance Energy Transfer) is the non-radiative transfer of energy from an excited fluorophore (donor) to another fluorophore (acceptor). FRET only occurs when the molecules concerned are in very close proximity (1-10nm). This makes it a valuable technique for studies where distances and interactions between molecules are of interest.

Data Acquisition

Three images are required for each data point: a Donor image, an Acceptor image, and a FRET image. For example, one typical donor/acceptor pair is CFP and YFP.

n Donor image = Excite with CFP filter, CFP dichroic, emit with CFP filter

n Acceptor image = Excite with YFP filter, YFP dichroic, emit with YFP filter

n FRET image = Excite with CFP filter, CFP dichroic, emit with YFP filter

Volocity combines the three input images on a voxel-by-voxel basis according to the chosen FRET method. The output is a floating-point value at each voxel.

n All images should be in proper register before FRET analysis.

n Images must be grayscale 8, 16 or floating bit depth.

n All images must be the same depth.

Calculating Bleed-through Constants

Volocity requires two values that represent the bleed-through or cross-talk of each dye (Donor and Acceptor) into the FRET filter set. These values are calculated at the start of the experiment and should be recalculated if any change is made to the system that could affect transmission characteristics or sensitivity to wavelengths of light.

Note: The FRET bleed-through dialog does not offer subtraction of any background values. If you wish to subtract background from the images used to calculate bleed-through, this should be done

before using the images in FRET analysis. Alternatively, calculate your own bleed-through using values obtained by measuring appropriate ROIs in the images, as follows:

(intensity within cell(s) recipient-background intensity recipient) / (intensity within cell(s) source-background intensity source)

1. First set up the constant for the Donor channel. An image sequence containing donor and FRET channels from a sample containing only the donor fluorochrome is required.
2. Define an ROI or multiple ROIs on the Image View.
3. Select **FRET Bleed-through...** from the Tools menu.

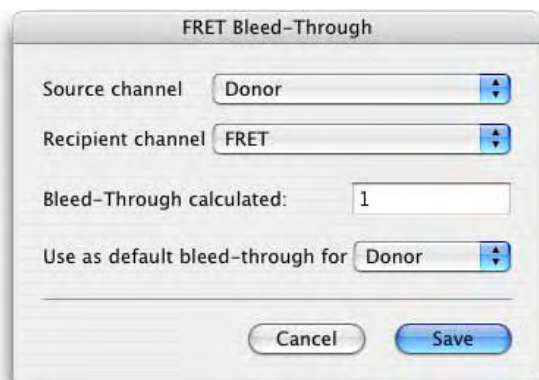

4. Nominate a **Source channel** (where the bleed-through is coming from, in this case the donor channel) and a **Recipient** channel (where the bleed-through is detected, in this case the FRET channel). In a sample containing only donor fluorochrome any signal detected in the FRET channel must be bleed-through.
5. Select the channel to which the bleed-through constant should be applied in the **Use as default bleed-through constant for** drop-down list, in this case **Donor**.
6. Click on **Save**. The constant will be applied when you carry out the FRET calculation, as described in the next section. The bleed-through value is a normalised percentage between 0.0 and 1.0.
 - n The value is calculated as the mean intensity of the recipient divided by the mean intensity of the source.
 - n If you have defined multiple ROIs, Volocity calculates a mean of the mean values.

- Now create the constant for the Acceptor channel. An image sequence containing acceptor and FRET channels from a sample containing only the acceptor fluorochrome is required. Repeat steps 2 to 6.

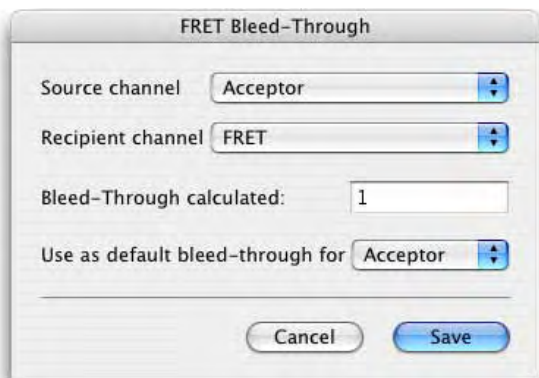

Using the FRET dialog

- Open an image sequence containing 3 or more channels, which represent a Donor channel, an Acceptor channel and a FRET channel.
- Choose **FRET...** from the Tools menu.

preview window
and multiple
timepoint play
controls

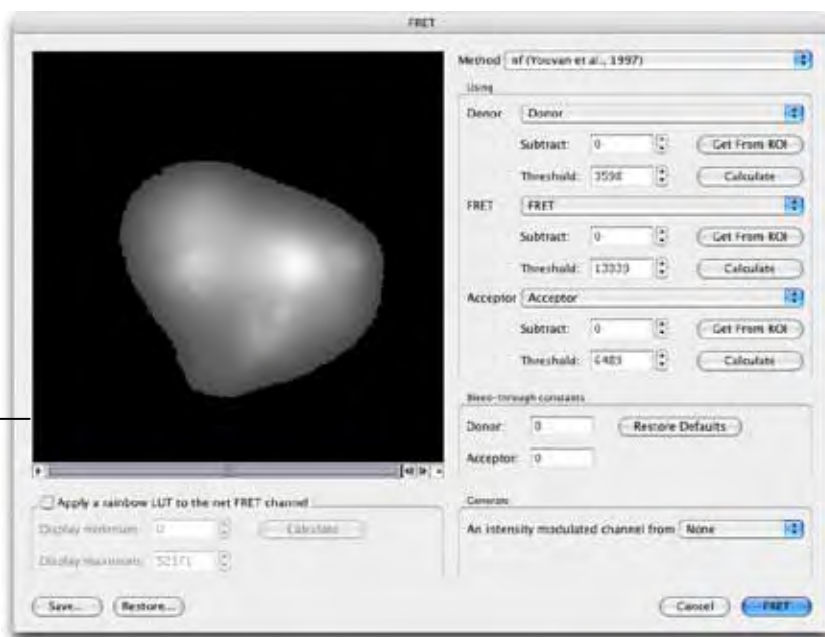

3. Select the **Method** of FRET calculation to be used from the drop-down list.

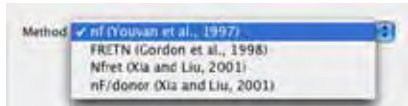

4. Select which channels should be used for **Donor**, **FRET** and **Acceptor**. A constant background value may be subtracted from every voxel in every image of each channel, if required. If source images are already background subtracted, go to step 5.

Note: Subtraction of a background constant is relevant only if the source images are evenly illuminated.

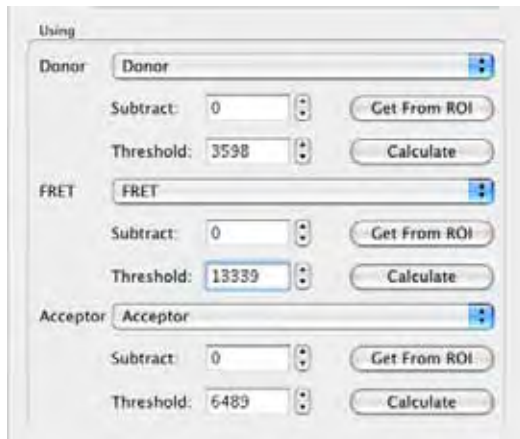

Enter a value in the **Subtract** field or draw an ROI on the Image View before opening the FRET dialog and click **Get from ROI** next to the Subtract field. Volocity will use the mean intensity from that ROI for each channel as the value to subtract. This value will be subtracted from the intensity value of every voxel before processing the FRET calculation.

5. Set threshold values for each channel by typing a value in the **Threshold** field. Thresholds allow removal of signals that would interfere with interpretation of results.

For every voxel position for which one of the source voxels has an intensity value at or below threshold, the value of that voxel position in the result image is set to 0 (zero).

Use the Voxel Spy to pick out an exact threshold value or ask Volocity to **Calculate** the value for you. The calculate option determines the modal intensity value for the channel and uses it as the threshold.

6. Enter bleed-through constants to be used. Click **Restore Defaults** to apply the Bleed-through constants stored from the last bleed-through calculation.

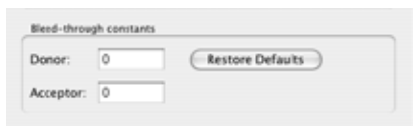

7. Preview the corrected FRET image. The preview shows a brightest point merge of the resultant FRET image. If the sequence contains multiple timepoints, use the play controls to view the effect of the parameters through the time series.
8. You may wish to apply rainbow colors to the output channel. Check the **Apply a rainbow LUT to the net FRET channel**. To optimize the use of the rainbow across the range of values present within the results enter **Display minimum** and **Display maximum** values.

This allows the finite range of colors available in the lookup table to be used to illustrate most effectively any changes in the FRET values. Click **Calculate** and the maximum and minimum FRET values for the current timepoint will be used. To easily compare FRET images with rainbow colors applied, they should all have the same **Display minimum** and **Display maximum** set. In the rainbow LUT the minimum value is shown as blue, the maximum as white. By setting **Display minimum** and **Display maximum** you are setting the black and white point of the images. This is what is done automatically by the Auto Contrast command in the Tools menu. Auto Contrast should, therefore, be used with caution if FRET images are to be used comparatively.



9. If required, generate an intensity modulated channel that will appear as a new channel in the image sequence. Select the modulator range from the **Generate** drop-down list. This generates a millions of colors display channel and may show morphology more clearly at the same time as indicating FRET values.

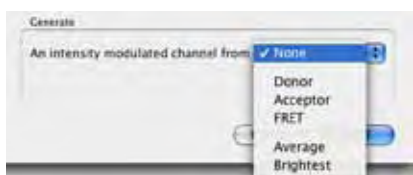

10. Click **FRET** to apply FRET calculation and create a corrected FRET channel in the image sequence. If specified, Volocity also creates an intensity modulated channel. New channels created will be reflected by extra controls in the Channel Controls panel and may be hidden using these controls. The Voxel Spy tool will show the relevant netFRET or corrected FRET values where appropriate. .

Measuring Corrected FRET Channels

FRET channels in image sequences may be measured in the same way as any other channel. When measurements are made on a FRET channel values for min, max, mean will be in the appropriate FRET units. If drawing regions of interest to follow changes over time, it may be beneficial to use the

intensity measurements that ignore 0. This will ensure that if background areas are included when the ROIs are drawn, they will not influence the results.

See other sections of this chapter for details on how to use measurement tools and the classifier.

Using Color Reference with FRET images

To display corrected FRET images it may be beneficial to show the color reference on the Image View. This will show the values represented by the colors. Select **Show Color Reference** from the Image menu.

Intensity Modulated Images

The IM image uses pseudocolor and intensity to display a FRET output image. Color is used to represent FRET values, intensity represents the intensity of one of the input images. This technique helps reflect spatial information since the intensity of the original images is reflected in the resultant image.

To produce the IM image the intensity of each voxel of the FRET output image is scaled based on the range of intensities in the input images. The source image used for this is called the modulator image. The modulator image can be one of the source images, the brightest of the source images or the average of the source images.

The range of colors in the IM image is determined by the look up table applied to the FRET output image.

The range of intensities in the IM image is determined by the range of intensities in the modulator image.

The IM image is a millions of colors image. It is, therefore, a visualization tool not suitable for quantitation.

Volocity Restoration

Overview

Volocity Restoration is a separate product in the Volocity family that must be purchased separately. See page 38 for more information about activating additional products.

Volocity Restoration offers two powerful techniques that allow you to apply deconvolution to an image sequence or volume. These techniques are:

- n **Iterative Restoration**, which is a restorative technique that reassigns out-of-focus haze (it does not subtract it from the data). It is designed to minimize out-of-focus haze and noise throughout the volume. Iterative restoration not only gives improvement in resolution in X and Y, but most significantly, also in Z. The results are applicable for 3D visualization and all 3D measurements provided by Volocity Quantitation, including intensity measurement. The processing required to achieve this is both time and memory intensive.
- n **Fast Restoration**, which is a rapid, single pass process that acts on the volume as a whole. Out-of-focus It gives improvement in resolution in X and Y and, to a lesser extent, in Z.

Data Acquisition

Restoration is performed on z series of images that are managed within Volocity as either individual volumes or within image sequences. The acquisition process requires careful consideration in order to obtain optimum results from Volocity Restoration. In particular, the following acquisition issues may affect the quality of the deconvolved image data:

- n Undersampling, particularly in the z axis
- n Saturation of the signal within images
- n Uneven illumination due to an unstable light source
- n Premature cropping of the signal by capturing too little in X, Y and Z around the sample

Please refer to Sampling Widefield Data for Deconvolution on page 517 for a more detailed discussion about the requirements for sampling wide field microscopy data for deconvolution.

Point Spread Function (PSF)

In order to apply either fast or iterative restoration, you must first create a PSF item. This is used to model the behavior of light in the optical system and must be appropriate for the data that is to be deconvolved. You can create a PSF in two ways:

- n **Calculated PSF**, which is based on values entered into the **Calculate PSF...** dialog box. These values should be the same as the parameters under which the data for deconvolution was acquired. The application uses the values to calculate an appropriate PSF and create a new PSF item.
- n **Measured PSF**, which is based on a volume (typically made from a z series of images of a sub-resolution, fluorescent bead) acquired under the same conditions as the experimental data. The application measures the PSF in the bead volume and creates a new PSF item.

Note: See *What Causes Axial Elongation of Structures in Optical Microscopy?* on page 521 for a discussion of the reasons why beads might appear as ellipses instead of spheres in optical microscopy.

Creating PSF volumes can be time consuming. Improvise, therefore, recommends that you create a library of PSF volumes for different objectives and camera settings, export them in the library clipping format to a storage location and drag them into the active library as they are needed. If you double click on a PSF icon in the library, it will open an Image View with an extra column on the right of the window containing the PSF data.

Note: Please see the Glossary starting on page 513 for a definition of PSF parameters.

Data Calibration

The method of calculating and using point spread functions within Volocity 2.5 and later requires that all data used within Volocity Restoration be correctly calibrated before use. This applies to raw data for deconvolution as well as volumes from which a PSF is to be measured. Check the data calibration before commencing by selecting **Properties** from the Edit menu. Correct the X, Y or Z micron/pixel values, if necessary. See 63 for more information on item properties.

Calculate PSF

This dialog is used to calculate all types of PSF available in Volocity, including Widefield, Confocal, Two Photon and Spinning Disk Confocal PSFs.

1. From the Actions menu, select **Create New** and **Calculated PSF...**
2. In the dialog select the required type of PSF from the pop-up.

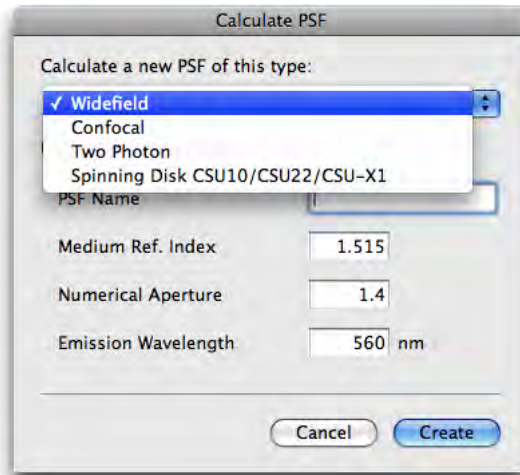

3. Enter a name for the PSF This name will identify the PSF item in the library and in the dialogs used to apply Restoration so use a name which will identify what the PSF is to be used for.
4. Enter the values relevant for the data that is going to be deconvolved with this PSF.
5. Click on **Create** or **Calculate** to create the PSF item.

The PSF calculated from the dialog is supersampled. Calculated PSFs may be used with images acquired at any spatial resolution, the PSF is adjusted according to the calibration of the image data during the process of deconvolution.

Note that when deconvolving the volume, Volocity requires the calibration values to be correctly set, or the PSF used will not be accurate. If you attempt to deconvolve a volume for which the calibration values appear not to have been set, you will be reminded to set these values before proceeding.

Measure PSF

The spinning disk is used in such systems as the PerkinElmer *Ultra View*. This PSF is unique to a spinning disk with the spiral pinhole configuration, pinhole size, and pinhole spacing of the CSU10/CSU22/CSU X1 spinning disk and should not be used to calculate the PSF for any other type of spinning disk.

Calculate PSF

Calculate a new PSF of this type:

Spinning Disk CSU10/CSU22/CSU-X1

Using these parameters:

PSF Name

Medium Ref. Index

Numerical Aperture

Laser Excitation Wavelength nm

Emission Wavelength nm

Objective Magnification x

Measure PSF

This dialog is used to measure all types of PSF available in Volocity.

1. You will need a volume representative of a PSF, such as z sections taken of a sub resolution, fluorescent labeled bead. Such images must be acquired from the system generating the experimental image data. Volocity Acquisition may be used to acquire such a 3D stack.
2. Select the PSF bead volume in the library and, from the Actions menu, select **Create New** and **Measured PSF...**

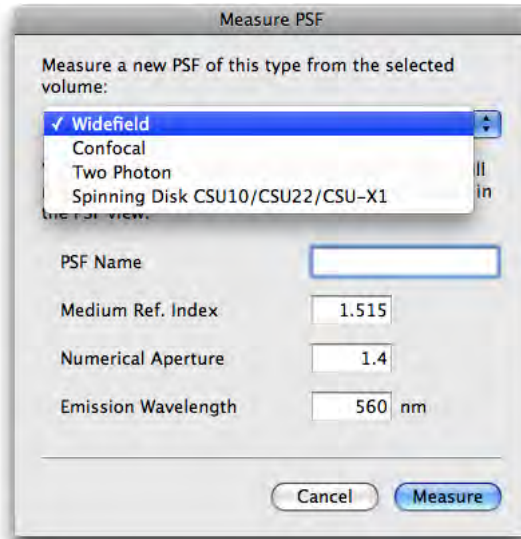

3. In the dialog select the required type of PSF from pop-up.
4. Enter a name for the PSF. This name will identify the PSF item in the library and in the dialogs used to apply Restoration so use a name which will identify what the PSF is to be used for. All other values are optional. You may like to record the other acquisition parameters for the PSF bead as a reminder, but they are not used to create the PSF item.

The following example shows the dialog for a widefield PSF.

5. Click on **Measure**.

Note that when deconvolving the volume, Volocity requires the calibration values to be correctly set, or the PSF used will not be accurate. If you attempt to deconvolve a volume for which the calibration values appear not to have been set, you will be reminded to set these values before proceeding.

Applying Fast Restoration

You can apply Fast Restoration to a single volume, to an image sequence, or to multiple image sequences selected in the library.

Make sure the library contains the required PSF volumes. You will need a PSF for each wavelength and lens type.

1. Select items to be restored in the library. All items must be correctly calibrated, by setting X, Y and Z properties, to ensure PSFs are used at the correct resolution.
2. Select **Fast Restoration...** from the Tools menu. The dialog will show a list of all the unique channel names identified in the selected data. The restoration dialogs support batch processing. Where multiple items have been selected channels in the different items can have the same names and each name will only appear once in the dialog so will be processed using the same PSF.

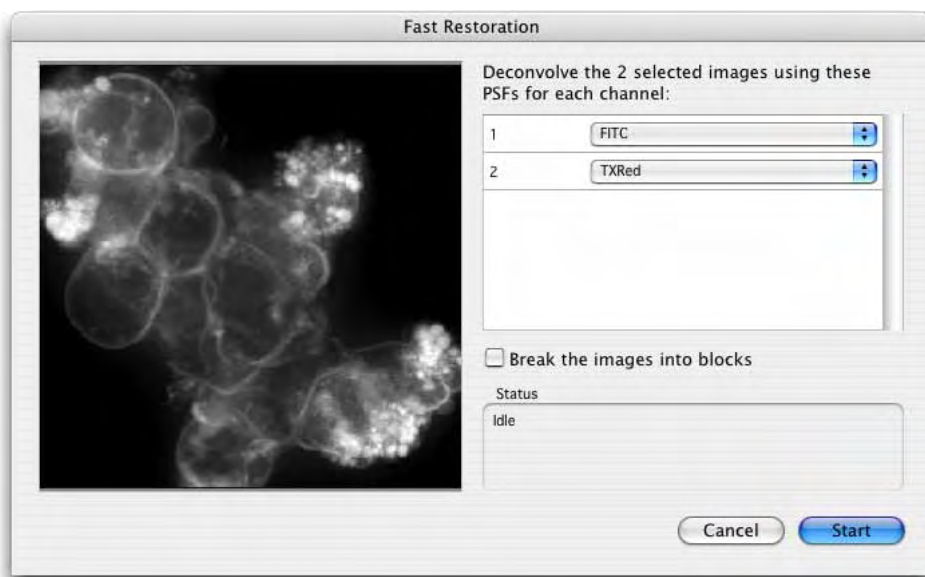

3. For large data sets, you may like to check the **Break the images into blocks** checkbox. Deconvolution is a very memory-intensive operation and the software needs to hold multiple copies of the volume in memory at the same time so the space occupied in memory during restoration is much greater than the physical space occupied by the data on disk. Restoration will proceed fastest if all data required for the processing can be held in physical memory. When the data set size exceeds the amount of physical memory Volocity can break the images down into blocks which will fit, using the following calculation.

Memory per processor = physical RAM/number of processors.

Block size will therefore vary, not only with the size of the data set but also with the hardware configuration.

Based on this calculation the volume is divided into overlapping blocks. This overlap is used in the processing of each block but not copied to the result to minimize the deterioration of quality caused by breaking the images down.

Restoration will proceed more quickly since data will not have to be paged in and out of virtual memory. On systems with multiple processors blocks may be processed simultaneously, further increasing speed. Breaking images into blocks may lead to a slight deterioration in quality; depending on the nature of the data it may be possible to detect the edges of the blocks the data was broken down into.

Note: If it is calculated that the data fits into memory as a single block, it will be restored as a single block, even if the checkbox is checked.

4. Click on **Start** to apply Fast Restoration.

The preview window shows each volume as restoration is applied. While the deconvolution is being carried out the **Start** button will change to **Pause**. You can pause the process at any time, for example if you want to interact with the preview. Click on the button (now labeled **Start**) a second time to restart the processing. If you click **Done** while the deconvolution is paused, the deconvolved data will not be saved.

The Status window shows progress details.

5. Once all the selected channels have been deconvolved, click **Done**. When deconvolution is completed, each channel will have a deconvolved equivalent with a name indicating that Fast Restoration was applied; the raw data is not replaced with deconvolved data.

For single volume(s) the name of the new volume includes the text 'Fast DCI' and the name of the PSF used.

Applying Fast Restoration

For image sequences the results are added as new channels, so information about the type of restoration applied is in the name of the new channels and the tooltip shown when the cursor is held over the channel. If the data was broken down into blocks the number of blocks is recorded.



Applying Iterative Restoration

You can apply Iterative Restoration to a single volume, to an image sequence, or to multiple image sequences selected in the library. Iterative Restoration is a multiple step process; each cycle or iteration increasing the quality of the resultant image and therefore confidence in the result. The termination condition of the this process can be set by iteration limit (number of iterations) or confidence limit (percentage).

Make sure the library contains the required PSF volumes. You will need a PSF for each wavelength and lens type.

1. Select items to be restored in the library.
2. Select **Iterative Restoration...** from the Tools menu.

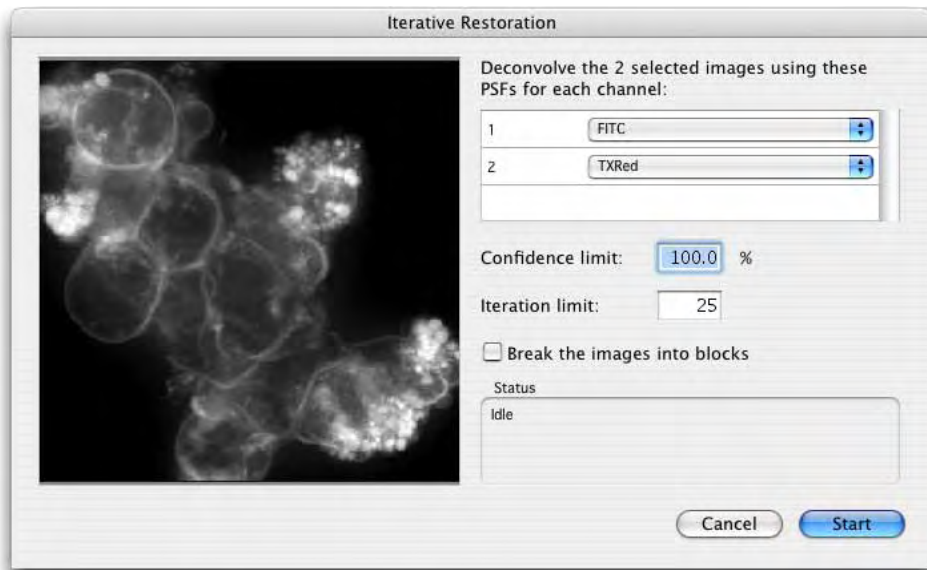

3. Select the appropriate PSF for each channel from the drop-down menu. Select the appropriate PSF for each channel from the pull-down menu. The restoration dialogs support batch processing. Where multiple items have been selected channels in the different items can have the same names and each name will only appear once in the dialog so will be processed using the same PSF.
4. Either set a confidence limit or an iteration limit. The deconvolution will terminate when one of limit conditions is met. Set 100% confidence to limit by iterations, set 100 iterations to limit by confidence. Confidence is calculated after each iteration and is the result of testing the results of deconvolution against the original data. 100% confidence indicates that restoration can offer no further improvement to the image. This may take many iterations to reach. Many datasets can be deconvolved extremely successfully with the confidence limit set to 98% or 99%. It may take a

different number of iterations to reach the same confidence limits for different channels. We recommend an iteration limit of 20 - 25 for widefield images, 10 for confocal images. You should not need to change this for different data sets.

5. For large data sets, you may like to check the **Break images into blocks** checkbox. Deconvolution is a very memory-intensive operation and Volocity needs to hold multiple copies of the volume in memory at the same time so the space occupied in memory during restoration is much greater than the physical space occupied by the original data.

Restoration will proceed fastest if all the data required for the processing can be held in physical memory. When the data set size exceeds the amount of physical memory Volocity can break the images down into blocks, which will fit, using the following calculation:

Memory per processor = physical RAM/number of processors

Block size will therefore vary not only with the size of the data set but also with hardware configuration.

Based on this calculation the volume is divided into overlapping blocks. This overlap is used in the processing of each block but not copied to the result to minimize the deterioration of quality that is caused by breaking the images down.

Restoration will proceed more quickly since data will not have to be paged in and out of virtual memory. On systems with multiple processors blocks may be processed simultaneously, further increasing speed. Breaking images into blocks may lead to a slight deterioration in quality, depending on the nature of the data it may be possible to detect the edges of the blocks the data was broken down into.

Note: If it is calculated that the data fits into memory as a single block, it will be restored as a single block, even if the checkbox is checked..

6. Click on **Start** to apply Iterative Restoration.

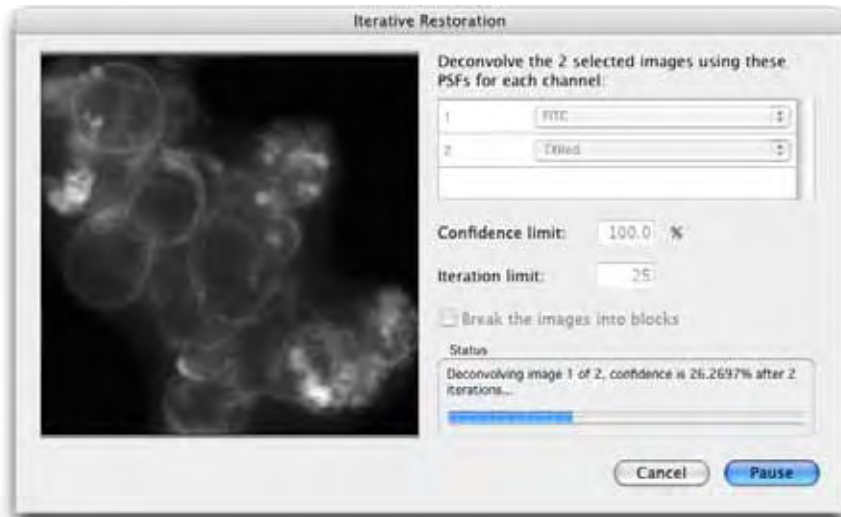

Feedback on progress is different depending on the use of **Break the images into blocks** option. When **Break the images into blocks** is not enabled the preview window shows a brightest point merge, updated with each iteration as restoration progresses. It is normal for the results of the first iterations to look worse than the original data since the first estimate of the true nature of the data in the image is based on the image itself.

The confidence factor will rise significantly with each iteration, however, the rate of increase will slow with successive iterations.

Note: While the deconvolution is being carried out the **Start** button will change to **Pause**. You can pause the process at any time, for example if you want to interact with the preview. Click on the button (now labeled **Start**) a second time to restart the processing. If you click **Done** while the deconvolution is paused, the deconvolved data will not be saved.

If **Break the images into blocks** is enabled feedback on progress is provided less frequently. The preview image, a brightest point merge of the volume is updated as each block is completed. The status box will show the number of volumes of the total completed and the number of blocks of the current volume completed. Progress will not be updated with each iteration.

7. Once all the selected channels have been deconvolved, click **Done**. When deconvolution is completed, each channel will have a deconvolved equivalent; the raw data is not replaced with deconvolved data.

After Iterative Restoration the result is meaningfully labeled, according to the processing it underwent.

For single volume(s) the name of the new volume includes the number of iterations, the confidence limit reached, the number of blocks (if applicable) and the name of the PSF used.

Illumination Correction

For image sequences the results are added as new channels, so the information about the type of restoration applied is in the name of the new channels and the tooltip shown when the cursor is held over the channel. If the data was broken down into blocks the number of blocks is also recorded.

Note: For both techniques, the first time a data set is deconvolved, it may take slightly longer than the second and subsequent times a data set of the same dimensions is processed. This is because one optimization present within Volocity Restoration is the storage of the method by which the Fast Fourier Transform (FFT) of a data set will be calculated. The next time a data set of those dimensions is encountered the method for calculating the FFT is already available, thus saving a processing step.

Illumination Correction

Minor anomalies in excitation light intensity over time, such as lamp flicker, can lead to poor deconvolution results. This will manifest itself as one or more inconsistently bright or dark layers in the deconvolved volume. The flicker may not be apparent during inspection of the raw data.

Better results can be obtained by applying illumination correction, then deconvolving the data again.

Select the required volume(s) and select **Correct Illumination** from the Tools menu.

Correct Illumination operates within each individual volume and bases any intensity correction solely on the trends shown within that volume. It does not normalize time resolved data to account for bleaching and cannot correct severe problems with lighting during the experiment. Ideally, lamp flicker should be avoided by using a stable light source.

Glossary

The definitions below explain the terminology used in this guide.

3D Opacity Renderer

Volocity calculates a projection—a screen image of how the volume appears from a specific viewpoint—using direct rendering from the 3D stack.

Black Level

The Black Level is a channel control when rendering data in 3D. It adjusts the intensity threshold below which renderers will treat data as transparent.

Detector Pinhole Size

This is a parameter in the calculation of a confocal PSF. It is the diameter of the pinhole used while acquiring the optical sections. Note: this is measured in airy units not micrometers. Not all systems display pinhole size in airy units and a conversion must be made.

Displacement

This is the straight line distance between the first centroid in a track and the last centroid.

Displacement rate

This is the displacement/(time of the last timepoint in the track – time of the first timepoint in the track). Displacement rate may also be defined as the average displacement per second.

Duplicate

The duplicate command allows you to duplicate items in the library, so that you can include items in a number of different folders.

Emission Wavelength

This is a parameter in the calculation of a PSF. It is the emission maximum of the fluorochrome imaged in the data set.

Excitation Wavelength

This is a parameter in the calculation of a confocal PSF. It is the excitation laser wavelength.

Fast Restoration

This is a rapid, single-pass process that acts on the volume as a whole. It gives resolution improvement in X and Y.

Folder

The library may be organised into a number of different folders that best suit your archiving/sorting requirements. Each folder may hold sub-folders or individual items. In this way you can organize your images into a number of different categories, each with a number of different levels.

Gallery

If you have sub-folders in the library of files whose format supports multiple images, for example Openlab LIFF files. The gallery view displays all the images in a single view.

Image

This relates to the bottom-level view of the library - the individual image, which may be 2D or 3D.

Image Sequencer

The Image Sequencer allows interaction with multiple channel, time resolved data by providing an easy-to-use interface for this data.

Iterative Restoration

This is a restorative technique that reassigns out-of-focus haze (it does not subtract it from the data). It is designed to minimize out-of-focus haze and noise throughout the volume. Iterative restoration not only gives improvement in resolution in X and Y, but most significantly also in Z. The results are applicable for 3D visualization and all 3D measurements provided by Velocity Classification, including intensity.

Keywords

A keyword is an item property that you enter on the Properties dialog to provide additional data about that item that can be used in the Find command.

Library

This is the structure within which the digital images are collected and organised. A library must be open in order to acquire or view images.

Meandering index

This is the displacement rate / velocity, which provides a measure of a track's deviation from a straight line. The meandering index is always a value less than or equal to 1. A meandering index of 1 indicates that the track is a perfect straight line; the smaller the value of the meandering index, the greater the meandering of the track.

Medium refractive index

This is a parameter in the calculation of a PSF. It is the refractive index of the medium between the objective lens and the cover slip. Typical values are 1.0 for air, 1.33 for water and 1.515 for oil.

Numerical aperture

This is a parameter in the calculation of a PSF. It is the numerical aperture of the objective lens. It can normally be found engraved on the objective lens.

Properties

These describe an item in the library. There are fixed properties, such as image size, source location and date details, which cannot be changed. Other properties, however, allow the user to add or edit information, such as adding keywords or changing the name.

PSF (Point Spread Function)

Images seen through a microscope contain information from the focal plane of interest plus out-of-focus information from other focal planes on the image. Volocity Restoration uses a technique called deconvolution to remove the out-of-focus information. This is a mathematical technique that calculates the out-of-focus information from other images using the "point spread function", or PSF, and subtracts this from the image plane of interest. It processes the Z stack of images as a complete data set, converting pixels to voxels (volume elements) to produce high-resolution, deconvolved images.

Skeletal length

This is the maximum length in the selected object and is shown in the Measurements. The selection is eroded evenly from its border inwards until it consists of a one-voxel thick, skeletal representation along its entire length. This "skeleton" is then measured.

Smooth zoom

The Smooth Zoom command on the View menu applies interpolation to the view to give better quality when viewing zoomed images and automatically sets the best quality for printing.

Thumbnail

The thumbnail is a representation of an item for quick display. The application automatically creates a thumbnail for each image or each layer in a multi-layer image.

Time span

This is the number of timepoints spanned by a track.

Volume

A volume is the name for a 3DI object within Volocity. It can exist as a single item within the library, created from a series of 2D images related in the Z-dimension or within an image sequence, which is a powerful tool for creating a collection of volumes arranged by channel and timepoint.

Voxel

This is the 3D equivalent of a pixel, the smallest discrete spatial component of a digital volume. Volumes within Volocity consist of voxels, each with an associated color and /or intensity value.

Appendices

Sampling Widefield Data for Deconvolution

Overview

This technical note contains a discussion of some of the requirements of data sampling to achieve optimal deconvolution results when using Improvion deconvolution software. Deconvolution will generate the best results when presented with the highest quality data.

Depth of Sample to Scan

Point spread of light sources from within a sample can extend above and beyond the limits of the physical top and bottom of that sample. Deconvolution uses out of focus information to calculate true sample data therefore it is important to capture the spread of light that extends beyond the sample boundary. This means capturing a large enough image size in X and Y and taking sample slices above below the object. As a rule of thumb, capture from darkness below the object to darkness above or half the thickness of the object of interest above and below, so that the total scanned distance is twice the thickness of sample object.

Measured PSFs

The acquisition of data for a measured PSF must be subjected to the same strict controls as the experimental data. Effort must be taken to minimise artefacts or aberrations. If these cannot be avoided then the data for the measured PSF should be collected with the same artefacts and aberrations as the experimental data. The bead used for measuring PSFs must be a speck bead of a size below the resolution of the microscope in order for the results to be valid. PSFs must be measured from a point source of light.

Optics and Illumination

The illumination pathway must be clean, free from dust and correctly aligned. Refer to the documentation supplied with the microscope to confirm how to align the epi-fluorescence light path.

Use high numerical aperture lenses. Try to match refractive indices through sample, cover slip and immersion medium.

If the illumination source output varies during the collection of a data stack this will result in there being differences in intensity between z planes which may be more apparent after deconvolution. Volocity Restoration offers a Correct Illumination function which can alter the data to remove these variations. It is always preferable to avoid introducing artefacts into images rather than correct for them later. Use an illumination source with a stable power supply. Lamp flicker is worse towards the end of the life of an arc lamp, replace bulbs if they show signs of flickering and always at the end of their recommended life.

Practical Considerations

The above information is for an ideal situation. In reality it may be necessary to compromise on some of the recommendations to stay within the performance limits of the hardware and to ensure survival of the specimen for the desired duration of the experiment.

Although operating the camera at its highest resolution will satisfy the Nyquist theorem for sampling frequency, it may be necessary to use binning to minimise sample exposure to UV light. In many cases the XY sampling will still be approximately half the size of the smallest resolvable object.

Imaging many stacks over time or imaging a sample which shows photo bleaching may require compromise on the number and spacing of z slices. It may be worth considering a volume deconvolution technique rather than an iterative restoration if the number of slices has to be reduced.

Sampling Frequency

A biological structure labeled with a fluorescent probe consists of continuous distribution of fluorescence. Imaging a biological sample means taking samples of this continuous fluorescence at discrete points in XYZ space (i.e. images). The frequency at which images are taken therefore affects the quality of the final result.

Nyquist Theorem

The Nyquist theorem states that in order to fully describe objects they must be sampled at twice the smallest resolvable object in the data.

For iterative restoration the Nyquist sampling rate is the minimum that is necessary; higher sampling rates will lead to superior deconvolution results.

For volume deconvolution lower sampling rates in z may be acceptable.

Sampling frequency in X and Y is determined by pixel size of the camera and objective magnification. Sampling frequency in z is determined by the distance between slices.

Sampling in x and y

Sampling frequency in x and y is determined by the spacing of the pixels on the camera.

sampling frequency = camera pixel size/total magnification

XY or lateral resolution: $d = 0.61\lambda / NA$

Where λ = wavelength and NA = numerical aperture of objective lens

Minimum sampling frequency in X and Y therefore = $d/2$.

If sampling frequency is less than or equal to d then sampling theory is obeyed.

Sampling in z

Find the depth of focus of the system and sample at half that distance.

A method of calculating DOF is:

$$l / 2NA^2$$

Where l = wavelength and NA = numerical aperture of objective lens.

Example

A sample labeled with GFP (emission wavelength 510nm) is imaged with a 63x oil immersion objective with NA of 1.4. The immersion medium has a refractive index of 1.518. The camera has a pixel size of 6.45 nm^2 .

XY or lateral resolution = 222 nm or 0.222 μm

Z or axial resolution = 130 nm or 0.13 μm

To follow the Nyquist theorem:

XY sampling = 0.111 μm

Z sampling = 0.065 μm

Based on the description above the camera will sample at 0.102 μm in X and Y therefore meeting the requirement for the XY sampling.

It is as important to sample accurately as it is to sample at the correct frequency. Always use a motorised stage, manual adjustment is not only tedious and slow, it is also not accurate enough.

Calculation of the optimum sampling rate will give results of very small values. If the equipment available cannot reproduce such fine movement, compromise is necessary to maintain accuracy. Sample at the smallest reproducible z step. Biological samples may not tolerate exposure to the excitation wavelength for the time necessary for such intensive sampling, and sampling ideals will again need to be compromised, as discussed below.

Avoid backlash in microscope focus mechanisms by moving against the load, or against gravity. Move the focus in one direction only during the acquisition. Once started never reverse the direction. To avoid backlash at the beginning of a stack focus to the first imaging point, move to below that start point then, back up to the start to capture the first frame.

Signal to Noise

Maximise the signal to noise ratio in images, use longest exposure possible which the sample will tolerate without bleaching.

Avoid pixel saturation; deconvolution will accentuate this and lead to blooming.

Perform background subtraction on images before deconvolution.

Spherical Aberration

Spherical aberration is asymmetry in the spread of light from a point source. It can be detected by viewing fluorescently labeled beads with the system. Focus through the beads and look for symmetrical spread of light on either side.

Use the correct cover slip. Lenses are designed for optimum performance when used with certain cover slips. A lens will not perform to its specification if used with a different thickness of cover slip.

Sampling Widefield Data for Deconvolution

Match refractive indices (RI) between sample, sample medium, immersion medium and lens. Mismatched refractive indices can cause spherical aberration and can lead to optical z section size varying from physical z step size, because the path of the emission light is changed at each boundary between different RI.

Try to ensure that all the materials that the light passes through are closely matched for RI.

It may be preferential to use a lower NA, water immersion lens which more closely matches the RI of a watery sample than an oil immersion lens. Also consider dipping objectives which are lowered into the medium surrounding the sample.

Vibration

Vibration of the acquisition system will cause lateral and axial shifts in the image acquired which will degrade the quality of the stack and the subsequent deconvolution. There is no way to correct for this; therefore, systems must be protected against vibration.

What Causes Axial Elongation of Structures in Optical Microscopy?

Overview

Fluorescently-labeled beads are used for a variety of purposes in optical microscopy, from measuring a point spread function to assessing the performance and calibration of the system. Beads supplied by manufacturers such as Molecular Probes are manufactured under strict controls and can be considered as spheres. Why then do 3D visualisations of these beads, reconstructed from 2D sections, appear not as spheres but as ovoid?

The reasons why beads might appear as ellipses instead of spheres in optical microscopy are different depending on the size of the objects being observed.

Working with Small Objects

The z (axial) resolution of a widefield or confocal microscope is normally three to four times less than its xy (lateral) resolution. In other words, the smallest object that can be resolved is approximately 200 nm in xy and 700 nm in z.

When working with small objects, such as 200 nm-point source beads for measuring a PSF, this effect is significant. The beads will appear to be three to four times elongated in z.

The elongation effect caused by the difference in resolution in z is only significant on small structures around the resolution limit of the microscope. It is a fact of optical microscopy and should be taken into consideration when interpreting data.

Working with Larger Structures

When working with larger structures ($>10\ \mu\text{m}$) you can sometimes also see elongation. The cause of this is normally different. It is due to a mismatching of refractive indices, either between the immersion medium of the objective and the sample medium or between the sample medium and the sample itself.

If the refractive indices are mismatched then the physical distance moved by the focus drive is not the same as the optical distance. This gets worse as you move deeper into the sample, away from the cover slip. Optical distance is less than focus drive distance and the result is stretching in z.

To minimize this effect we recommend that refractive indices are matched as closely as possible. For example if your specimen consists mainly of water and is mounted in an aqueous medium, it would be preferable to use a water immersion lens of a slightly lower NA than an oil immersion lens of the same magnification and higher NA.

Another factor which can also effect elongation is spherical aberration from high NA lenses. Most microscope manufacturers have special flat-field objectives that will reduce this effect. Consider evaluating lenses for spherical aberration before purchase.

These factors apply to structures within biological samples equally as to beads therefore they should be taken into account when interpreting 3D data.

OptiGrid® Structured Light Algorithm

Structured light illumination systems, such as the OptiGrid®, project a sinusoidal pattern onto specimens by placing a one-dimensional grating in the microscope's illumination path.

The grid is moved in the Y plane into three different positions and an image is acquired at each position. The following algorithm is then used to produce a single, derivative, confocal image from which the grid pattern has been removed.

$$\text{Confocal Image} = \sqrt{((I_1 - I_2)^2 + (I_1 - I_3)^2 + (I_2 - I_3)^2)}$$

I_1 = Image with the grid in position 1

I_2 = Image with the grid in position 2

I_3 = Image with the grid in position 3

	I_1	I_2	I_3	$(I_1 - I_2)^2$	$(I_1 - I_3)^2$	$(I_2 - I_3)^2$	Grid Image
Strongly Focused	1	1	0	0	1	1	1.41
Weakly Focused	0.8	0.8	0.2	0	0.36	0.36	0.84
Out of focus	0.5	0.5	0.5	0	0	0	0

Other sources of information

Improvision

TN424: A study of fluorescence standards confirms that OptiGrid® confocal images are suitable for quantitative microscopy

http://www.improvision.com/support/tech_notes/detail.php?id=424

Barlow and Guerin (2007)

Quantization of Widefield Fluorescence Images Using Structured Illumination and Image Analysis Software.

Microscopy Research and Technique 70:76-84

Neil MAA, Juskaitis R and Wilson T (1997)

Method of obtaining optical sectioning by using structured light in a conventional microscope.

Optics Letters 22: 1905-1907

Puch AC (2005)

Resolution Performance in Structured Illumination Microscopy: Comparison of OptiGrid® to Traditional Confocal Microscopes. Independent Resolution Testing.

Thales Optem technical note.

Index

- 3D FRAP, 234
- 3D menu, 327
- 3D toolbar, 329
- 3D view
 - contrast enhancement, 315
 - create bookmark, 332
 - movie interface, 98
 - scale, 328
 - view options, 328
- acquiring data, 47
- acquisition
 - adding points, 214
 - autofocus, 222
 - auto-focus, 303
 - capturing multiple channels, 191
 - data quality, 507
 - device controls, 156
 - devices, 152
 - events and logs, 194
 - fast restoration, 257
 - feedback, 193
 - focus limits, 223
 - optigrid, 266
 - preferences, 152
 - scanning, 218
 - set up protocol, 222
- acquisition examples
 - FLIP, 235
 - FRAP, 229
 - multi-point, 208
 - single point, 175, 228
 - xy stage, 208
 - acquisition protocol
 - elapsed time, 192
 - pause, 192
 - save, 190
 - time until next timepoint, 194
 - acquisition protocols
 - FRAP, 229
 - multiple channels over time, 293
 - multiple channels, multiple z-planes, 297
 - multiple channels, multiple z-planes over time, 301
 - single channel over time, 291
 - single channel, multiple z-planes, 295
 - single channel, multiple z-planes over time, 299
 - single frame, 290
 - acquisition setup dialog, 175
- activating products, 39
- add data
 - drag and drop, 48
 - image sequence, 55
- add points, 214
- adopt items command, 120
- align volumes, 344

- analysis examples
 - changes in intensity with object volume, 464
 - changes in object velocity over time, 465
 - mean intensity of objects, 458
 - mean number of objects per cell, 459
 - total number of objects measured, 454
 - total number of objects measured per timepoint, 456
- analysis view, 450
- angle, 447
- aperture diaphragm
 - adjusting, 282
- auto analyze, 424
- auto contrast, 122
- auto contrast command, 120
- autofocus, 184
- autofocus, 222
- auto-focus, 303
- axial elongation, 527
- background corrections
 - creating, 129
 - FRAP, 484
 - inspecting, 132
 - why it is needed, 128
- batch processing
 - auto contrast, 120
 - change colors, 123
 - measurements, 432
 - photobleaching, 485
 - restoration, 512, 515
 - using ICS, 33
- batch processing, 120
- bearing, 447
- bleed-through constants
 - fret analysis, 499
- bookmarks
 - create, 332
 - definition, 97
 - delete, 335
 - edit, 334
 - move, 334
 - show, 327
 - use, 334
- bright reference images, 130
- brightfield reference image. *See* reference image
- calculate object colocalization, 424, 483
- calculate psf, 509
- calibrate
 - objective lens, 163
- calibration
 - MicroPoint, 285
 - optigrid, 266
 - photokinesis accessory, 204
 - spatial, 163
- capture
 - image sequences, 191
 - snapshot, 117
- capturing channels, 177
- capturing images. *See* acquisition setup dialog
- capturing with XY stage, 181
- capturing z stacks, 178
- CCD active area, 173
- centroid, 423, 446
- change size command, 124

- changes in intensity with object volume, 464
- changes in object velocity over time, 465
- changing object colors. *See*
- channel
 - compress, 113
 - target, 388
- channels, 166
- chart examples, 470
- chart types, 469
- chart view, 468
- clear movie, 103, 341
- clip objects to ROI, 415
- cloak command, 125
- close
 - library, 47
- close library, 47
- close objects, 413
- colocalization, 424
 - automatic thresholding, 477
 - generate, 481
 - global statistics, 480
 - in ROI, 478
 - measure object, 483
 - PDM, 482
 - practical considerations, 483
 - references, 481
 - scatter plot, 474
 - statistics, 479
 - statistics, 479
 - thresholded statistics, 479
 - thresholds, 475
 - worked example, 376

- colocalization, 472
- colocalization menu, 472
- colocalization toolbar, 472
- colocalization view, 376, 473
- color balance command, 125
- color depth command, 122
- color objects, 426
- color reference
 - FRET, 504
 - ratio, 497
- colors command, 123
- Columbus, 50
- combine objects, 418
- comment, 426
- compact library command, 70
- compress channels, 113
- Computing Server, 33
- connecting optigrid
 - manual focus model, 263
 - motorized focus model, 260
- contrast enhancement
 - video preview, 172
- contrast enhancement, 315
- contrast enhancement command, 126
- copy
 - between libraries, 66
 - items, 68
 - timepoints, 110
- correct background command, 132
- correct registration command, 137
- create
 - background corrections, 129

- bookmark, 332
- folders, 66
- image sequence, 55
- library, 43
- protocol, 346
- QTVR movie, 327, 342
- registration corrections, 134
- spectral signatures, 247, 249
- volume, 56
- crop to selection command, 140
- dark reference images, 131
- data
 - normalize, 452
- data calibration, 508
- delete items, 69
- delta, 446
- device controls
 - most used, 158
- device controls, 156
- device latencies, 165
- device preferences, 153
- devices
 - installing and configuring, 152
 - setup, 155
- devices, 199
- dichroic, 200
- dilate objects, 414
- discrimination mode, 199
- displacement, 447
- dongle, 29
- duration, 181
- elevation, 447

- erode objects, 414
- event flag, 194
- exclude non-touching objects, 419
- exclude objects by shape, 416
- exclude objects by size, 417
- exclude objects not touching roi, 417
- exclude objects touching edge, 418
- exclusively combine objects, 419
- experiment duration. *See* duration
- export
 - as AVI movie, 148
 - as QuickTime movie, 148
 - images, 145
 - measurements, 439
- exposure controls, 159
- fast restoration
 - acquisition, 257
 - applying, 512
 - description, 507
 - ICS, 33
- feedback
 - acquisition, 193
 - change object colours, 440
 - measurement objects, 394
 - not displayed, 443
 - options, 440
 - raw view, 439
- feedback options, 441
- file formats, 59
- fill holes in objects, 414
- filter measurement data, 435
- filter measurements, 421

- filter wheel, 159
- filters, 155
- find 2D nuclei, 404
- find 2D spots, 404
- find command, 68
- find objects in roi, 408
- find objects using % intensity, 405
- find objects using hsi, 409
- find objects using intensity, 407
- find objects using rgb, 411
- find objects using sd intensity, 412
- FLIP, 235, 486
- FLIP acquisition example, 235
- fly-around tool, 329
- focus, 178
- focus controls, 160
- focus limits, 223
- folders
 - copy and move, 66
 - create, 66
- FRAP
 - acquisition protocol, 229
 - background correction, 484
 - measurement item, 491
 - normalization, 485
 - photo-bleaching correction, 484
 - references, 486
- FRAP, 226, 228, 229
- FRAP acquisition
 - overview, 226
 - preparing experiment, 228
 - preparing for, 228
- FRAP acquisition example, 229
- FRAP analysis, 484
- FRAP analysis, 485
- FRAP Preview, 226
- free flight camera control, 330
- freezing video preview, 192
- FRET, 499
 - color reference, 504
 - data acquisition, 499
 - references, 499
- fret analysis
 - applying calculation, 501
 - bleed-through constants, 499
- fret analysis, 498
- FRET analysis
 - data acquisition, 499
 - measuring channels, 504
- fret dialog, 501
- gamepad, 330
- genate colocalization, 481
- grid AF, 272
- grid confocal images
 - capturing multi-channel, 279
 - capturing single channel, 275
- grid controls, 272
- grid modes, 273
- group measurements, 426
- grynkiewicz equation, 498
- hand tool, 89
- hints
 - enabling and disabling, 33
- histogram, 382, 399

528 Improvisation

- ICS, 33
- Illumination correction, 518
- IM image, 504
- image menu, 92
- image sequence, 42
 - create new, 55
 - measure multiple, 359
- image sequences
 - capturing, 191
- image view
 - measurements, 382
- import
 - preferences, 48
- import command, 57
- important concepts, 42
- install
 - MicroPoint, 284
- installation
 - dongle, 29
 - server systems, 30
 - single license, 29
 - starting after, 30
- intensity modulated images, 505
- intensity profile. *See* line profile
- internalize measured objects, 420
- intersect objects, 420
- invert objects, 420
- iterative restoration
 - applying, 515
 - description, 507
- Iterative Restoration, 33
- join objects, 437
- joypad, 330
- joypad preferences, 330
- keyframe
 - create, 99, 337
 - edit, 101, 339
- kymograph, 392
- lambda stacks, 253
- laser lines, 159
- laser power, 200
- lasso tool, 89, 386
- library
 - compact, 70
 - creating, 43
 - definition of, 43
 - format, 62
 - menu, 63
 - organizing data in, 61
 - selecting items, 74
- Library
 - opening, 46
- library thumbnails, 64
- library view, 42, 62, 72
- license server
 - change password, 32
 - installing Volocity with, 30
 - switching to individual license, 32
 - switching to server, 32
- light path manager, 166
- light path settings, 168
- line profile, 95
- line tool, 383
- logs, 194

- magic wand tool, 90, 387
- magnifying tool, 89
- make measurement item, 398, 433
- make movie, 105, 341
- make roi from objects, 427
- make volumes command, 56
- make well overlay, 211
- mean intensity, 445
- mean intensity of objects measured, 458
- mean number of objects per cell, 459
- measure
 - selected timepoints, 399
- measure and track multiple timepoints, 366
- measure channels
 - ratio, 497
- measure device latencies command, 165
- measure FRET channels, 504
- measure line profiles, 421
- measure lines, 421
- measure multiple image sequences, 359
- measure multiple timepoints, 350
- measure objects, 422
- measure objects command, 351
- measure points, 423
- measure psf
 - sampling, 523
- measure psf, 511
- measure single timepoints, 346
- measure skeletal length, 424
- measurement columns, 434
- measurement item, 491
- measurement item, 349, 398, 433

- measurement protocol, 401
 - batch processing, 432
 - clear, save, restore, export, 430
- measurement protocol, 346
- measurement protocol tasks, 402
- measurement table, 433
- measurements
 - count points, 385
 - definitions, 444
 - draw lines, 384
 - draw regions, 386
 - export, 439
 - feedback, 439
 - feedback options, 397
 - filter data, 435
 - histogram, 382, 399
 - image view, 382
 - join objects, 437
 - object feedback, 394
 - view options, 398
- measurements menu, 396
- measurements view
 - feedback options, 440
- measurements view, 382
- merge channels command, 109
- merge planes command, 141
- MicroPoint, 284
- minimum system requirements, 29
- move
 - folders, 67
 - items, 68
- movie

530 Improvisation

- clear, 103, 341
- make, 105, 341
- resize, 103, 341
- save and restore, 104, 342
- movie interface, 98
- multiple channels over time acquisition, 293
- multiple channels, multiple z-planes acquisition, 297
- multiple channels, multiple z-planes over time acquisition, 301
- multi-point acquisition example, 208
- noise, 525
- Noise, 33
- normalization
 - FRAP, 485
- normalizing data, 452
- notes view, 116
- Nyquist theorem, 524
- objective lenses, 163
- offsets, 132
- open
 - library, 46
- open objects, 414
- optigrid
 - calibration, 266
 - capturing multi-channel grid confocal images, 279
 - capturing single-channel grid confocal images, 275
 - connecting manual focus model, 263
 - connecting motorized focus model, 260
 - grid controls, 272
 - how to use, 272
 - manual focus model preferences, 266
 - motorized focus model preferences, 265
 - structured light algorithm, 528
 - troubleshooting grid imaging, 282
 - troubleshooting installation and calibration, 269
- optigrid, 259
- overlays
 - save and restore, 213
- overlays, 211
- page setup command, 145
- pan tool, 89
- parent ID, 444
- pausing acquisition protocol, 192
- PDM, 482
- photo-bleaching correction
 - FRAP, 484
- PhotoKinesis accessory, 202
- pivotal point of rotation, 330
- point tool, 385
- points
 - inspect and edit, 216
 - random, 215
 - save and restore, 218
 - scanning, 220
- points, 214
- preferences
 - after installation, 32
 - for acquisition, 152
 - import, 48
 - joypad, 330
 - optigrid manual focus model, 266
 - optigrid motorized focus model, 265
 - photokinesis accessory, 202

- UltraVIEW, 197
- print, 145
- print preview, 145
- product of difference from mean. *See* PDM
- programming acquisition. *See* acquisition setup dialog
- properties, 65
- protocols
 - setup and run, 222
- psf
 - calculate, 509
 - measure, 511
- QTVR movie, 327, 342
- quantitation
 - measure and track multiple timepoints, 366
 - measure multiple image sequences, 359
 - measure multiple timepoint, 350
 - measure single timepoint, 346
- quit Volocity, 37
- ratio, 237
 - acquisition protocol, 242
 - preparing experiment, 241
 - preview, 237
- ratio preview, 237
- ratioing
 - apply calculation, 494
 - measure channels, 497
 - measuring channels, 497
- raw data view, 434
- reference channel, 76, 96, 315, 319, 325
- reference image, 77, 85, 130, 186, 315, *See* reference channel

- regions of interest. *See* ROI
- registration corrections
 - automatically create, 135
 - inspecting, 136
 - manually create, 135
- registration corrections, 134
- remove items command, 69
- remove noise command, 142
- remove noise from objects, 415
- renderers
 - selecting, 307
- rendering view, 306
- resample timepoints command, 111
- resize movie, 103, 341
- restoration
 - data quality, 507
 - types of, 507
- Restoration, 33
- restore objects, 427
- retain objects, 427
- reveal in finder/explorer command, 70
- ROI, 391
- roi options, 91
- roi tools, 89, 386
- rotate slice tool, 321
- rotate volume tool, 323
- rules, 187
- sampling
 - depth of scan, 523
- sampling for deconvolution, 523
- sampling frequency, 524
- save and restore movie, 104, 342

- save settings. *See* Bookmarks
- saving acquisition protocol, 190
- scan points, 220
- scanning, 218
- scatter plot, 474
- selecting camera input, 170
- selection tools, 89, 90
- separate color images, 251
- separate monochrome images, 253
- separate touching objects, 415
- serial ports preferences, 152
- session log, 36
- shading defects, 128
- show color reference command, 93
- show data command, 117
- show in library command, 70, 116
- show scale command, 95
- show time command, 93
- shutter, 162, 179
- shutter controls, 162
- shutter management. *See* device latencies
- single channel over time acquisition, 291
- single channel, multiple z-planes acquisition, 295
- single channel, multiple z-planes over time acquisition, 299
- single frame acquisition, 290
- single point acquisition example, 175
- size
 - changing, 124
- skeletal length, 445
- slice view
 - create data, 324
- slice view, 320
- slicing orientation, 321
- sliders, 163
- smooth zoom command, 92
- snapshots, 117
- software updates
 - automatic check, 33, 37
 - license server, 38
- software updates, 37
- sort by command, 117
- spectral separation, 245
- spectral signatures
 - create from color, 247
 - create from monochrome, 249
 - separating color, 251
 - separating monochrome, 253
- spherical aberration, 526
- spinning disk, 510
- spinning disk illumination, 196
- split multi-colored items command, 139, 143
- split volumes command, 141, 143
- spot bleaching, 172
- stage setup, 208
- starting Volocity, 30
- statistics
 - colocalization, 479
- statistics, 479
- status bar (Windows), 74
- stitch, 183
- storing measurements, 433
- subtract objects, 420
- supported file formats, 59

- surface area, 423
- target channel, 388
- technical support, 28
- thresholds, 475
- thumbnails
 - in library, 64
- tile channels, 171
- timelapse, 180
- timepoint sequence
 - add, 99, 338
 - edit, 102, 340
- timepoints
 - absolute or relative, 109
 - measure and track, 366
 - measure multiple, 350
 - measure single, 346
 - resample, 111
- total number of objects measured, 454
- total number of objects measured per timepoint, 456
- track ID, 444
- track multiple timepoints, 366
- track objects
 - automatically join broken tracks, 428
 - trajectory variation, 428
- track objects, 427
- track objects, 429
- track objects task, 369
- triggering events. *See* rules
- troubleshooting
 - grid imaging, 282
 - optigrid installation and calibration, 269
 - session log, 36
- TTL controls, 163
- UltraVIEW, 196-201
- undo command, 120
- unlock codes, 39
- using the optigrid, 272
- vibration, 526
- video feedback, 174
- video preview, 156, 170
 - CCD active area, 173
 - centering XY stage, 172
 - contrast enhancement, 172
 - cropping, 172
 - freeze, 192
 - intensity, 174
 - signal to noise, 174
- view
 - 3D, 306
 - analysis, 450
 - chart, 468
 - colocalization, 376, 473
 - export as AVI or QuickTime movie, 150
 - library, 62, 72
 - measurements, 382
 - notes, 116
 - raw data, 434
 - rendering, 306
 - slice, 320
 - xy stage, 209
- view options, 96
- view tracks, 436
- visualization, 305
 - bookmarks, 332

534 Improvisation

- rendering and 3D view, 306
- set pivot for rotation, 330
- Volocity
 - important concepts, 42
 - quitting, 37
- volumes
 - align, 344
 - create, 56
 - split, 143
- voxel spy, 172
- well plate, 211, 217

- wells
 - overlays, 211
 - scanning, 219
- XY focus maps, 216
- XY stage
 - centering on video preview, 172
- XY stage, 208
- xy stage view
 - add overlays, 211
- XY tiling. *See* stitch
- zoom tool, 89

